

## **PART FUNCTIONAL AND GEOMETRIC KNOWLEDGE MODELING FOR DESIGN PRODUCT**

**LINHARES, Joao Carlos, [joaoCarloslinhares@gmail.com](mailto:joaoCarloslinhares@gmail.com)<sup>1</sup>**  
**DIAS, Altamir, [altamir@emc.ufsc.br](mailto:altamir@emc.ufsc.br)<sup>2</sup>**

<sup>1</sup> Universidade Federal de Santa Maria – UFSM, Av. Roraima, 1000, CEP: 97105-900, Camobi, Santa Maria – RS

<sup>2</sup> Universidade Federal de Santa Catarina – UFSC, CP 476, CEP: 88040-900, Trindade, Florianópolis – SC

**Abstract:** *The 3D geometric modeling can be accomplished from the functions description executed for the parts that integrate the products technical systems. When a functions group with design meaning can be, in some way, converted in a solid geometry, we will be a new paradigm eyewitness in the mechanical design: the product design from the function-form transformation. Certainly, any attempt will have to pass for the writing processing of the phrase that identifies the function. Parts have associate elementary functions to its constructive details. Therefore, it's necessary before, to subdivide the part phrase functional structure for later, to accomplish the part set geometric modeling, that are inter-related to realize the global function. In recent years we research about this. A first step, to a large extent, the attempts are in the direction to discover a clear-cut syntactic standard to create the functions description and to obtain correlations between the phrase structure design meanings to the product application domain. Thus, it was discovered that repetition standards exist and can be associates to one or more elementary solid geometries, such as groove, hole, groove, round, chamfer, and others. This correlation can lead, initially, to the probable solid geometries that accomplish the desired functions to the product.*

**Keywords:** functional modeling, word repetition standard, design intentions

### **1. INTRODUCTION**

This article analyzes the current advances in the research on mapping the "shape function" whose goal is to re-organize the computational implementations previously performed in Linhares (2005), now based in a technical terminology which operates the relations between the geometric details of parts and its functional description areas, looking for to search repetition patterns language that directs the choice of parts basic geometry solid modeling.

Implementations carried out in Linhares (2005) describe various correlations between functions structures, material regions, and solid features sequences. The implementation becomes possible to filter and identify some repetition patterns determined from correlations between phrasal components of descriptive structures and associate with meaning functions, physical regions and corresponding solid features of the geometry model created in CAD systems. However, each time a certain type of solid geometry or solid feature is required by the functional description, based on design intent, it is very likely, given the repetition patterns, that a given functions set can be performed by it. The repetition patterns implemented computationally were the first indicators that there is a way to get to the part solid geometry. The pattern is found from the part functional description, where semantics composition were identified such that they lead to geometries alternative and associated with respective required set of functions. It also was noted that these repetition patterns can be help to find preliminary solution principles during the design when all description are linked to terminological similarities verification. In several design processes the phrases used by designers to describe and communicate intentions and solutions contain verbs nouns and qualifiers (VNQ). Those descriptions, phrasal structures and the terms used belong to the part preliminary solution principles chain.

Since the designer must study advance in an attempt to view any geometric form and the part "behavior in use" in the mechanical system or sub system that will perform their functions, the knowledge about part preliminary solutions principles (Pp's) was organized to help to define functions. This way to think facilitates the designer to find geometric solutions, physical region or detail to a part. Shortly, one can say that the repeated patterns depend very little on the type of product or application domain, that is, the part details final geometries are largely associated to specific design requirements and pre-defined for the part in the assembly in carrying out their functions. In some study case, the functions described by the designers will lead to the same repeating patterns as will be demonstrated in text. In this paper will be emphasized functions descriptions made for an off-road Baja vehicle.

The functions description used in the paper was suggested by two set of designers: the designers that works at the Brazilian Compressors – EMBRACO, located in Joinville, SC, Brazil and by engineering students of of the Mechanical Engineering Department at Institute Tupy (IST) and Educational Society of Santa Catarina (Sociesc), Boa Vista, Joinville, SC, Brazil.

## 2. RESEARCH BACKGROUND

The study models are part of the interface between conceptual and preliminary design phases in the Pahl/Beitz design methodology process where the transition function-form question have been strong importance in the design process. This paper was written to readers that know about design methodology researches.

### 2.1. Models study at interface conceptual/preliminary function-form

2D and 3D parts geometric modeling begins in the product conceptual definition where preliminary definitions to give shape to a part and after to the product take place. So, most of users and design requisites have to take in account to produce the objects embodiment in accord of solution principles chosen. Users and design requisites has to transform in function description and those in the solid modeling details of each parts, to the group of parts and finally to each details of the product. In the product development process, a reference model (PDPMR) was proposed in Back et al. (2008) and implemented by NeDIP research group, in which, like Pahl and Beitz, the process may be is broken down into several tasks with inputs and outputs, and so, providing mechanisms to accomplish each task in design of a product. One of these tasks is to establish the functional defining basis in the product level..

Hundal (1990) has written about the systematic design method proposed by Rodenacker (1984) and Pahl & Beitz (1988). They appointed scientific procedures to aid the new products and processes development. Based on principles (physical, chemical, biological) rather than pre-conceived solutions and existing products and highlights some important features of the method as: (1) Abstraction of the application requirements that reduce the overall problem in terms of ready solutions; (2) macro problem deployment in sub-problems and search for more than one solution for each; (3) Sub-solutions combination that can generate variant solutions to the global problem, and (4) Emphasis on the best physical processes selection in which the design is based. In the functional/conceptual design stage the models are representatively symbolic, descriptive and semantic. In the preliminary design, the product is represented by 2D and 3D sketches. Roth (1985) *apud* Hundal (1990) shows that in functional/conceptual design and preliminary design, the product model description (PMD) can be represented in the computer for product data definition (PDD).

Deng et al. (2000), warn the importance of the functional deployment and constraints definition between the product physical components elementary functions. The authors use the design model "Function-Environment-Behavior-Structure – FEBS", to represent the product functional inputs and outputs. Case & Hounsell (2000) present a methodology used to validate a representation based on *features* that capture the designer intentions related to the part geometry functional, relational and volumetric aspects. Roy et al. (2001) proposed a method to design synthesis by part functional requirements mapping which is done in a restrictions multi-stage optimization during the design process stages. This function-form mapping can replenish the product design specification, altering and optimizing the organizational structure from product level to part level.

Hubka & Eder (1988) use the term "action mode" and emphasize that the technical systems components must be developed simultaneously and indicate that before describing functions is necessary to understand the design principles associated with carrying out those functions. Pahl et al. (2005) propose preliminary design guidelines. These guidelines can be considered as parts preliminary design principles. They are: thermal expansion, creep and relaxation, corrosion, wear, form, manufacturing, maintainability, recycling, safety factors and technical standards. These requirements can compose a checklist for the designer serving as a guide in parts functions defining. Linhares and Dias (2001a, 2001b, 2003a, 2003b) have written several papers presenting an approach to the development of a computational framework for modeling part functions to achieving a correlation model between the functional and geometric domain in the product preliminary design stage, following the Pahl & Beitz (1996) methodology.

### 2.2. Applied research process information

The design process is a dynamic process, in which the design information is updated continuously in each design activity. Some studies, from design processing information point of view, have been completed and published, among which are presented the most relevant ones for this research. Bouzeghoub, (1997), points to the importance of promoting the use of natural language as language specification and query databases. Points out important projects dedicated to language dictionaries definition from the end of 80 years in many research laboratories, but the result spread was limited to specialized communities. Formal languages, which are sets of words built on an alphabet, are specific languages used in the context grammars preparation. They have specific semantics and syntax fixed or standardized, there are no ambiguities. However, attempts to translate formal expressions into knowledge concepts or cognitive, often result in failure.

## 3. THE PART MECHANICAL DESIGN FUNCTIONAL SPACE

The hierarchical classification is widely used in the physical objects representation and their corresponding meanings and implications in the field of functions in the mechanical design. In Table (1) is showed a way to classify design functions applied to the design process. This compilation proposal was made from several readings where various types of functions classifications was been proposed by authors in the literature. In the table are evidenced the comparison between the classifications most commonly used for systematic functional design process. This work uses a

hierarchy that includes the product global function (*GF*), the partial functions (*PF*) and the elementary functions (*EF*), applied to parts in particular. It can be seen in Tab. (1) that all types of classification are extended to parts, since the rankings by "geometry form" type and "manufacturing process" type are important in the integration processes mapping and representation between design and manufacturing, particularly in the CAD/CAM systems.

### 3.1 - Functional and physical descriptive structures representation models

The research on part functional descriptions has evolved in recent years to give a way to get a design function representation models in order to identify the physical and functional hierarchies at product abstraction levels. Many authors have written and agreed to the fact that the function based design is important in geometry form defining and product and parts layouts. Also, they believe about the necessity to represent the product functions, either through a graphical model, or computationally or yet in a database resource. These techniques facilitate understanding and verification of inter-functional relationships, and providing a better use behaviors visualization and anticipation.

**Table 1. Overview with various design functions classifications collected the theoretical review.**

Classification	PRODUCT	ASSEMBLY	PART
Hierarchical	Global Function ( <i>GF</i> )	assembly Global Function ( <i>aGF</i> )	part Global Function ( <i>pGF</i> )
	Partial Function ( <i>PF</i> )	assembly Partial Function ( <i>aPF</i> )	part Partial Function ( <i>pPF</i> )
	Elementary Function ( <i>EF</i> )	assembly Elementary Function ( <i>aEF</i> )	part Elementary Function ( <i>pEF</i> )
Geometric form	rotational Function ( <i>rtF</i> ); prismatic Function ( <i>prF</i> ); laminar Function ( <i>laF</i> ); mixed Function ( <i>ixF</i> )		
Type of part application	mechanical Function ( <i>mcF</i> ); hydraulic Function ( <i>hdF</i> ); pneumatic Function ( <i>pnF</i> ); electroelectronic Function ( <i>eeF</i> ); informatica Function ( <i>ifF</i> )		
Manufacturing process	stamping Function ( <i>stF</i> ); sintering Function ( <i>siF</i> ); machining Function ( <i>mcF</i> ); casting Function ( <i>ctF</i> )		
Complex level	Product Functions ( <i>F<sub>p</sub></i> ): mechanical systems composed of assemblies and parts	Assembly Functions ( <i>F<sub>a</sub></i> ): simple mechanical systems that can also carry a larger functions group.	Part Function ( <i>F<sub>m</sub></i> ): elementary systems, manufactured without assembly operations.
Qualification	Primary Function ( <i>PrF</i> ); Secondary Function ( <i>ScF</i> ); Accessory Function ( <i>AcF</i> ); Derived Function ( <i>DeF</i> ):		
Action mode	fastener Function ( <i>F<sub>x</sub></i> ); support Function ( <i>sF</i> ); transmission Function ( <i>tF</i> ); transport Function ( <i>pF</i> ):		
Descriptive representation	Function describe by verb ( <i>F<sub>v</sub></i> ); Function describe by verb and noun ( <i>F<sub>s</sub></i> ); Function describe by verb, noun and qualifier <sup>(1)</sup> ( <i>F<sub>q</sub></i> ).		

Considering the part and product physical levels is possible to represent the functional correlation as shown in Figs. (1) e (2). Figure 1 shows the corresponding UML representation of the product physical and functional levels and Fig. (2) shows the UML representation of the part physical and functional levels. The small diamond between representations frames of each functional and physical level mean the associated representation table aggregation. This means that a PRODUCT is made up of ASSEMBLY aggregations. The recursion symbol in the representative framework of ASSEMBLY means that one new ASSEMBLY can be formed by aggregations of the several other assemblies (subassemblies), and finally, the last level of representation is one ASSEMBLY (subassembly) composed of the PARTS aggregations. The physical representation levels have their respective functional representation levels. Thus, the frame top right of Fig. (1), represents the Global Function level (*GF*). This representation uses the same composition logic used for the corresponding product physical levels representation. The Global Function (*GF*) adds Partial Functions (*PF*), which in turn adds Elementary Functions (*EF*), all related to the product as a whole.

The product physical level representation is best known in the scientific community that studies product hierarchical physical models. The second representation is not clear because of the need to represent the product physical levels beyond the part specific representation. Part contains geometric features essential to the performance in its life cycle. The aim is to express the part functional specificities part in terms of the design process final stages where the geometric details definitions have a close relationship with the material, resistance, dynamic requests, definitions, among other part specific requirements. The representation used for product can now be reused in the physical regions representation and part functions representation, as shown in Fig. (2). The striking difference between the two representations types are in fact part be a single object in which the aggregates are not composed of distinct physical objects but part distinct physical regions. Thus, the various part functional regions are aggregated to compose the part whole and the different physical details are added to form different functional regions. This leads to the corresponding functional levels, represented in the Fig. (2) tables as part Global Function (*pGF*), part Partial Function (*pPF*) and part Elementary Function (*pEF*) that respectively correspond to the part physical levels part Functional Region (*pRF*) and Detail (*det*), which refer to the geometric details that make each part functional region.

### 3.2. – Descriptions Model – (VNQ)

<sup>(1)</sup>The qualifier may consist of verbs, nouns, adjectives, adverbs, etc..., allows the functional description refinement.

The phrasal descriptive structure organization proposal provides that a grammatical components logical sequence of, containing the design intentions, can be described on a standard grammatical composition. For example, in the part function description case, this pattern is composed by the sequence "verb + noun + qualifier" (VNQ). The verb expresses the action to be undertaken by the hierarchical level corresponding to the physical model adopted. The noun is the object upon which the verb action concerns and the qualifier specializes the designer intention, because it embeds the other part design requirements. Thus, the format or grammatical sequence can lead the designer to describe the functional need for an organized way in order to standardize the functional structure in design significance terms.

This standardization extends to physical regions descriptions and solid features sequences. In both cases, the description composition uses only the noun and the qualifier in their descriptions. The physical region description is more appropriate to colloquial patterns in design engineering domain and the solid features sequence description begins with the grammar used in the CAD system user interface user. One is characterized by the design intent, the other by the way the CAD system developer displays the embodiment of these intentions. Both are built on different linguistic corpora, but that converge towards the same goals, the systematic mechanical design.

In this research, the mechanical design domain linguistic corpus, ie, the terms used in the language composition being considered, are verbs, nouns and qualification components or qualifiers, in turn composed of nouns, adjectives, adverbs and other grammar components, which characterize the functional design semantics and even the technical terms that identify the 3D geometric operators. The function descriptions, physical regions and solid features sequences models, called linguistic model, assumes that the descriptive structures are defined composition standards-based, that is, each descriptive structure is composed in accordance with its corresponding composition standard. The representation models that correspond to the composition standards are introduced in the following sections.

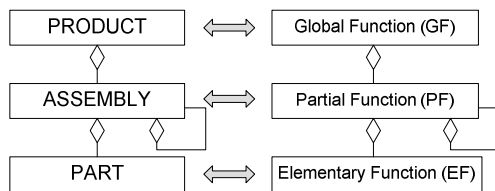

Figure 1. Product physical and functional levels UML representation.

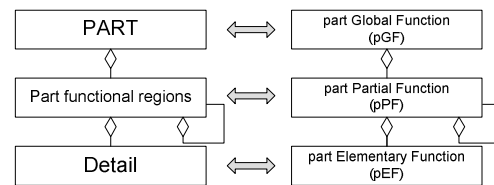

Figure 2. Part physical and functional levels UML representation.

### 3.2.1 - Part functions description

The part function description is made on the basis of design requirements related to the assembly in which it is associated, in the light of the designer intentions. Currently, a large number of parts are specified commercially. However, the parts design to be manufactured is still a worrisome task for mechanical designers. One way to organize information is to describe the functional structures required by parts as a starting point the part global function. In functions describing of the part functional description structure, the description grammar rule is valid for all functional description levels in their tree. Once the functions descriptions and physical regions are made based on a hierarchy tree, each tree node will contain a function description at the corresponding level. Figure (3) shows the composition pattern representation on which the functional descriptions should be made.

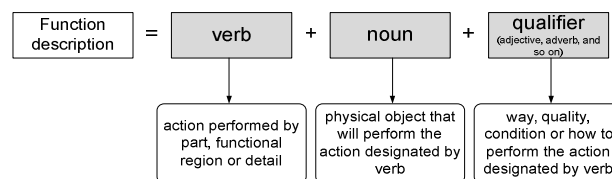

Figure 3. Representation of the basic structure to part function description.

### 3.2.2 - Part physical regions description

The part physical regions description is now simpler than its functional description. It needs only a description with nouns and qualifiers. The physical regions model divides the part in three levels: the level of "part", the level (or levels) of "functional region", and level of "detail", comprising the functional region, as shown in Fig. (2). The term "part physical region", to the detriment of the term "part functional region" assumes that the part can be broken down into different physical elements in terms of part location. Just as the described functional structures in the hierarchical trees form, the part physical regions are described here in the same representation model. Relationships are  $n:n$ , that is, the part functions descriptions in the space of functions correspond to the descriptions in the part levels, functional region or detail in the physical representations descriptions domain, and vice versa. This relationship type can be differentiated and take relations as  $m:n$  or  $n:m$ , where  $n \neq m$ . However, we chose to study the  $n:n$  relationship whereas the functional structure description will have the same hierarchical tree that the part physical structure description, eg, for each desired

function, a particular geometric detail be required. The regions physical tree shows the descriptions taken to the solid geometric components to be modeled after in CAD system after for 3D solid features. Therefore, the phrasal composition main component is the verb that is either concrete or abstract. Sentences or phrases should be constructed according to the composition standard given by a noun and a qualifier, as shown in Fig. (4).

### 3.2.3 – Solid features description

The model language or descriptions is complemented by the description of the operations to create geometry in 3D CAD system, here called solid features. The solid features or 3D geometric modeling operations used to create geometry of each part are described on the basis of technical terms proposed in the solid geometry standard definition. However, to make this description, it is necessary to use consistent terminology to relate the solid features field. Figure (5) shows the representation of this descriptive composition pattern.

### 3.2.4 – Components language to describe form function

Verbs design used in the part details functional description (part elementary functions), physical regions (part partial functions) or part a whole (part global function), are defined in the verbs dictionary. In it, the verbs contained in the technical language of a given design scope, can be added, removed or replaced for the design intended descriptions composition, in terms of functions.

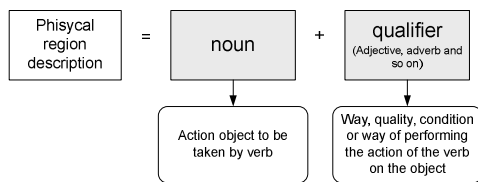

Figure 4. Basic structure representation for part physical region description composition.

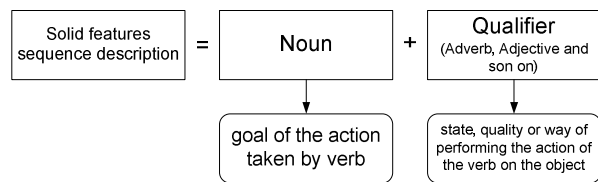

Figure 5. Basic structure representation for the part physical region description composition

Table (2) shows some examples of design verbs used in actions descriptions necessary to functions realizations. The proposal database implementation contains the full of the verbs listed in linguistic corpus implemented and can be implemented by means of computer interfaces to aid the mechanical designer.

Table (3) shows some examples of design nouns used in the physical regions descriptions and solid features necessary for the functions realization. Also, the implementation database contains the full of the nouns contained in the linguistic corpus implemented and can be implemented by means of computer interfaces to aid the mechanical designer. We identified a set of values of that component to the descriptive structures composition that could represent some design intentions. As in the descriptive components values dictionaries, other values understood as used in the description of these elements can be inserted during the functional design activity.

Table 2. Design verb list.

absorb	speed	set	housing	balance
trigger	add	feed	cushion	pump
engage	admit	align	enlarge	capture
join	compress	connect	control	convert
srt	lead	derive	untie	download

Table 3. Design noun list.

lamp	foundation	ring	arrangement	base
finish	food	bulkhead	washer	stop
coupling	relief	support	sprinkling	rod
removal	socket	area	actuator	block
agitation	damping	aro	balancing	pump

Some of the qualification values that have been used in this research are listed in Tab. (4). The implementation database contains the full qualifiers listed in the linguistic corpus and can be implemented by means of computer interfaces to aid the mechanical designer. Examples of grammatical forms values or words classes that are related to the mechanical design domain are shown in Tab. (5).

The idea is that a set of terms, technical or otherwise, is used each time a part belonging to an application domain particular, should be designed. In the future, this will greatly assist in the solid geometry automated definition based on functional descriptions. The designing habit based in the functions domain on a standard wording allows for better familiarity with the technical terms used within the scope.

### 3.3 – Preliminary design principles representation model (Pd's)

Functions descriptions carry application domain design meanings, thus the definition of solid geometry that realize they are attached. The meanings design embedded in functions descriptions can lead to the choice of geometrical forms for the corresponding physical solution, ultimately, the designer design intentions. With this approach, we seek new correlations for the solid geometric form definition from the behavior in use analysis of the device through the physical,



chemical and biological effects observation needed to technical system parts functions. Before describing the part features by watching the behavior in use with the aid of preliminary design principles the designer can enter a descriptive model describing the function to be performed. In any procedure for establishing the physical configuration is experienced initially by specification (dimensions definition), together with the material choice, to meet function with the operation principle selected. Often, this occurs with the support of a draft specification that enables the first representation in scale and a space compatibility rough assessment. Subsequently, security aspects of man-machine interface (ergonomics), manufacturing, assembly, operation, maintenance, recycling and the costs and delays involved, play an important role, (Pahl et al., 2005).

**Table 4. Design qualifiers.**      **Table 5. Objects that contain the grammatical forms values in mechanical design.**

horizontally
alternative
angular
angularly
previous
previous valve
horizontal
inclined
lower
assembly

Nº	word class	possible value
01	adjective	perpendicular, axial, smooth, straight, knurled, grooved,
02	adverb	perpendicular, axially, above, before, in, out, horizontally
03	article	the...
04	conjunction	and, or, what, as, since, though, as, which, as...
05	numeral	one, two, thirteen, twelve hundred, first, sixty, third, ,
06	preposition	since, between, until, against, without, under, about, on, in,
07	pronoun	my, this, he, all, some, several, both, any, much...
08	noun	coupling, gear, screw, rod, torque, rotation, shaft, pulley,
09	verb	adjust, filter, position, retain, transmit, pull, merge...

In observation of these effects is possible to predict the phenomena involved and to determine the types of the dynamic or static applications that occur in the technical system mechanisms for its implementation. This analysis leads to the choice of requirements design that are preliminary design principles (*Pd's*) to be considered in the part details solid geometric forms definition and establishment from a part functional structure appropriate description. Therefore, the preliminary design principles guide the final solid geometry form definition can be regarded as terminology conductor elements of solid geometry toward the global geometry more appropriate for the attainment of the part functional structure from the descriptions made by designer in the descriptive model used. Figure (6) shows the flow chart proposed in which the information generated from the verification of a given behavior required the use of the part are worked. To achieve the desired use behavior the part should perform functions or a functional structure by performing a phenomena sequence of the physical, chemical and/or biological effects. Such effects require that the part resists the mechanical stress (dynamic and/or static) why have to go to perform the functional structure. This analysis allows the designer to organize information about their intentions, and can thus describe the part functional structure of the light effects and stresses that occur in it. However, this analysis can be done by considering some preliminary design principles (*Pd's*) before the part function description and then solid geometric form final definition (solid features) should have to part physical characterization. Thus, it can involve the preliminary design principles to terminology used in its functional structure describing, will reach preliminary design principles, appropriate to the functional structure required realization. The structure shown in Fig. (6) is worked in the direction of the correlations between preliminary design principles (*Pd's*), functional description and solid geometry form. The goal is to reorganize the information that is related to the preliminary design stage and to define ways to achieve the scale itself to the part from the physical, chemical and biological effect verification that occur in their use behavior, that is, the attainment their functions. The use behavior analysis to define the stresses occurred in part functions perform, as well as numerous other essential factors to their final physical definition. To organize the design intentions on the analysis of what part design solution principles were considered the dynamics/statics stresses instead of preliminary design principles, as described to follow:

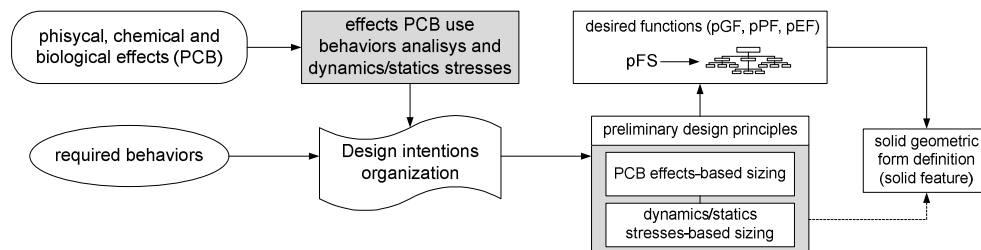

**Figure 6. Flow of information worked in the preliminary design stage.**

(1) **Statics stresses:** force (or moment) stationary applied to a member, unchanging in magnitude, application point and direction. A static stress can produce a traction or compression axial loading, a shear load, bending load, torsional load or any combination thereof. In this context come the mechanical strength, stiffness and the static fracture study. The mechanical strength as the property established prior to use (material, surface finish, solid geometry) and stiffness as material property undergo stress without deforming considerably, it being understood "stress" as body state property under a internal or external load/request;

(2) **Dynamics stresses:** force (or moment) applied to a member that produces variables stresses, repeated, alternating or fluctuating. A dynamics stresses can produce nucleation and broken that evolving to failure of the part. In this context come the natural frequencies study and the dynamics fatigue and fracture study. Here, it is also the bodies' kinematics study in the displacements, velocities and accelerations presence is a determinant factor of the function and form. Thus, a permissible load is required to be calculated, meaning "permissible load" as the loss of function load divided by a design factor calculated or specified.

From strength and dynamics/statics analysis is possible can make decisions about the material and its processing, manufacturing, and geometry, aiming to meet the functionality, security, competitiveness, reliability, usability, manufacturability, maintainability requirements, and others associated with the product. The preliminary design principles (*Pd's*) described in Tab. (6) are associated with term classes used in part function describes and impact on subsequent analysis to perform conventional mechanical systems. Based on their design meanings, leading to the solid geometry definition from the functional descriptions associated. It means that the words with design mean may be related to the preliminary design principles so that when a given design principles set is used for use behavior preliminary analysis it will, most likely a terms group more appropriate to description of a given function. The preliminary design principles work as drivers in the functional descriptions directing the designer to most likely group of functional descriptions that will lead to geometric configurations to better carry out the part functional structure. The use behavior analysis is closely related to the preliminary design principles and part function implementation. However, other factors are important for part final geometry definition. Usually some specific design requirements are needed to parts when we observe their life cycle phases in particular.

**Table 6. Correlation between the terminology to functional description and preliminary design principles.**

<i>(Pd's)</i>	term classes <sup>(2)</sup>		
	verbs <sup>(*)</sup>	nouns <sup>(*)</sup>	qualifiers <sup>(*)</sup>
<b>dynamic loading</b>	forward, rotate, urn, witch, rub, rubbing, slide, receive, balance, absorb, speed, generate, trigger, engage, admit,	torque, power, speed, spindle, spline, piston, cylinder, rod,	longitudinal, axial, radial, empty, full, alternately,
<b>static loading</b>	support, staying, becoming, absorb, accommodating, engaging, join, align, cushion, store, spread, block,	beam structure, screw, rivet, weld, plate, angle iron,	radial, inclined, statically, tension, bending, torsion,
<b>mechanical strength</b>	lock, rub, hold, absorb, dissolve, resist, structure, arrange, perform,	beam structure, screw, rivet, weld, brace, piston, cylinder,	longitudinal, axial, radial, internal, external,
<b>ridigity</b>	resist, sustain, support, retain, absorb, bend, twist, tension, shock, impact, load, deflect, pinching, pulling,	block, rod, tube, ring,	heavy, dense, hollow, solid, elastic,
<b>kinematic</b>	rotate, toggle, slide, balance, absorb, speed, fire, engage, expand, increase, pump, reverse, move, usually sucks,	block, tube, structure, base, body, device, plate, vehicle,	ongitudinal, axial, axially, radially, alternately,

These are identified here as preliminary design requirements (*PDR's*) and also can help find the best solid geometric when considered together with the preliminary design principles (*Pd's*). The preliminary design requirements are more related with part life cycle, from manufacturing to disposal, but are also present in the part static/dynamic simulation analysis for subsequent physical configuration and solid geometric modeling. Table (7) shows the main design requirements associated with the part life cycle, dynamic simulation analysis and its physical configuration.

**Table 7. Preliminary design requirements associated with the part life cycle, part loading analysis and geometry.**

associativity	preliminary design requirement ( <i>PRp's</i> )
<i>PRp's</i> associates with the part lyfe cycle ( <i>pLC</i> )	<b>Manufacturing (MA):</b> special equipment, supports,
	<b>Assembly (AS):</b> limitations, tolerances, surface finish,
	<b>Use (US):</b> operating conditions, ergonomics,
	<b>Mantenability (MN):</b> easy access, fittings, fixtures,
	<b>Disposal (DI):</b> as will be recycled,
<i>PRp's</i> associates with the finit element analysis ( <i>pFE</i> )	<b>Transport (TP):</b> packaging, suports,
	<b>Failure Identification (FI):</b> analysis methods ( <i>FMEA-failure mode and effect analysis</i> ), reliability,
<i>PRp's</i> associates with physical configuration and solid geometric modeling ( <i>pPM</i> )	<b>Form Optimization (FO):</b> analysis methods, best form, smaller dimensions, more effort,
	<b>Materials (MT):</b> corrosion resistance, creep behavior, bill of materials specifications of raw and auxiliary materials;
	<b>Physical Arrangement (PA):</b> flow direction, movement and position;
	<b>Sizing (SZ):</b> power, flow, interfaces sizes;

### 3.4 – Technical terminology and solid features description structure representation models

The correlation between the descriptive structures now is based on two additional models also hierarchical, representing the technical terminology fields and the corresponding system CAD solid features or geometry as shown in Figs. (7), (8) and (9). In the technical terminology representative model the same hierarchy is maintained, since we

<sup>(2)</sup>A more complete verb list, nouns and qualifiers to describe technical systems functional design, can be found in Linhares (2005).

understood that this correlation is significant and lends support to the research proposal. Here, names incorporate three hierarchical levels: specific terminology to identify parts on a global level (*GTT*), specific terminology to identify functional regions in the partial level (*PTT*) and specific terminology to identify the part physical details in the elementary level (*ETT*). Thus, the part, their physical regions and the corresponding details are given names characteristic, or technical terms that make up a standard terminology adjusted to the respective application fields of. In the geometries and features solid representative model, shown in Fig. (8), we explore the geometries sequence made in the CAD system from the operations performed by designer, here represented in three levels: Global features (*Gfeat*), Partial features (*Pfeat*) and Elementary features (*Efeat*). Normally, through a operations sequence on the desktop CAD systems, comes with a three-dimensional geometric model of the desired part. Of course, it depends on how each designer tends to run the part modeling in their specific application domain.

Figure (9) shows the general representation of the new model appearing in the four descriptive structures used individually represented in Figs. (2), (7) and (8). On its basis, can be accomplished a set computational implementation in search of repetition patterns. These new repetition patterns can identify inheritance instances and hierarchies between the descriptive compositions elements of the four structures presented in a systematic way better than the model previously proposed in Linhares (2005). In this figure, the representation alone on the left contains the initial idea that relates the two main correlation areas, the function space and the geometries space. The black dots from the higher balloon represent specific functions that can be performed by specific geometries of the flask bottom and vice versa.

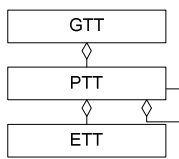

Figure 7. UML representation of the three level of technical terminology.

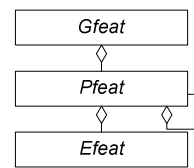

Figure 8. UML representation of the part solid features levels.

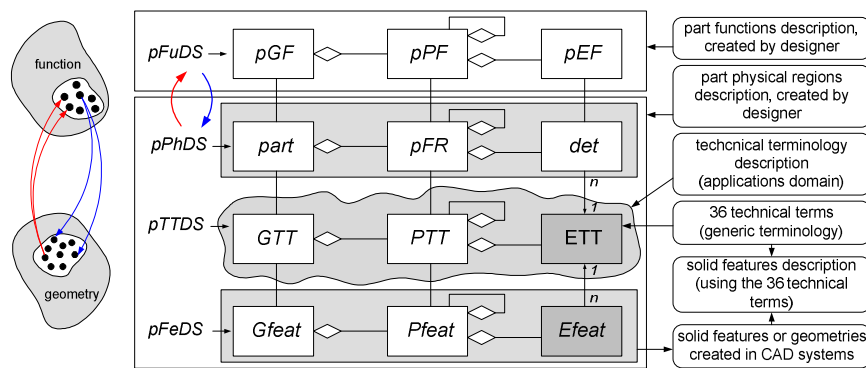

Figure 9. UML representation of the relations proposed by computer implementation new model.

In the central portion of Fig. (9), the top frame represents part functional descriptions space or part functions description structure (*pFDS*) created by designer with the help of the preliminary design principles (*Pd's*) and preliminary design requirements (*PDP's*). In the flask larger picture are represented three distinct spaces: above, of the part physical entities, functional region and detail or part physical descriptive structure (*pPDS*). In the center, of the global, partial and elementary terminology entities or part technical terminology descriptive structure (*pTDS*) and below the global, partial and elementary solid geometric entities or part features descriptive structure (*pFDS*). Still, in this framework, the terminology central representation in the cloud form is still shown as undefined since is used only elementary technical terminology (*ETT*) in model implementing. The relationship between the elementary technical terminology and physical elementary and solid features is represented by the arrows next to which appear represented the relationships types (*n:1*). The technical terminology used in the elementary level (*ETT*) is the proposal in Linhares (2005) reproduced here in Table 8 to describe basic features. The terminology presented in Tab. (8) is generic but signals a initial pattern after the computational realization that lead to repetition patterns. The Technical Terms proposed are used in the elementary features identification (*Efeat*). They may be dependent or independent of an initial profile (sketch) before the solid geometry creation. The "X" symbol that appears in the "profile" column indicates the terms whose geometric representation depends on this characteristic. Each of the 36 (thirty six) technical terms proposed here is defined from three viewpoints: conceptual, geometric and naming, in Linhares (2005).

#### 4. THE PRODUCT ANALYSIS

This research is based on the specific product geometric and functional requirements study. The content of the exhibits here refers to the motor vehicle design designed for off-road competitions organized by SAE Brazil annually,



the competition SAE Baja. The availability of information on the design of the vehicle and the team of student designers were contracted directly with the direction of education and coordination of the engineering program of the Instituto Superior Tupy (IST) of the Educational Society of Santa Catarina (Sociesc). Mechanical systems that make up the vehicle in question form the basis of the description of the models for descriptive representation. The systems that make the vehicle studied (minibaja TR-02), its nomenclature used by the design team and vehicle manufacturing and the part total number (in units), are described in Tab. (9).

**Table 8. Proposal technical terms list used to identify the solid features details in CAD systems.**

n°	technical terms	profile	n°	technical terms	profile
01	cylindrical trough hole		19	conical rebound	
02	cylindrical blind hole		20	prismatic groove	X
03	not cylindrical hole	X	21	helical groove	X
04	internal rotationed chanfer		22	prismatic rip	X
05	external rotationed chanfer		23	helical rip	X
06	internal prismatic chanfer		24	cylindrical body	
07	external prismatic chanfer		25	trough cylindrical body	
08	internal rotationed round		26	conical body	
09	external rotationed round		27	trough conical body	
10	internal prismatic round		28	prismática body	
11	external prismatic round		29	spherical body	
12	radial rotationed chuckhole	X	30	spherical cap	
13	axial rotationed chuckhole	X	31	elliptical cap	X
14	prismatic chuckhole	X	32	thread	X
15	conical chuckhole		33	cog	X
16	radial rotationed rebound	X	34	spherical chuckhole	
17	axial rotationed rebound	X	35	helical body	X
18	prismatic rebound	X	36	free surface	X

A part classification by for external global form (rotational, prismatic or mixing) and by mechanical system is shown in Tab. (10) where the relative numbers to the part total amounts for system and the units number by part type can be observed. The units subdivision (amount) and part types is important to understand later, in the research second phase, the statistics of the repetition standards occurrences, that is, the descriptive structures phrasal composition elements in relation to the terms technician used in the solid features identification created in system CAD.

**Table 9. Mechanical systems description TR-02 Baja vehicle.**

MS code	Mechanical System (MS)	Units number
01	chassis	101
02	direction	25
03	transmission	11
04	front suspension	86
05	back suspension	12
<b>Total</b>		<b>235</b>

**Table 10. Mechanical systems description that make TR-02 Baja vehicle and parts subdivision.**

N°	Mechanical systems	prismatic		rotational		mixing		total	
		un.	type	un.	type	un.	type	un.	type
01	chassis	32	14	1	1	68	42	101	57
02	direction	4	3	17	8	4	1	25	12
03	transmission	1	1	5	5	5	5	11	11
04	front suspension	6	3	42	8	38	7	86	18
05	back suspension	2	2	9	6	1	1	12	9
<b>Total</b>		<b>45</b>	<b>23</b>	<b>74</b>	<b>28</b>	<b>116</b>	<b>56</b>	<b>235</b>	<b>107</b>

Thus, this research phase was carried through having for platform the knowledge acquired about functions and part correspondent geometries that compose this product technician subsystems and systems. The vehicle descriptive structures description composition according considered model was created in set with the engineering academics team that acts in the vehicle Baja design and manufacturing. We search to identify which phrasal structures types co-ordinate the systems CAD geometries definitions, here calls "solid features", used in the part solid geometric modeling. The terminologies verification used in the solid physical structures identification, of the names that are assigned for parts normally, its functional regions and details, contributes for the design meanings study involved in the mechanical designer intentions and helps systematize the part functional design in the preliminary design phase.

## 5. Conclusions

This paper presented a model that allows to direct computational implementations to discover patterns repetition in function descriptive structures, physical regions, terminologies and solid geometries. The emphasis was to model a system of descriptive structures based in functions, physical regions, technical terminologies and solid features. To build this system was used a Baja competition off-road vehicle, modeled in systems CAD, whose feature were used in this paper description. This vehicle belongs the Superior Institute Tupy of the Educational Society of Santa Catarina hosted in the city of Joinville - SC. Later, in the research second phase, the descriptive structures computational

processing mentioned will emphasize relations between descriptions and geometries involved that presented a possible way for the solid geometries automatic search. This will have to pass for the repetition standards establishment for this mechanical design domain.

In the research initial phase we organize the knowledge base on the descriptive structures and the accomplishment of four descriptions: (a) Part functional structures description of the mechanical systems that integrate the vehicle (*pFuDS*); (b) Part physical structure names identification (*pPhDS*); (c) Technical terminology descriptive structure identification (*pTTDS*); (d) Part solid features descriptive structure identification (*pFeDS*), that is, of the solid geometric models and the guiding to be able to modeling the necessary computational processing. It was still organized, the knowledge about preliminary design principles (*Pd's*) and part design requirements (*PRP's*) that they can assist in the of the descriptive structures descriptions composition. Also, the computational applicatory development to work the mentioned descriptive structures was made. In the second phase the computational implementations and verification repetition standards will be carried through. From the computational implementation will be generated the reports with the occurrences graphical representations according adopted criteria, that will allow to visualize the areas from which the repetition standards could be found looked. The elements occurrences will be registered with sights to a study carried through from the statistical methods application whose objective is to lead to the mentioned repetition standards verification. For such the following verification criteria will have to be adopted: (a) “*vk*” (verbs), “*sk*” (substantive) and “*qk*” (qualifying) elements number occurrences in the descriptive structures compositions “*i*” for hierarchic level “*j*”; (b) Regularity of the descriptive structures descriptions occurrences “*i*” for each technical system, and, (c) Solid features occurrence number identified from the 36 (thirty six) standards technical terms that compose the technical terminology proposal in Tab. (8) and that they identify solids geometric features.

Although partial, the reached results lead to the conclusion that looked repetition standards are important to arrive it the automatic mapping between the functional and geometric spaces. It is known that the part final geometry creation depends on the mechanical designer design intentions. These, in turn, depend on the knowledge about involved variable in the product design as a whole, but specifically, of the each part requirements and preliminary design principles. Thus, the part final geometries definition passes for a previous organization of the tacit knowledge and goes for a taking of decisions constant process concerning the information correct guiding on the part adequate behavior in the assembly. Probably the behavior in use analysis is one of the most important factors to describe the part functions because it considers the part in use, in the work regimen that in the truth will be playing its function. Therefore, this research second phase goes to focus these aspects after the descriptive structures computational implementation.

## 6. References

- Back, N. et al., Projeto integrado de produtos: planejamento, concepção e modelagem. Ed. Manole, São Paulo, 2008;
- Bertziss, A. T., Natural-language-based development of information systems, *Data & Knowledge Engineering*, Vol 23, 1997;
- Blanchard, B.S. & Fabrycky, W. J., *Systems Engineering and Analysis*, Prentice-Hal, 1990;
- Bouzeghoub, M., Natural language for data bases, *Data & Knowledge Engineering*, Vol 21, pp. 109-110, 1997;
- Case, K. & Hounsell, M.S., Feature modelling: a validation methodology and its evaluation, *Journal of Materials Processing Technology* 4655, 1-9, 2000;
- Deng, P. -S. & Tsacle, E. G., Coupling genetic algorithms and rule-based systems for complex decisions, *Expert Systems with Applications*, Vol. 19, pp. 209-218, 2000;
- Hubka, V. & Eder, W. E., *Theory Technical Systems, A Total Concept Theory for Engineering Design*, Springer, New York, 1988;
- Hundal, M.S. and Byrne, J.F., Computer-assisted generation of function block diagrams in a methodical design procedure, New York, ASME, pp 252-258, 1988;
- Hundal, M.S., A systematic method for developing function structures, solution and concept variants, *Mechanisms and Machines Theory*, Vol 25, N0 3, pp 243-256, 1990;
- Hundal, M.S., A methodical procedure for search of solutions from function structures, *ICED'91 proceedings*, pp 9-16, 1991;
- Linhares, J. C. e DIAS, A., A new approach to integrated mechanical part design, *Proceedings of the Flexible Automation & Intelligent Manufacturing - FAIM'01*, Dublin, Irlanda, 2001(a);
- Linhares, J. C. e DIAS, A., Integrated computational interface in preliminary design applied to mechanical part design, *Proceedings of the International CIRP Design Seminar - CIRP'01*, pp. 283-288, Estocolmo, Suécia, 2001(b);
- Linhares, J. C. DIAS, A. Part Design: Functional and geometric Modeling Domain Relationship, *Proceedings of FAIM'03- Flexible Automation & Intelligent Manufacturing - FAIM'2003*, p. 519-529, Tampa, Flórida, 2003(a);
- Linhares, J. C. DIAS, A., Functional and geometric modeling domain relationship to part design. In: *Proceedings of CIRP'03 – 17th International Conference on Production Research*, Blacksburg, Virginia, 2003(b);
- Linhares, J. C. Uma Abordagem Computacional Baseada na Descrição de Funções de Peças para Projeto Preliminar de Produto. Tese de doutorado em engenharia mecânica, Universidade Federal de Santa Catarina, Florianópolis, 2005;
- Pahl, G. & Beitz, W., *Engineering Design – A systematic approach*, Springer Verlag, Berlin, 1988;
- Pahl, G. & Beitz, W., *Engineering Design – A systematic approach*, Springer Verlag, New York, 1996;
- Pahl, G. et al., *Projeto na engenharia: fundamentos do desenvolvimento eficaz de produtos – métodos e aplicações*, 6ª edição, Edgard Blücher, São Paulo, 2005;
- RodenackerR, W.G., *Methodisches Konstruieren*, Spring Verlag Berlin, New York, 1984;
- Roth, K., *Konstruieren mit Konstruktionskatalogen*, Spring Verlag, Berlin, New York, 1985;
- Roy, U. et al., Function-to-form mapping: model, representation and applications in design synthesis, *Computer-Aided Design* 33, pp. 699-719, Elsevier, 2001.