

DEVELOPMENT OF A TESTBED FOR HYBRID NETWORKED CONTROL SYSTEMS

Eduardo Paciência Godoy, egodoy@sorocaba.unesp.br

Thiago de Almeida Oliveira, thiago3008@gmail.com

Ivando Severino Diniz, ivando@sorocaba.unesp.br

GASI – Group of Automation and Integrated Systems, UNESP - Univ Estadual Paulista
Av. Três de março 511, CEP 18087-180, Sorocaba, São Paulo, Brazil

Arthur José Vieira Porto, ajvporto@sc.usp.br

Department of Mechanical Engineering, São Carlos School of Engineering - EESC, University of São Paulo - USP
Avenida Trabalhador São carlense, 400 CEP 13566-590, São Carlos, São Paulo, Brazil

Abstract. Networked control system (NCS) is a distributed control system in which sensors, actuators and controllers are physically separated and connected through in industrial communication network. Recent advances in wireless sensor networking technology have led to the development of low cost, low power, multifunctional sensor nodes. With these advances, a new tendency in using wireless networks in NCS has emerged. These systems are known as Wireless Networked Control Systems (WNCSs). The challenge in the development of WNCSs is to overcome the effects of the nonlinearities and restrictions imposed by the communication network on the closed loop that impact its performance and stability. Among these effects are mainly the packet losses, the variable network delays and the communication constraints caused by limited bandwidth and network sharing with other devices. Aiming to highlight the major concepts and to verify theoretical results in the area of WNCS, a testbed with CAN and ZigBee networks was developed. The architecture proposed for the testbed is highly flexible allowing experiments to be conducted for several testbed configurations, with different design parameters and controller algorithms. This paper describes the design and implementation of this testbed focusing on the discussion of hardware and software implementations and presenting the opportunities and benefits of its use to WNCSs. Experiments done with the testbed confirm its functionality and effectiveness for WNCSs applications.

Keywords: networked control system, education, wireless sensor, industrial network

1. INTRODUCTION

Recent applications of fieldbus based control systems demonstrate a new approach for the use of industrial networks (Sauter, 2011). In this type of application, named Networked Control Systems (NCS), the controller, the sensor and the plant are physically separated and connected through a communication network (Gupta and Chow, 2010) as shown in Fig. 1. The control signal is sent to the controller by a message transmitted over the network while the sensor samples the plant output and returns the data to the controller also transmitting a message over the network.

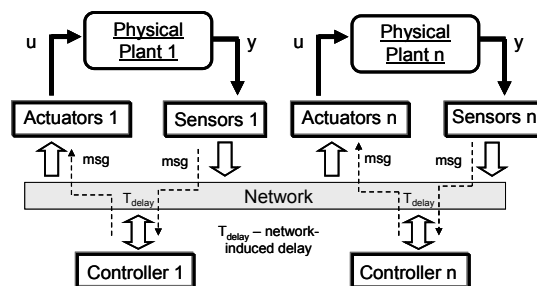

Figure 1. Structure of a NCS

Networked control systems impose additional problems inherent in control applications that are usually difficult to meet due to the variations and uncertainties introduced by the communication network: delays, jitter, bandwidth limitations and packet losses (Baillieul and Antsaklis, 2007). A consensus in the research on NCS is that the presence of these imperfections and restrictions relating to the communication network can significantly affect the performance of the control loop, and could even make it unstable, as demonstrated in Cloosterman et al. (2009). Therefore, the main challenge in NCSs is to understand how these factors affect the performance and stability of the system, preferably quantitative way, and highlight the most important factors for each type of NCS (Heemels et al., 2010).

Within the context of communication networks, wireless sensor networks have been the subject of intensive research recently (Sauter et al., 2010). These wireless networks have the potential to revolutionize various segments of the economy and activities through applications ranging from environmental and agricultural monitoring, industrial process

control, transport, Smart grids and energy applications (Johansson, 2011). Wireless systems can be used also in places of difficult access. In environments with long distances between devices as in refineries or other process plants, the routing capability of the protocol allows the use of wireless devices without the need for repeaters.

With the recent advances in wireless sensor networking technology such as low cost, low power and multifunctional sensor nodes, a new trend has emerged in using wireless networks for control applications (Fischione et al., 2011) and for NCSs (Park et al., 2011). These systems are known as Wireless Networked Control System (WNCS). Many interesting characteristics inherent to wireless networks are motivating the development of WNCSs (Johansson, 2011). For fieldbus control systems, there is always the risk of cutting the bus that connects all the devices. NCSs using wireless networks can eliminate all the problems arising from wires in the system. This is the most important advantage of using such technology. WNCSs enable interoperability between existing wired and wireless systems and also provide advantages in power and flexibility when compared to wired ones (Naghshabrizi and Hespanha, 2011).

Because of the growing importance of the distributed control and communication networks fields in the formation of engineers, the universities have started to develop laboratories equipped with specific testbed focused on the learning and education of these subjects (Franz, 2003 and Luntz et al., 2006). And this interest can be justified because the experiments covered by these laboratories allow students to integrate the concepts and theoretical knowledge acquired during various courses (Hristu-Varsakelis and Levine, 2005). However, as several examples of laboratories related to distributed control with fieldbus that can easily be found, the existence of these laboratories for NCS is not common (Godoy et al., 2010), mainly the ones focusing on WNCS.

Based on the latter fact, this paper describes the development of a hybrid NCS testbed using a wired CAN and a wireless ZigBee network. The objective of the testbed is to facilitate the education in the area of WNCS through the implementation of experiments to verify theoretical concepts.

2. TESTBED FOR EDUCATION IN INDUSTRIAL NETWORKS AND NCS

Laboratory courses are well recognized for their educational value in engineering formation. Using laboratories for industrial networks education supplies an effective way to provide students with knowledge on recent technologies and equipment used in the industrial area (Hristu-Varsakelis and Levine, 2005). When one looks for commercial products to build these platforms and to equip laboratories for fieldbus and networked control experiments, one can easily find training equipment and pilot plants provided by several automation companies. However, in agreement to Martin and Tadeo (2006), these commercial equipment used exclusively for educational purposes present several drawbacks such as high cost, the fact that all components are from one single manufacturer which harms the concept of interoperability between different products from different manufacturers, and the fact that these equipment represent closed solutions which in most of the times do not allow modification of codes and algorithms, therefore requiring proprietary tools.

In order to overcome these problems and limitations, many works from universities have been developing their own platforms and laboratories for fieldbus research and teaching, consisting mainly on hardware and software built-in home solutions (Luntz et al., 2006). A laboratory focusing on Profibus learning using industrial PLC, the Matlab/Simulink environment and a three tank level didactic plant is presented in Voglauer et al. (2005). Another platform that also uses PLC based industrial solutions and provides capabilities for learning and study of Profibus and Interbus technologies is detailed in Martin and Tadeo (2006). An advantage of this platform is that all the different parts of the equipment are accessible because it has been designed using an open and flexible architecture.

The low cost of the CAN protocol has widespread the use of this network in laboratories for educational purposes. Kolla (2007) presents the integration of several experiments related to CAN-based hardware and software tools in instrumentation and distributed control courses laboratories. Bucher and Balemi (2008) developed a platform using Linux RTAI (real-time version of the Linux operational system) for education on real-time evaluation and rapid control prototyping of CAN-based networks. An interesting result of this paper was the implementation of an interface library for many CAN capable devices with code generation capabilities for Matlab/Simulink/RTW (Real-Time Workshop).

Regardless of the availability of fieldbus platforms, for NCS, which is a different approach for the use of communication networks, these platforms are more recent. Current examples are the works of Kaufmann et al. (2008) and Gao et al., (2011), which respectively present a laboratory for teaching NCS applied to control a robot arm with industrial CAN and Ethernet network technologies, and a platform for experiments of scheduling, sampling and jitter in a NCS using CAN and Switched-Ethernet networks. The last advance in these platforms and laboratories is the inclusion of wireless networks in control loops. Bemporad et al. (2010) presents a hybrid (discrete and continuous) dynamical laboratory process controlled with wireless networks. In this paper a predictive control is designed in which a WLAN network is used to transmit the control signals and a ZigBee network is used for the sensor measurements. A testbed for evaluating the application of WNCS in radio-harsh environments is presented in Taylor and Slipp (2010). One interesting proposal of this paper is to provide support for tests with industrial wireless networks such as ISA100.11a and WirelessHART.

3. TESTBED FOR HYBRID NETWORKED CONTROL SYSTEM

3.1. Architecture

The testbed presented in this paper was developed by the São Paulo State University, in Brazil, for WNCS study and is composed by a DC motor (velocity and position) control module and a didactic plant of process control. The didactic plant is provided by Festo Didactic (Festo Compact Workstation) with four industrial controlled variables: temperature, flow, pressure and level. The communication networks used for the control systems integration are the CAN protocol for transmission of the control signals and the ZigBee wireless network for the transmission of the sensor measurements.

The architecture of the WNCS testbed is shown in Fig. 2. Each one of the control systems are assembled in a WNCS configuration over the CAN and ZigBee networks. A description of these control systems is presented below.

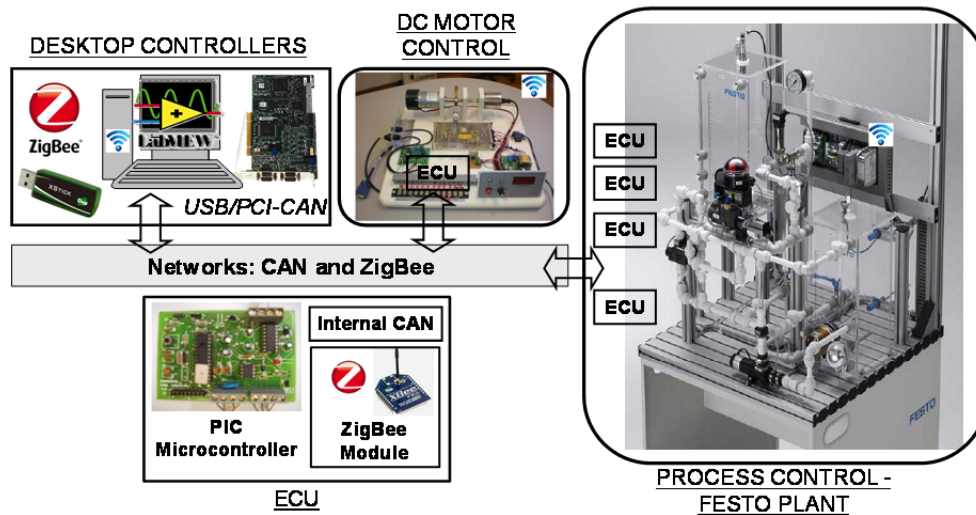

Figure 2. Schematic of the WNCS Testbed with CAN and ZigBee

The DC motor module is used for velocity and position control and is composed of a DC motor, an incremental encoder for measurement, a PWM drive, an electronic circuit for the encoder read and a disc for application of different loads in the motor shaft. The objective of this NCS is the experimentation on velocity and position control according to a user defined reference and under different loads applied to the system.

The Festo didactic plant is provided with four controller closed loops for local control design with a PLC. For the purpose of this paper, network communication capabilities were added. The plant has basically four sensors (flow, level, temperature and pressure) and three actuators (electric water pump, proportional valve and heater). The input (sensor measurements) and output (control) signals are industry standard based on 0-10VDC. The four controller systems can each be operated individually. Using a corresponding controller, the two controlled systems (ex: level and flow rate) can be set up as a cascade control system.

The didactic plant is also composed by two water tanks, PVC piping connecting the two tanks, a reservoir in which the entrance of water changes the air pressure and analog controlled drives to trigger the actuators. It is important to clarify that the pressure, level and flow variables can be changed by controlling the electric water pump or by keeping the water pump turned on and controlling the proportional valve.

3.2. Communication Networks

The CAN protocol has been developed to interconnect ECUs in automotive area, but recently it has also been applied in many other networked applications. As described by Johansson et al. (2005), in CAN-based networks data are transmitted and received using messages that carry data from a transmitting node to one or more receiving nodes. An identifier, unique throughout the network, labels each message and its value defines the priority of the message to access the network. The CAN protocol is optimized for short messages and uses a CSMA/CD with NDBA (Carrier Sense Multiple Access / Collision Detection with Non Destructive Bitwise Arbitration) arbitration access method. The bit stream of a transmission is synchronized on the start bit, and the arbitration is performed on the following message identifier, in which a logic zero is dominant over a logic one.

The IEEE 802.15.4 standard defines the protocol and interconnection of devices via radio communication in a low data rate, low power consumption, and low cost personal area network (PAN). ZigBee builds upon the IEEE 802.15.4 standard which defines the physical and data layers (Baronti et al., 2007). ZigBee standardizes the higher layers of the protocol stack. The network layer is in charge of organizing and providing routing over a multi hop network (built on top of the IEEE 802.15.4 functionalities), while the Application Layer intends to provide a framework for distributed

application development and communication. ZigBee network layer defines three device types: End device (simple device), Router (routing capabilities device) and Coordinator (managing device).

The physical layer provides an interface between the MAC sub layer and the physical radio channel. It usually defines a frequency bands of 2,4Ghz (with 16 channels) using the Direct Sequence Spread Spectrum (DSSS) access mode with a data rate of 250Kbps. The data layer provides an interface between upper layers and the physical layer. It handles channel access, link management, frame validation, security, and nodes synchronization (Baronti et al., 2007). The MAC protocol supports two operational modes that may be selected by the coordinator: beacon enabled mode and non-beacon enabled mode. In the non-beacon enabled mode the MAC is provided by an unslotted CSMA/CA (Carrier Sense Multiple Access/ Collision Avoidance) mechanism. In the beacon enabled mode, the beacons are periodically sent by ZigBee coordinator to synchronize nodes that are associated with it, and to identify the PAN.

3.3. Hardware Implementation

A common architecture for WNCS includes a plant in which the sensor and the controller have a point to point wireless communication between them. It is easy to understand why to first migrate the sensor link to a wireless connection. As the actuator usually needs relative high power to drive the plant, sometimes it is not reasonable to implement a wireless connection to this link if the actuator will continue requiring a physical connection for power supply (pneumatic or electric) or even if the actuator lifetime will be deeply decreased in this situation (Paavola and Leiviska, 2010). Each of the defined control systems implemented in the WNCS testbed uses that schematic shown in Fig. 3.

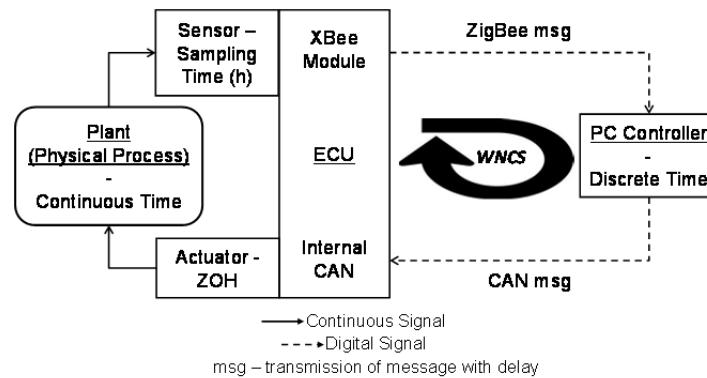

Figure 3. Block Diagram of the Hardware Implementation of the WNCS

A PIC18F2580 microcontroller based electronic control unit (ECU) is responsible for the data acquisition (sensor), actuation in the plant (actuator) and communication with the CAN-based network (using the internal CAN controller). This ECU is also responsible for the sensor data acquisition and transmission of the information in the ZigBee network using an XBee module from Digi International. Therefore, the sensor and actuator of the WNCS are physically placed together. The WNCS controller is physically separated from the plant and implemented using a desktop PC computer. This controller uses LabVIEW and PCI-CAN interface from National Instruments providing support for the development of the control strategies. So, one controller can be the responsible for controlling all WNCS of the testbed.

According to Fig. 3, the WNCS implementation was done using models based on continuous and discrete time. Each process to be controlled or plant in the WNCS testbed is admitted to be continuous time, and thus the actuator implements zero-order hold (ZOH) holding the last control signal until the next one arrives or until the next sampling time. The time-driven sensor node samples the plant periodically and sends the information to the controller node over the ZigBee network, providing the discretization of the system. Upon receiving a sample, the controller computes a control signal which is sent through the CAN network to the actuator node, where it is subsequently actuated. The threads executing in the controller and actuator nodes are both event-driven, which means that their actions are performed as soon as they receive messages. Also the exchange of messages (msg) between the sensor, actuator and controller induces network delays in the WNCS.

Considering the ZigBee network, in the WNCS testbed the controller is configured as Coordinator and each sensor as a Router or End Device, with point to point communication (no hops on the message transmission) with the coordinator. It provides a multicast transmission or the capability of one controller to receive (and control) information from more than one sensor. The time-driven sensor node samples the plant periodically and sends the information to the controller node over the ZigBee network, providing the discretization of the system. Upon receiving a sample, the controller computes a control signal which is sent through the CAN network to the actuator node, where it is subsequently actuated. The threads executing in the controller and actuator nodes are both event-driven, which means

that their actions are performed as soon as they receive messages. Also the exchange of messages (msg) between the sensor, actuator and controller induces network delays in the WNCS.

3.4. Software Implementation

The software running on each ECU of the testbed is a simple compiled routine of periodically sampling and actuation triggered by the reception of a new control signal. The main development on software in this paper is on the WNCS controller, implementing a State Machine Design Pattern with Producer/Consumer. This technique facilitates the development of the code and provides a scalable and expandable controller for the WNCS testbed (Endsley et al., 2006). The state machine implemented has eight states (Initialization, SelectWNCS, Monitor, ReceiveMSG, DetermineWNCS, ComputeControl, SendMSG and Stop), each one with a specific function in the controller operation, as shown in the flowchart of the Fig. 4. The main function of each state is given below.

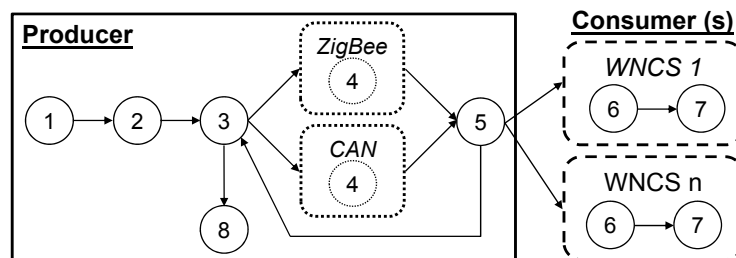

Figure. 4. Operation Flowchart for the Controller State Machine

1. Initialization: state responsible for the CAN and ZigBee configuration and initialization of the WNCS connected to the testbed;
2. SelectWNCS: state responsible for selecting which (and how many) WNCS of the testbed will be controlled by that controller;
3. Monitor: state responsible for monitoring the user interface and the CAN and ZigBee networks, indicating parameters change or available messages in the reception queues;
4. ReceiveMSG: state responsible for receiving and disassembling the CAN and ZigBee messages into the required information (identifier and data fields). This state has two options (CAN message or ZigBee message) depending on which kind of message that can be received;
5. DetermineWNCS: state responsible for identifying if the message received will be used to control some of the WNCS selected previously for that controller;
6. ComputeControl: state responsible for using the received sensor information and for calculating a new control signal, respectively to all WNCS connected in the testbed, by using control algorithms loaded or developed by the user;
7. SendMSG: state responsible for the transmission of the CAN messages, containing the control signal calculated, respectively to all WNCS connected in the testbed;
8. Stop: state responsible for finishing the operation of the desktop controller and for sending CAN messages to stop the operation of all WNCS of the testbed.

The concept of Producer/Consumer in Fig. 4 was used to enable a parallel processing for the case of multiple WNCS running on the same controller (PC). In this case, the producer repeat loop is responsible for creating the tasks to be executed in their respective consumers, representing each of the WNCS controllers connected to the platform. The tasks created by the producer are inserted into a queue and made available to the consumer(s). In the case of more than one consumer, the tasks are removed from the queue by each consumer and processed in parallel. This parallel processing of WNCS controllers represents a great advantage of the structure implemented, eliminating a known problem of the use of a simple state machine. This problem is related to the impossibility to treat more than one state simultaneously (in the case of the testbed: to calculate a new control signal to more than one WNCS).

It is important to note that the consumers in the software implementation only run if there is a specific task created for it previously by the producer. So that consumers, related the WNCS which are not configured for that controller (PC) will not share (or waste) processing capabilities of the controller.

The state machine developed for the WNCS controller provided a highly flexible configuration because it allows the reuse of code and replication of the controller software to other computers. In addition, this software configuration can be used in any other desktop controller in the testbed only by selecting which and how many WNCS will be controlled by that controller. In addition, the state machine have also assured an ease way to insert more WNCS in the testbed (just configuring the states 4 to 7 to deal with the added WNCS) and to test different control algorithms for the WNCS

controllers of the testbed (just adding the control algorithms designed to list that can be used by the ComputeControl state).

4. APPLICATION OF THE WNCS TESTBED

The purpose of the developed testbed is to help the study of WNCS, providing experimental results to verify theoretical concepts of this technology. The next subsections describe some application examples initially implemented in the WNCS testbed. In this paper, only results for the DC motor WNCS for velocity control was used to simplify the presentation. And for this WNCS operation, the following parameters were used: CAN speed of 250kbit/s, messages data length of two bytes for the ECU, sensor sampling interval (discretization time) of 100ms.

4.1. Impact of the Wireless Link in the Closed Loop

It's important to verify that the discrete time PID controller used in the experiments uses a discretization time of 100ms, which is equal to the sensor sampling interval. However as we are using the ZigBee device as the sensor link, the greater values of this device time delay and jitter are expected to impact (and increase) this fixed value of 100ms and consequently degrade the WNCS control performance.

The results of the closed loop WNCS for the motor velocity control is shown in Fig. 5. The idea of this graph is to compare the performance of the NCS only using CAN (previously) with the performance using ZigBee/CAN (or WNCS). To make this comparison the PID parameters were the same in both situations.

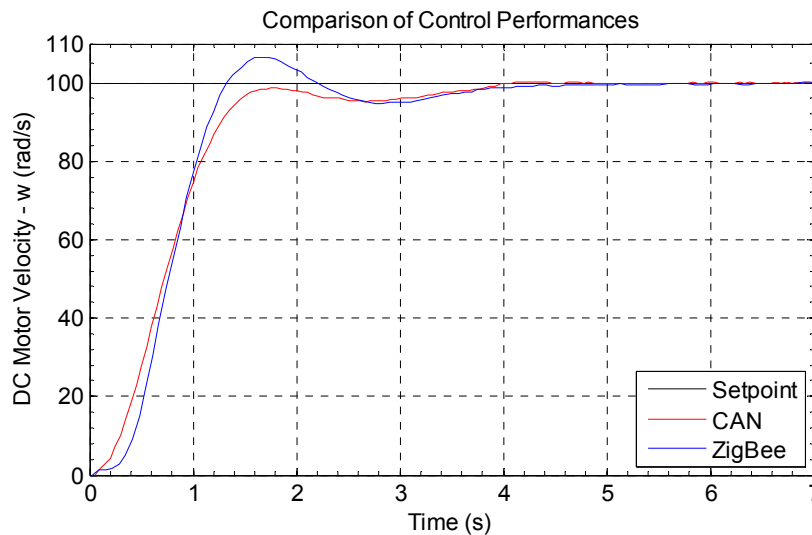

Figure. 5. Comparison of Control Performances between the CAN-based NCS and the ZigBee WNCS

The graph of Fig. 5 shows the comparison of the closed loop control performances between the implementation of the NCS using only the CAN network and with the ZigBee network in the sensor link. The large delays and jitter of using the ZigBee device as the network degrade the performance of the system. Comparing both graphs, an increase in the response time (related to the greater value of the delay in the ZigBee) can be seen as well as the output becomes a little more oscillatory.

4.2. Control Design Tests

According to Eriksson (2008), controllers for NCS cannot be designed with continuous time control theory because the resulting performance is unsatisfactory. The controllers for NCS have to handle the network delay effects in the systems and need to be designed in discrete time. Based on the flexibility and large application, a PID controller was designed for the systems in the WNCS testbed. The controller is a discrete-time PID controller derived with the backward derivative approximation with setpoint weighting, reference off, filtering on derivative part and Anti-Windup of the integrative part and its block diagram is shown in Fig. 6.

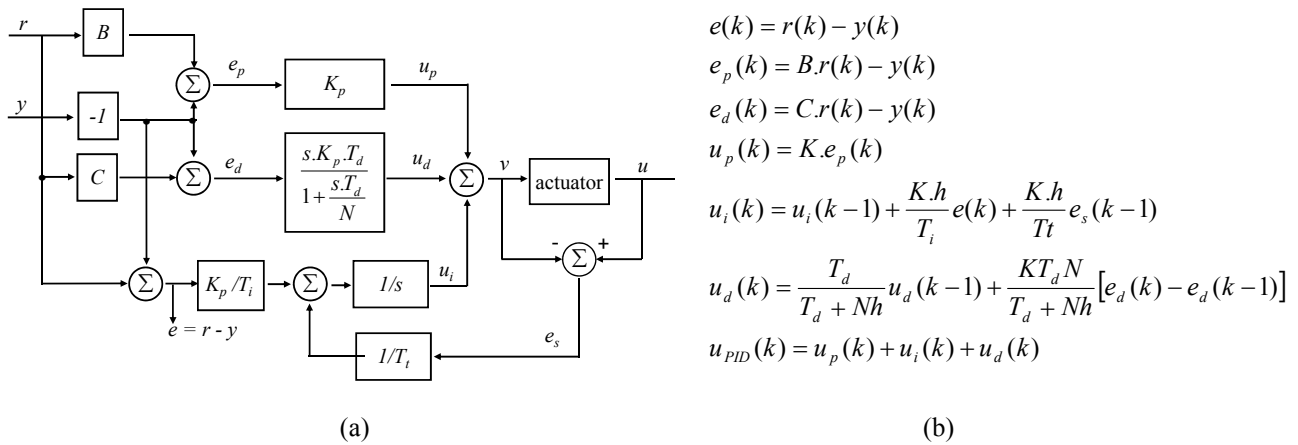

Figure 6. Discrete-Time PID Controller for WNCs: (a) Block Diagram (b) Routine for Parameters Implementation

The WNCs for DC motor velocity control was used to exemplify the control design tests done, comparing the WNCs results for a step response among the PID controller with Ziegler Nichols (ZN), Chien, Hrones e Reswick and manual tuning methods. The following parameters were used for the PID controllers: N=10 for the constant filtering, B=1 in the reference weighting constant and $T_t = T_i$ for PI controllers. The PID controller gains selected were: $K_p = 0.136$ and $T_i = 1.33$ for the ZN tuning, $K_p = 0.105$ and $T_i = 1$ for CHR and $K_p = 0.06$ and $T_i = 0.65$ for manual tuning.

Figure 7 presents the comparison among the results for different PID tuning methods selected for the DC motor velocity control WNCs.

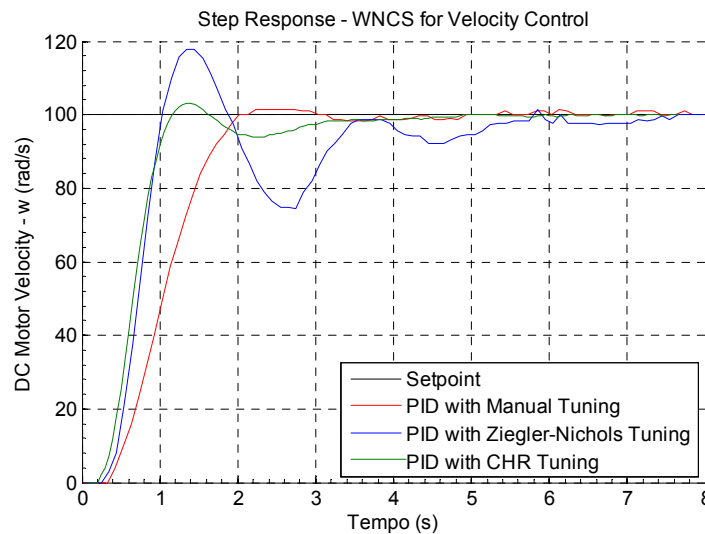

Figure 7. Comparison for PID Tuning Methods of the NCS for DC Motor Velocity Control

Analyzing the results, the CHR method can be selected for use in the WNCs. Fig. 8 presents the output results of the implemented WNCs for motor velocity control for a defined operation with different setpoints.

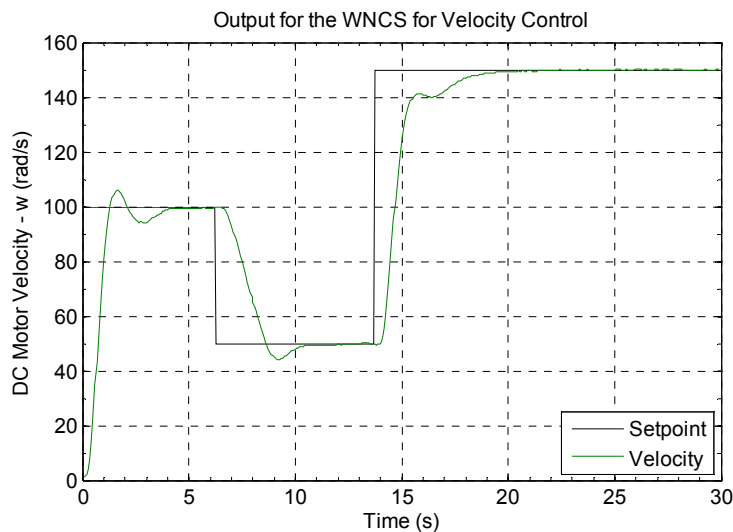

Figure 8. Control Performance of the WNCS for Velocity Control

4.3. Impact of Message Loss on the Wireless Network

A great difference between NCSs and digital control systems is the possibility of packet losses during the transmission of messages over the network. Usually, the packet loss is related to errors in the transmission of messages, overflow in the devices buffers and MAC errors (Hespanha et al., 2007). As a consequence of this inconsistency in the data transmission, the control performance and stability of WNCSs are directly degraded by the increase in the packet losses.

In order to verify this concept in WNCS, the graph of Fig. 9 compares the WNCS control performance between the ideal case (without message loss) and the three scenarios with messages lost in the wireless network. In this experiment, the loss of message was configured by programming the ECU do not send a specific amount of messages. It can be seen that the increase on the loss of sensor messages degraded the control performance of the WNCS, making it more oscillatory.

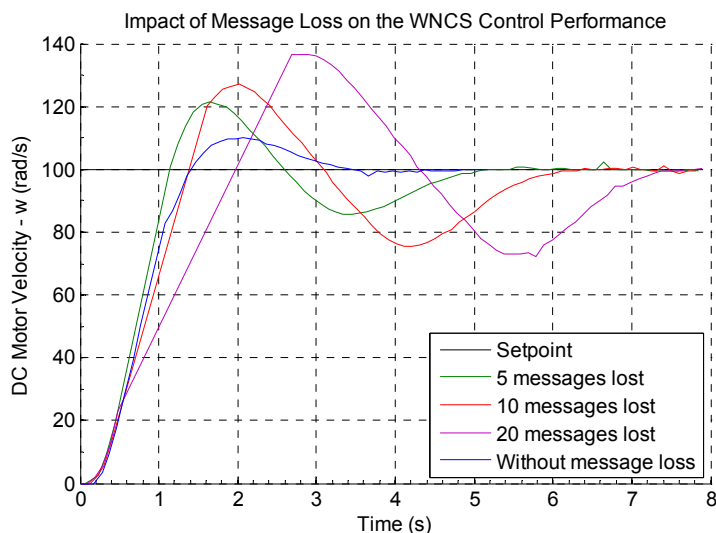

Figure 9. Comparison of Control Performances for the WNCS for Velocity Control with Message Loss

5. COMMENTS AND CONCLUSIONS

The main benefit of the testbed for students as well as for research is the possibility of providing knowledge (advantages, challenges and ways to implement) about the development of WNCS using CAN and ZigBee networks, highlighting the fundamental concepts of this technology. The utilization of the NCS testbed reveals other possible benefits related to the achievement of tasks such as analysis, modeling, control design and tests.

The architecture developed for the WNCS testbed provided high flexibility for the research and teaching of WNCS, allowing experiments to be conducted for different testbed configurations and design parameters. Regarding the hardware implementation, new WNCSs can be integrated in the developed architecture with minimum effort. The application of the state machine pattern in the software implementation facilitated code development and provided a scalable and expandable controller for the WNCS testbed. In addition, the implemented software becomes very useful because it can be used in any other desktop controller in the testbed and also it simplifies the tests of different control algorithms for the WNCSs of the testbed. The great advantage of the producer/consumer concept used in the software implementation was the support to parallel processing. With this approach, one WNCS controller can control in parallel different WNCS without having its performance compromised or the having the execution of tasks delayed.

The functionality and versatility of the WNCS testbed were verified through experiments for analyzing the impact of the wireless network on the closed loop control, testing of WNCS control designs and for evaluation of the effect on the WNCS control performance of message loss on the ZigBee network.

Future works are related to opportunities for the WNCS testbed. The authors want to extend the experiments of the testbed to cover more related issues of WNCS such as the impact of network delays and sampling interval. Also, a material focused on education such lesson guides is under construction to improve the of the WNCS testbed.

6. ACKNOWLEDGEMENTS

The authors acknowledge grant 2011/23217-0, São Paulo Research Foundation (FAPESP) for the support to this paper.

7. REFERENCES

- Baillieul, J. and Antsaklis, P.J., 2007, "Control and Communication Challenges in Networked Real Time Systems", *Proceedings of IEEE Technology of Networked Control Systems*, Vol. 95, N. 1, p. 09-28.
- Baronti, P., Pillai, P., Chook, V.W.C., Chessa, V., Gotta, V., Hu, Y.F. (2007). Wireless sensor networks: A survey on the state of the art and the 802.15.4 and ZigBee standards, *Computer Communications*, Vol. 30, N. 7, p. 1655-1695.
- Bemporad, A., Cairano, S., Henriksson, E., Johansson, K.H. 2010. Hybrid model predictive control based on wireless sensor feedback: An experimental study, *International Journal of Robust and Nonlinear Control*, Vol. 20, N. 2, p. 209–225, 25 January.
- Bucher, R. and Balemi, S. 2008. CAN-bus based rapid control prototyping system for education laboratories. In *Proceedings of the 17th IFAC World Congress*, p. 9671-9677, Seoul, Korea.
- Cloosterman, M. B. G.; Van De Wouw, N.; Heemels, W. P. M. H.; Nijmeijer, H. 2009. Stability of networked control systems with uncertain time-varying delays, *IEEE Transactions on Automatic Control*, Vol. 54, N. 7, p. 1575–1580, July.
- Endsley, E.W., Almeida, E.E. and Tilbury, D.M. 2006. Modular finite state machines: Development and application to reconfigurable manufacturing cell controller generation. *Control Engineering Practice*, Vol. 14, p.1127–1142.
- Eriksson, L., 2008, *PID Controller Design and Tuning in Networked Control Systems*, PhD Thesis, Dept. of Aut. and Systems Tech., Helsinki Univ. of Tech., Finland, 118p.
- Fischione, C.; Park, P.; Di Marco, P.; Johansson, K.H. 2011. *Design Principles of Wireless Sensor Networks Protocols for Control Applications*, S.K. Mazumder (ed.), Wireless Networking Based Control, Ch. 9, Springer, p. 203-238.
- Franz, H. 2003. Fieldbus Instrumentation Technology Development at Houston, Texas Area Universities and Colleges. In *Proceedings of ASEE Annual Conference, & Exposition*, Tennessee, USA.
- Gao, Z., Chen Q., Hu, W. 2011. A New Experimental Platform for Networked Control Systems based on CAN and Switched-Ethernet. *Information Technology Journal*, Vol. 01, p. 219-230.
- Godoy, E.P., Pereira, R.R.D., Scorzoni, F., Porto, A.J.V. and Inamasu, R.Y., 2010, "CAN-based Platform for the Study and Experimentation on Networked Control Systems (NCS)", In *Proceedings of the 5th IFAC Symposium on Mechatronics Systems*, Boston, USA.
- Gupta, R.A. and Chow, M.Y., 2010, Networked Control System: Overview and Research Trends, *IEEE Transactions on Industrial Electronics*, Vol. 57, N. 7, p. 2527-2535, July.
- Heemels, W.P.M.H., A.R. Teel, N. Van De Wouw And N. Dragan 2010. Networked Control Systems With Communication Constraints: Tradeoffs Between Transmission Intervals, Delays and Performance. *IEEE Transactions on Automatic Control*, Vol. 55, N. 8, p. 1781-1796.
- Hespanha, J.P., Nighshtabrizi, P. and XU, Y., 2007, A Survey of Recent Results in Networked Control Systems, *IEEE Proceedings of the Technology of Networked Control Systems*, Vol. 95, N. 1, p. 138-162.
- Hristu-Varsakelis, D., Levine, W.S. 2005. An undergraduate laboratory for networked digital control systems. *IEEE Control Systems Magazine*, Vol. 25, N. 1, p. 60 – 62.
- Johansson, K.H. 2011. Motivations, Challenges and Wireless for Control of Networked and large Scale Systems, In *Proceedings of the 4th HYCON PhD School on Control of Networked and Large Scale Systems*, June 21-24, Trento, Italy.

- Johansson, K.H., Torngrén, M. and Nielsen, L., 2005. Vehicle applications of controller area network, *Handbook of Networked and Embedded Control Systems*, Ed. Birkhäuser, 25p.
- Kaufmann, M., Schweiger, F. and Bretthauer, G. 2008. A Laboratory Platform for Project Based Training Concerning the Development of Complex Networked Control Systems. In *Proc. of the 17th IFAC World Congress*, p. 9785-9790, Seoul, Korea.
- Kolla, S. 2007. CAN-based Fieldbus Experiments. In *Proc. of the 2007 ASEE Annual Conference & Exposition*, Honolulu, Hawaii, USA.
- Luntz, J., Almeida, E.E., Tilbury, D.M., Moyne, J., Hargrove, K. (2006). The Distributed Reconfigurable Factory Testbed (DRFT): A collaborative cross-university manufacturing system testbed. In *Proceedings of the 2006 ASEE Annual Conference and Exposition*.
- Martin, J.V. and Tadeo, F. 2006. Learning fieldbus technology using open and flexible educational equipment. In *Proc. of the Seventh IFAC Symposium on Advances in Control Education*, Vol. 7, N. 1, Spain.
- Naghshabrizi, P.; Hespanha, J.P. 2011. *Implementation Considerations For Wireless Networked Control Systems*, S.K. Mazumder (ed.), *Wireless Networking Based Control*, Ch. 1, Springer, p. 1-27.
- Paavola, M., K. Leiviska 2010. *Wireless Sensor Networks in Industrial Automation*, J.S. Blanes (ed.), *Factory Automation*, Ch 10, InTech, p. 201-220.
- Park, P.; Araujo, J.; Johansson, K.H.; 2011. Wireless networked control system co-design, In *Proceedings of the 2011 IEEE International Conference on Networking, Sensing and Control (ICNSC)*, p.486-491, 11-13 April 2011.
- Sauter, T. 2010. The Three Generations of Field-Level Networks—Evolution and Compatibility Issues, *IEEE Transactions on Industrial Electronics*, Vol.57, N. 11, p.3585-3595, Nov.
- Sauter, T.; Soucek, S.; Kastner, W.; Dietrich, D. 2011. The Evolution of Factory and Building Automation, *IEEE Industrial Electronics Magazine*, Vol.5, N. 3, p.35-48, Sept.
- Taylor, J.H.; Slipp, J. 2010. An integrated testbed for advanced wireless networked control systems technology, In *Proceedings of the 36th Annual Conference on IEEE Industrial Electronics Society (IECON 2010)*, p.2101-2106, 7-10 Nov.
- Voglauer, B., Garcia, R. and Jorgl, H.P. 2005. Improvements of a three-tank-system operated in real time with MATLAB in a PLC-Profibus-network. In *Proc. of the 16th IFAC World Congress*, 16, pp. 43-48, Prague, Czech Republic.

9. RESPONSIBILITY NOTICE

The authors are the only responsible for the printed material included in this paper.