

INTELLIGENT ELEVATOR FOR ASSISTING MAINTENANCE OF DISTRIBUTION POWER LINE

William Scaff

Ivo da Paz Lopes

Victor Sverzuti

Renan Augusto Pavani

André Riyuiti Hirakawa

Oswaldo Horikawa

Escola Politécnica of São Paulo University, Av. Prof. Mello Moraes, 2231, 05508-900, São Paulo, SP, Brazil
victor.cpfl.pd@gmail.com, ivo.cpfl@gmail.com, williamscaff.usp@gmail.com, augusto.pavani@gmail.com, arhiraka@usp.br, ohorikaw@usp.br

Alexandre Chamas Filho

Antonio Palmiro Fujita

Ednilson José Menatti

Paulista Power and Light Co.- CPFL, Rod. Campinas Mogi-Mirim, km 2.5, 13088-900, Campinas, SP, Brazil
achamas@cpfl.com.br, afujita@cpfl.com.br, ednilson@cpfl.com.br

Abstract. *In urban power distribution lines, there is a concern about performing the maintenance services, emergencial or not, with efficiency, in the shortest time possible and with less disturbances around the work area, but still bearing in mind the safety and ergonomics of the electrician, as well as the operating costs. Part of this demand includes public lighting services, where maintenance consists on the replacement of the lamp or reactor, situated on the utility pole, respectively, at 9 and 7 meters above the ground. For this service, usually a truck with an aerial bucket or even a manual ladder is employed. Despite the aerial bucket truck being consolidated as a versatile device for various jobs across the electricity network, it stills presents disadvantages to the work described, such as when executed in an urban environment, as its high initial cost, large work area - hence occasionally impacting traffic - and the necessity of a licensed professional for driving heavy vehicles. The use of manual ladder, on the other hand, presents serious ergonomic problems, like, weight carrying and increased risk of accidents to the electrician. Aiming to develop a vehicle capable of aggregating the advantages of the two approaches mentioned, as simplicity, reduced operating costs, reduced footprint during work and smaller size - allowing to be mounted in lighter vehicles, but providing ergonomics and safety to the electrician, a series of studies were developed at the Escola Politécnica of São Paulo University, in partnership with the CPFL power company. The proposed device is able to be mounted on a pickup truck and to, effectively, work with the maintenance of public lighting, being a lighter type of aerial bucket with three degrees of freedom, controlled by power actuators, and with a wireless remote control for operation by the electrician. In comparison with previous versions, the version IV has reduced weight, with the structure made of aluminum, electrical protection bucket for the electrician, hydraulic actuators for positioning and emergency fall-lock.*

Keywords: *power distribution maintenance, elevators, inspection, ergonomics*

1. INTRODUCTION

Almost all maintenance processes make use of large and heavy equipments, requiring long working period and a large physical area, making difficult to attend all service calls. The majority of maintenance activities are still executed using conventional tools that require the electrician effort. Besides that, in recent years, it was observed an increasing in the average age of the electricians. For example, in the CPFL, this average age is around 40 to 50 years and it is consequence of changes in the labor legislation. Concomitantly, the legislation is being constantly modernized to establish rigorous statements to assure safety to the electricians. To improve the electrician safeness, assuring the quality and efficiency in the execution of the maintenance tasks, electric power companies expends great effort toward standardization of the power line structures, the components used in the structures, the procedures for each maintenance activity and the tools used.

With the advance in the Mechatronics and Robotics technology, many electric power companies around the world are expending efforts aiming the automation of maintenance activity. In this sense, one representative example is the robot that was developed by Kyushu Electric Power Company (KEPCO, Japan), jointly with the Yaskawa Electric Co. (Japan, Nio1993). That robot was designed to be used in the maintenance of live power distribution networks. Among other features, it is equipped with cooperative control, environment recognizing and other advanced functions. Besides this

robot, other Japanese electric power companies developed other robots. However, experiences in these companies showed that the introduction of equipments of very high level of automation is not effective in the maintenance activity. Despite the easier access to the automation technology, in countries like USA and Japan, the majority of maintenance tasks are still made exclusively by electricians using hot sticks, ladder and bucket cars. These facts highlight the importance of defining correctly the level of the automation to be introduced in the maintenance activity. The strategy adopted by CPFL, jointly with the Sao Paulo University researcher team, is to: i) identify maintenance activity of higher risk for the electrician based on an ergonomics study, and ii) for each selected activity, develop a tool that supports the electrician work, defining the adequate level of automation. The goal is not the reduction in the number of electricians, but improvements in the safeness of the electrician assuring the same or more efficiency in the task.

An ergonomic study of the maintenance activities in the CPFL was conducted and it pointed sorts of tasks that offer potential risk to the electricians. The main examples are activities involving the use of wood or glass-fiber ladder and the tree trimming activity using a hydraulic chain saw. In the tree trimming activity, electricians go to a high position near the live power line using a double aerial bucket. One electrician holds the branches to be trimmed and the other trims it with the hydraulic chain saw. Frequently, tree branches are at positions that are very difficult to reach, forcing the electrician to take uncomfortable postures. After some operations, the electricians get tired, increasing the risk of making mistakes that could result in injuries. To aid the electrician in the tree-trimming task, this project developed two devices: a balancer attached to the bucket (Fig.1) and a suit type balancer (Fig.2) (Roncolato2010). Both devices reduce the effort of the electrician to hold and handle the hydraulic chain saw. These devices were intentionally designed to not use electrical motor, sensors or any kind of automatic control.

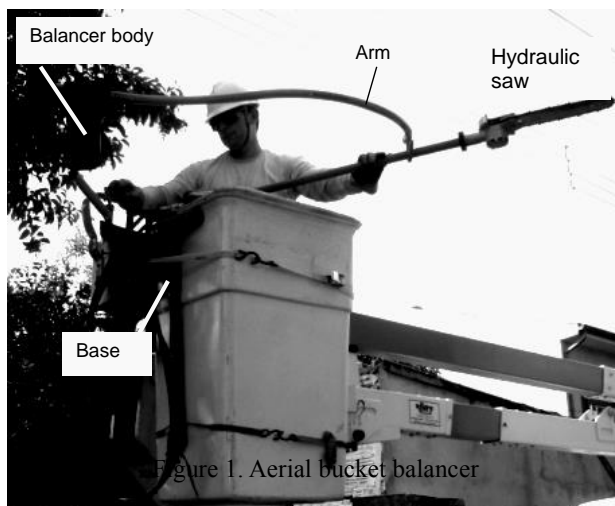

Figure 1. Aerial bucket balancer

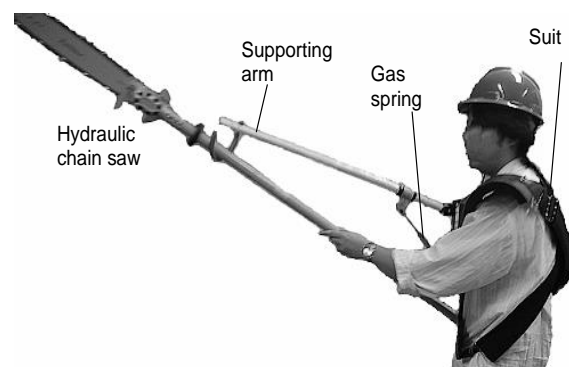

Figure 2. Suit type balancer

In tasks involving the use of a ladder, the ergonomic study showed that the main problems are the manipulation of the ladder, the uncomfortable feet position on the ladder step and the risk of fall from a high position. Analyzing the tasks that make usage of the ladder, it was observed that these tasks could be divided into two classes: inspection and maintenance. The inspection activities could be done from the ground with the aid of a device without requiring the ladder. That is, the electrician can execute the inspection from the ground level. Thus, a device shown in Fig.3 was developed. The device, named pole type robot, has a telescopic and flexible structure that conducts a video camera and other kind of sensors to the level of the cross-arm and send, for example, images of the power line components to the electrician located in the ground level (Cores2012).

Concerning maintenance, the climbing of the electrician to high positions is still mandatory. As mentioned before, the usage of the robot manipulators operated from the ground has been demonstrated as undesirable solution. In this case, in order to improve the safety and efficiency, an automatic elevator was developed and it is being updated since then. The use of an aerial bucket is a very efficient solution, however it is still a high cost solution. Besides, the aerial bucket involves the use of relatively large size trucks. This is inconvenient in urban regions with narrow streets, which is peculiar to Brazilian cities. Thus, this project established as one goal the development of an elevator that conducts the electrician to the level of the power lines without requiring physical effort from the electrician and in a safe way. Moreover, it was set as design requirement the size and weight compatible to a pick-up type vehicle. Until now, three versions of the elevator were developed. The pioneer model named Elevator I (Fig.4) has a steel structure and has only two degrees of freedom: the elevation of the platform and the inclination of the column (Roncolato2008). The Elevator II (Fig.5) is also made of steel but has, besides the mobility of the Elevator I, the possibility to rotate the column (Roncolato2010). While Elevator I focuses only the maintenance of lamps of the public illumination system, the Elevator II, focuses also the maintenance of components of secondary power distribution line attached to the pole. In all versions, the electrician stands in a platform and commands the motion of the platform by a remote control unit.

Motions are monitored by sensors and controlled by a programmable logic controller (PLC).

As to show the incremental improvement achieved in the Elevator functionality and features, this work presents the latest version of the device, the Elevator III and the Elevator IV. The most important difference of these devices and the previous is the main structure constructed in aluminum, resulting in a lighter device. Both can be installed in a smaller vehicle.

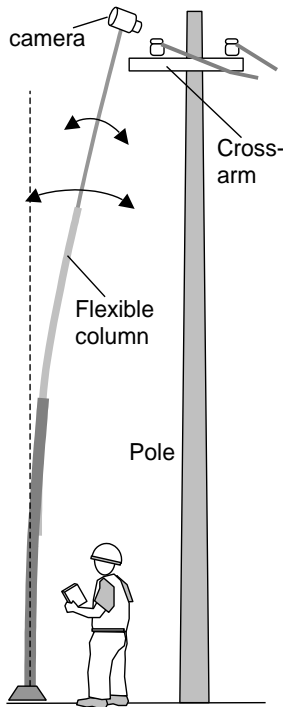

Figure 3. Pole type robot

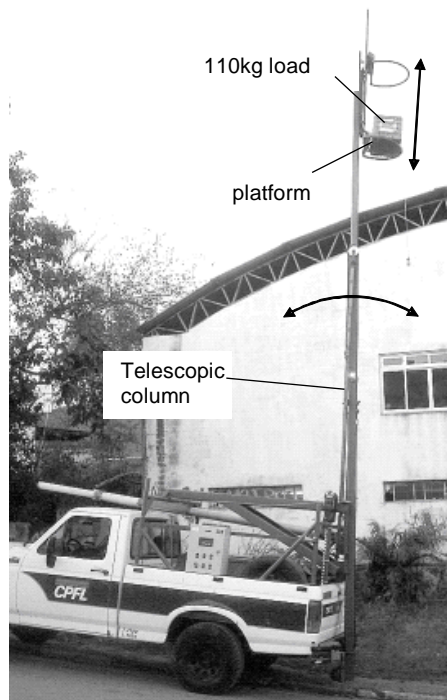

Figure 4. Elevator I

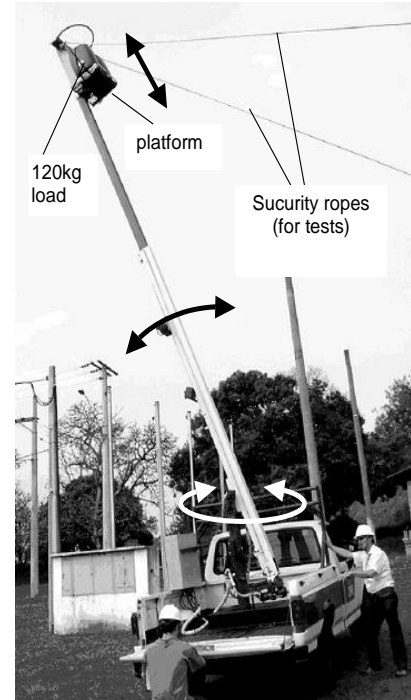

Figure 5. Elevator II

2. THE ELEVATOR III AND IV

As in the previous versions of Elevators, the goal is the development of a device capable of aggregating the advantages of the aerial bucket and the light truck with the ladder. Some requirements are listed:

- Simplicity
- Reduced operational costs
- Reduced footprint during work
- To be installed in light pick-up type vehicle
- Ergonomics and safe working conditions to the electrician

Concerning working volume, Fig.6 shows the volume considered in the development of the Elevator II. Same volume is considered for Elevators III and IV. This volume is such that enables the electrician to reach all components of the distribution line around the pole.

The following mobility is considered (Fig.6):

- Set the main column in the vertical working position or unset to the horizontal transportation position;
- Move the platform where the electrician stands, upward or downward;
- Incline the column around a horizontal axis and;
- Rotate the column around a vertical axis.

Also, the following specifications are established to Elevator III and IV:

- Maximum height to be reached by the electrician: 9m from the ground;
- Maximum inclination of the column: 15° from the vertical line;
- Maximum rotation of the column: ±90° from the longitudinal axis of the truck and;
- Adequate dimensions and weight to be installed in a light truck.

The Elevator III differs from the Elevator IV mainly in the aspect of electrical isolation. For this reason, the explanation will be restricted to the Elevator IV.

Compared with previous versions, Elevator III and IV are designed to feature a sort of improvements concerning

speed, safety on motions and mainly concerning weight. In the previous two prototypes, columns were made of steel. The steel has been replaced by aluminum and the structure redesigned so as to keep the structural strength and reduce the device weight. This enables the installation of the Elevator in a smaller vehicle. Also, a more compact device avoid the modification or removal of cabinets that are usually installed in the vehicles to store a variety of tools and spare components to execute the maintenance of the distribution line. In the previous versions, the column was inclined or rotated directly by electric motors coupled to a mechanical reduction system. However, these electrical motors are replaced by hydraulic ones, thus reducing the noise, increasing the speed and enhancing the controllability of motions.

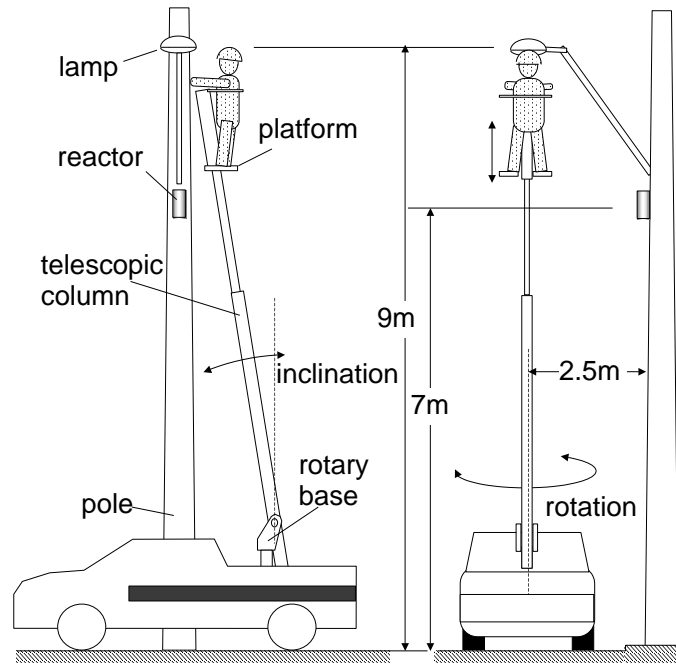

Figure 6. Mobility of the Elevator

2.1 Mechanics

The vehicle was structurally reinforced with aluminum and the two cabinets were kept at the back. The whole structure is designed to be secure and light-weight. The column of the elevator is made of aluminum. Two aluminum shapes are assembled to compose a telescopic central column along by the platform runs. Those shapes are shown in Fig.7. Holes are machined in the internal structure for weight reduction. Structural recalculations resulted in smaller dimensions, however the cross-section of shapes was increased to minimize the amount of deformation of the structure when loaded.

Instead of a simple metallic platform, the Elevator IV is equipped with a bucket molded entirely in fiberglass. Also a segment of fiberglass made shape is inserted in the internal shape as shown in Fig.8. A 1.5ton capacity electrical winch lifts the bucket through steel cables. The final portion of the cable, i.e. the segment between the steel wire and the bucket is tied by dielectric material rope. All these procedures assure the electric isolation of the electrician. The non-conducting rope is to be installed in the prototype shown in Fig.8.

The bucket has nylon slabs to reduce friction when sliding through the column. For the same purpose, similar slabs are also installed between the internal and external shape.

The electric winch, located at the bottom of the column, lifts the bucket. While the bucket moves upward, the bucket reaches the mechanical stop, at the end of the first stage of the telescopic mechanism. From this point, the winch starts to lift the second stage of the telescopic column and the bucket together. Part of the telescopic mechanism is shown in Fig.9. In addition to nylon slabs, wheels provide a smooth sliding of the internal shape inside the external shape.

A hydraulic piston, attached to the column, provides the inclination motion of the column. This includes the motion of setting the column to the working position and resting the column into transportation position. The mechanism is shown in Fig.10. The rotation of the column is provided by a hydraulic motor that drives a pinion coupled to an internally toothed wheel (Fig.11 and 12). This motor is equipped with a hydraulic brake so as to avoid the column from rotating while the motor is not operating. A mini hydraulic unit supplies the hydraulic power for all hydraulic actuators of the elevator (Fig.11). This unit is driven by an electric motor, thus the Elevator can operate using batteries with the

vehicle engine turned off.

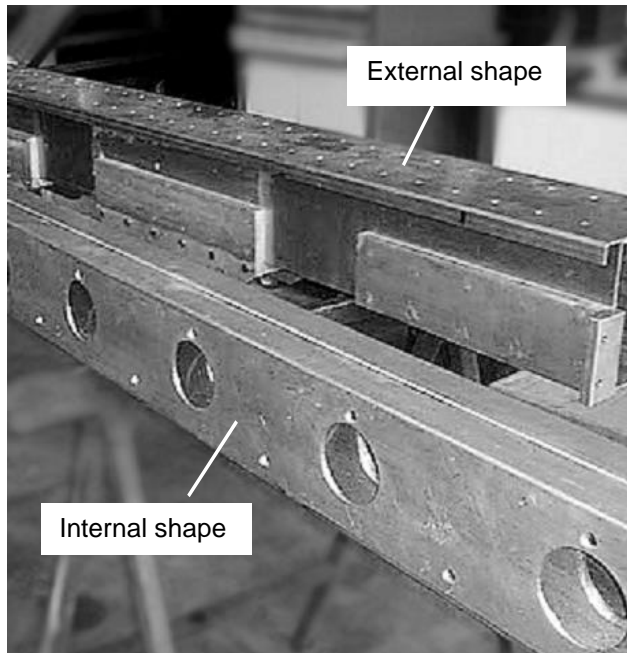

Figure 7. Aluminum column shapes

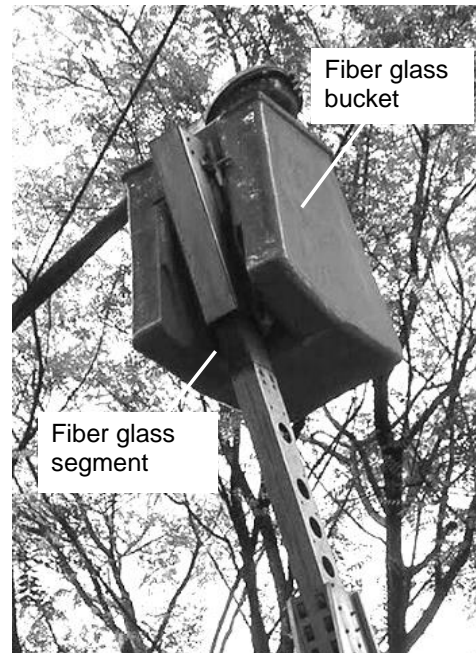

Figure 8. Fiber-glass for isolation

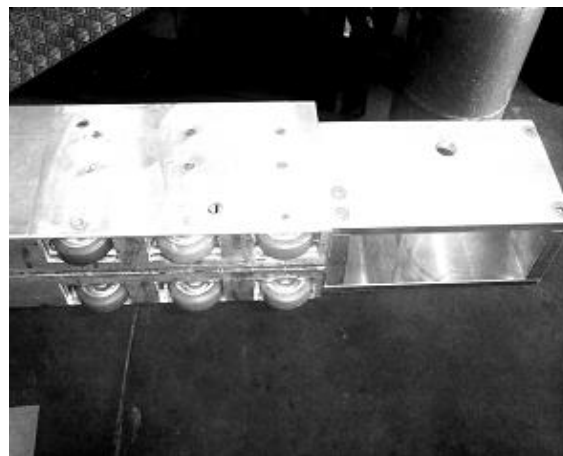

Figure 9. Telescopic mechanism

2.2 Electronics and control

The operation of the Elevator IV is monitored by a sort of sensors and controlled by a Programmable Logic Controller (PLC). Figure 13 shows the control panel of the Elevator. This panel has basic movement controls that will be detailed later. The Elevator is operated using this panel in an emergency situation. Under normal conditions, the Elevator is operated using a remote control unit that the electrician carries inside the bucket. The remote control unit communicates with the PLC panel through radio frequency.

Figure 14 illustrates sensor locations and the control basics. The panel is the main control component. It has simple movement buttons, pre-programmed tasks buttons, a turn on and turn off key and an emergence button. The simple movement buttons are: **Front**, **Back**, **Right**, **Left**, **Up** and **Down**. The pre-programmed task buttons are: **Arm** and **Disarm**. The buttons functions are as follow:

- **Front**: Incline the column toward rested position;
- **Back**: Incline the column back to the vertical position;
- **Right**: Rotates the column to the right;

- **Left:** Rotates the elevator to the left;
- **Up:** Basket upward;
- **Down:** Basket downward;
- **Arm:** Column to the vertical working position and the bucket to the inferior limit position;
- **Disarm:** Column to the horizontal transportation position (if the basket is empty and the column centered);
- **Emergency:** Remote control ignored, any automatic movement stopped and commands of the control panel obeyed ignoring sensor signals.

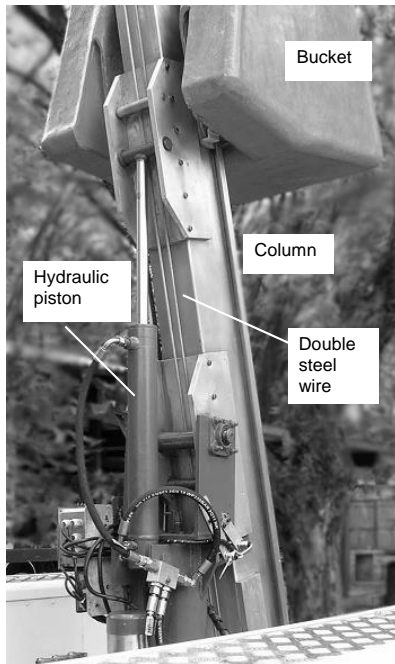

Figure 10. Column inclining mechanism

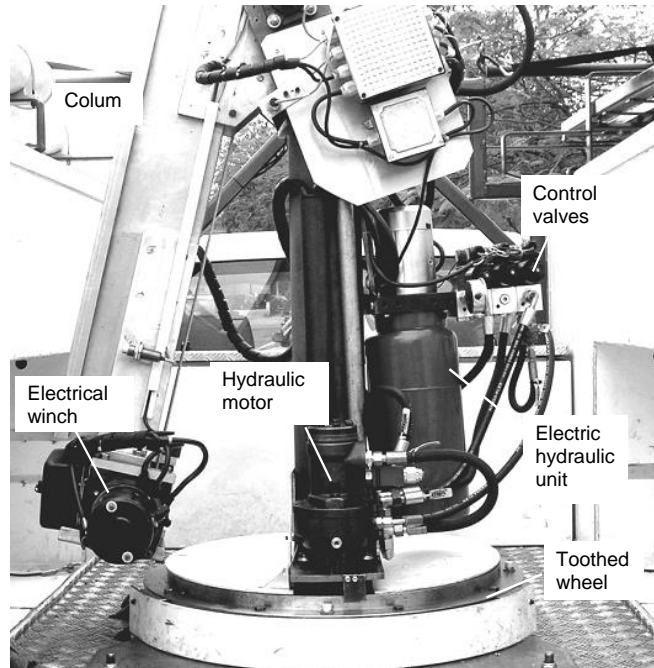

Figure 11. Rotary base and the electrical winch

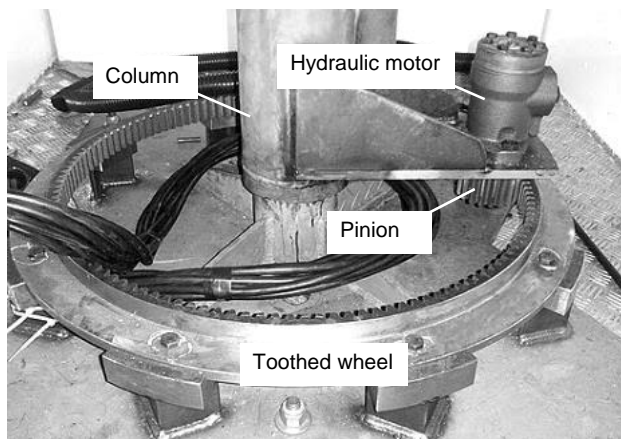

Figure 12. Rotation system mechanism



Figure 13. Control panel

3. TESTS

Various tests were conducted to ensure the structural safety and correct operation of the Elevator IV. After that, the prototype was tested in field. Fig.15 shows the Elevator IV with a load of 120kg set in the bucket, the bucket elevated until the maximum reachable height and the column inclined at 30°, 15° more than the maximum stipulated angle. This is one of several critical conditions tested in the field. In all situations, no abnormal deformation of the structure was observed and the vehicle with the Elevator kept its stability. Also, no additional device was added to the vehicle

suspension system to assure the stability. The Elevator IV is enough compact so that it was not necessary removing the cabinets to store tools and components for maintenance.

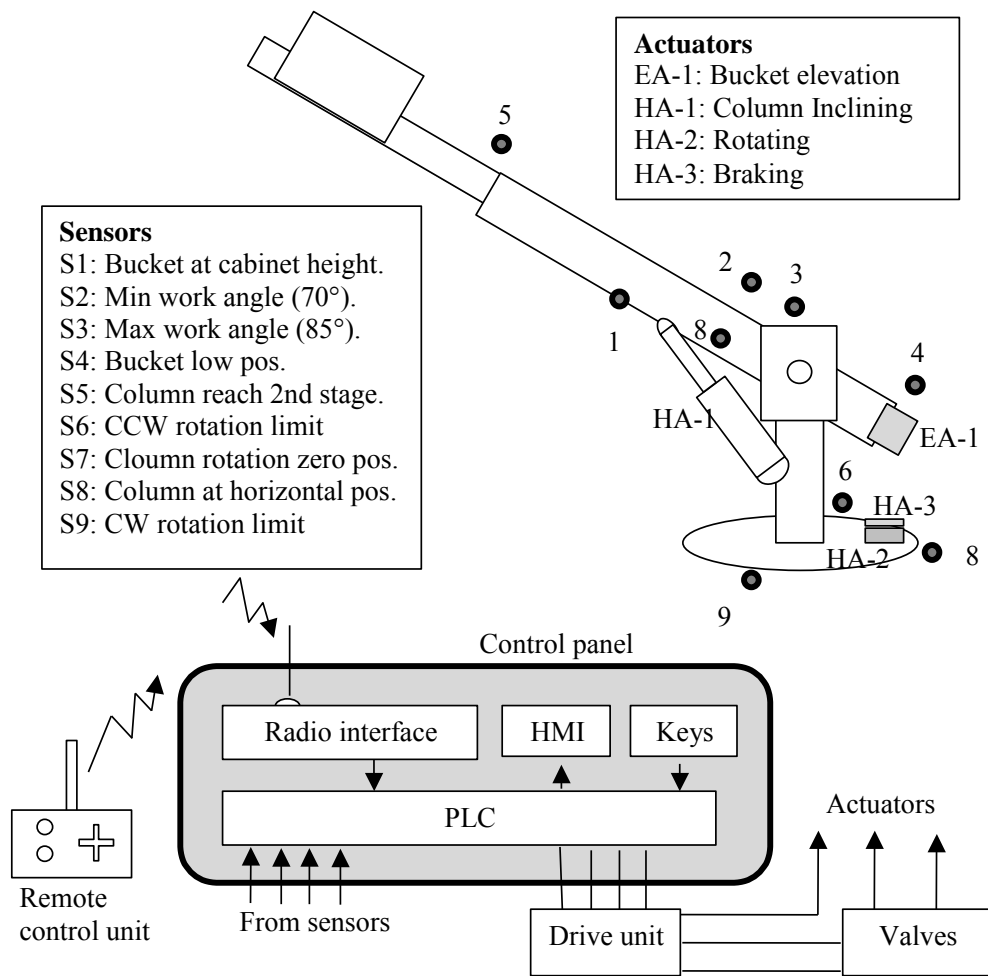

Figure 14. Control system of the Elevator IV

4. CONCLUSIONS

The CPFL and the Escola Politécnica of São Paulo University are jointly conducting a project that aims improvements in the working conditions of the electricians in the maintenance of electric power distribution. By applying Mechatronics and Robotics, the objective is to develop devices that reduce risks of immediate accidents or long term injuries to electricians. Based on an ergonomic study, the project focused two activities: the tree trimming and the work at high positions. This work reported the most recent device developed for helping the electrician to conduct maintenance of power distribution lines, an automatic elevator. The elevator here presented, the Elevator IV, is the last version of three versions developed previously. A prototype of the Elevator IV demonstrated to be able to conduct a load of 120kg to a height up to 9m from the ground and has mobility enough to reach main components of a distribution line. This includes lamps of a public illumination system. The Elevator IV, besides featuring electrical isolation for working in live lines, has weight and dimensions adequate to be installed in a pick-up type light truck.

The conclusion of the development of the Elevator IV concludes a cycle of studies concerning improvements in the working conditions of electricians in the maintenance of power distribution lines. Prototypes of all developed devices are now being tested in field so as to effectively introduce them to the maintenance activity. The key point in the development process of all devices was the correct definition of the automation level of each device. This depends not only on the access to the most advanced Mechatronics and Robotics technology and the cost. It depends on the long term policy of the enterprise concerning human resource, the level of satisfaction of electricians and other peculiarities of the Brazilian power distribution system. Because of that solutions adopted in other countries may not be effective in Brazil.

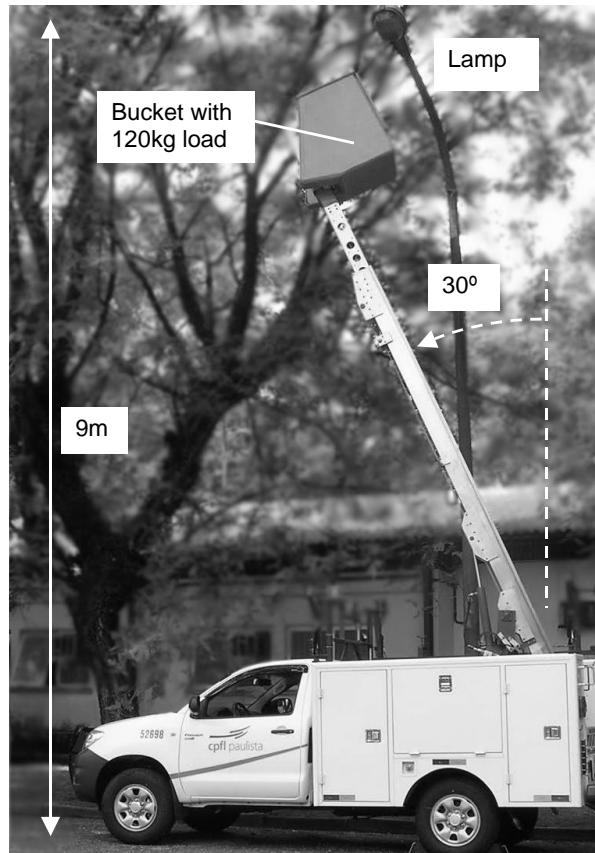

Figure 15. Load test of the Elevator IV

5. ACKNOWLEDGEMENTS

Authors acknowledge Brazilian National Electric Energy Agency (ANEEL, Brazil), Coordination for the Improvement of Higher Education Personnel (CAPES, Brazil) and Foundation for the Technological Development of Engineering (FDTE, Brazil) for supporting this project.

6. REFERENCES

- Cores, V.F., Horikawa, O., Hirakawa, A.R. and Chamas, A. Filho, 2012. "Pole type robot for distribution power line inspection". *2nd International Conference on Applied Robotics for the Power Industry – CARPI 2012*.
- Nio, S. and Maruyama, Y., 1993. "Remote-operated robotic system for live-line maintenance work". *ESMO-93 Sixth International Conference on Transmission and Distribution Construction and Live Line Maintenance*, pp. 425-435.
- Roncolato, R.A., Romanelli, N., Hirakawa, A., Horikawa, O., Vieira, D., Yamamoto, R. I. and Cores, V. F., 2008. "Robotics applied for safety improvement in the power distribution lines maintenance". *Proceedings of 2008 PES Transmission and Distribution Conference*.
- Roncolato, R.A., Romanelli, N., Hirakawa, A.R., Horikawa, O., Vieira, D., Yamamoto, R. I., Cores, V. F., Svezuti, V. and Lopes, I.P., 2010. "Robotics applied to work conditions improvement in power distribution lines maintenance". *International Conference on Applied Robotics for the Power Industry*, Vol. 1, pp. 1-6.

7. RESPONSIBILITY NOTICE

The authors are the only responsible for the printed material included in this paper.