

GENERATION OF ANTHROPOMORPHIC MOVEMENTS FOR AN ACTIVE ORTHOSIS FOR LOWER LIMBS

Márcio Valério de Araújo, marcio@ct.ufrn.br

Pablo Javier Alsina, pablo@dca.ufrn.br

Lennedy Campos Soares, lennedy@dca.ufrn.br

Adelardo A. Dantas de Medeiros, adelardo@dca.ufrn.br

Universidade Federal do Rio Grande do Norte, Lagoa Nova, Natal, RN

Abstract. *The growing concern for improving the quality of life brings a new application for robotic devices every day. Exoskeletons and active orthoses are robotic mechanisms developed to assist in the mobility of workers, militaries, elders and people with some form of paraplegia. These devices can increase strength, speed and endurance of users such applications motivate the interest of several research groups around the world. In this paper we present the prototype of an active orthosis for lower limbs used to assist in moving people with limited mobility. The prototype is equipped with an electronic board, rechargeable batteries and a man-machine interface responsible for identify the movements selected by the user and sent to the embedded computer. The movements of the orthosis are accomplished by electric motors attached at the hip and knee joints..*

Keywords: *Active Orthoses, Human Gait, Embedded Computer*

1. INTRODUCTION

Active orthoses are noninvasive orthopedic mechanisms, externally positioned, whose function is to align, prevent or correct deformities, or even to improve the body's movable parts function. Active orthoses for lower limbs use actuators to produce motion in the lower limbs of an individual who is unable to perform such moves by itself whether it happens due to some kind of paralysis, like spinal cord injury, or even because of lack of strength, in the case of people with muscular problems.

The active orthosis' prototype for the lower limbs, developed by the Universidade Federal do Rio Grande do Norte is a pseudo anthropomorphic mechanism consisted basically of a set of rigid structures joined by rotational joints and electrical actuators. The development project of the active orthosis of the previously mentioned institution is called *Ortholeg*.

Right now the prototype has only actuators in the knee and hip joints. Each joint has only one degree of freedom, enough to produce the extension and flexion movements at both joints, allowing the user to walk straight, to go up and down stairs, to sit and to stand. Its main application is to allow people without movement of the legs to move with a gait pattern similar to a healthy person. In this first version, the prototype allows only motions in the sagittal plane¹.

All movements are selected by a human-machine interface that sends high level commands via USB port for the embedded computer. The interface is a keyboard with a set of buttons with defined functions. In turn, the embedded computer is responsible for interpreting these commands and to send the reference angles to the actuators' controller board.

Figure 1 shows the active orthosis called *Ortholeg* worn by the user, and Fig.2 shows part of the embedded electronic system located on the back of the mechanical structure.

The orthosis' prototype is made by a mechanic structure providing support to disabled people. The orthosis' joint's movement is realized by 4 actuators controlled by a embedded control system. Initially, the prototype was projected to people whose weight has been between 50 and 60 Kg and height has been between 1.55 and 1.65 and prototype's weight is 17 Kg.

The main contribution of the active orthosis previously shown is to allow paraplegics or others with special needs to walk, to climb stairs, to sit and to stand more naturally as possible. The use of active orthoses by disabled people contributes to the insertion of these people in the labor market, improving their quality of life.

Currently, several research groups around the world are already developing works related to active orthoses with the aim of helping people with special needs, military application and to increase the physical force of workers (Dollar and Hugh, 2008; Seireng and Grundmann, 1981; Mohammed and Yacine, 2009; Kong and Jeon, 2006; Mori *et al.*, 2005).

2. Actives Orthoses

The primary purpose of a orthosis is to improve features such as: applying forces or subtract from the body in a controlled manner to protect a certain part, restrict or change the movement to prevent or correct a deformity, and compensate for a weakness or deformity.

Initially, the active orthoses were basically developed from passive orthoses in order to more faithfully reproduce the

¹The sagittal plane is that one formed by the longitudinal and frontal axis, dividing the human body into left and right halves. It is used to study movements performed forward or backward.



Figure 1. User wearing the prototype of the active orthosis for lower limbs

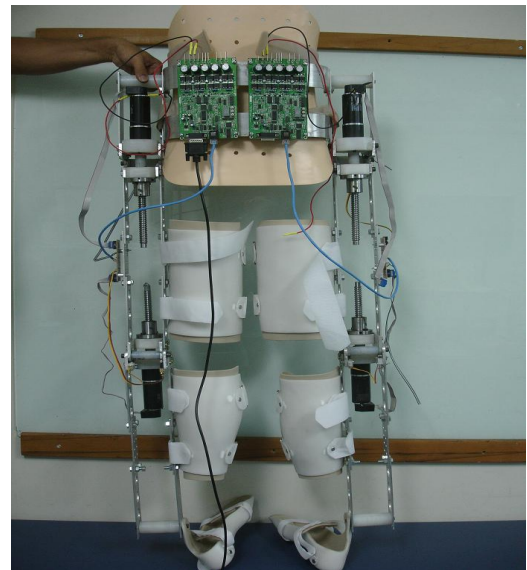

Figure 2. Posterior view of the *Ortholeg*

anthropomorphic movements² to assist in the rehabilitation of patients. Functional rehabilitation exercises using active orthoses are useful in the recovery phase, since the movements generated by bracing stimulate the central nervous system to relearn the movements lost or partially lost.

Recently, several groups have developed active orthoses to help handicap people, to move and perform daily tasks (Hian *et al.*, 2009; Jerry *et al.*, 2004; Ohta, 2007; Fleischer *et al.*, 2005; Schmitt *et al.*, 2004; Mavroidis *et al.*, 2005; Saito, 2005; Costa and Caldwell, 2006).

On Brazil, the orthoses are still in development and testing in many research labs (Siqueira *et al.*, 2008; do Nascimento *et al.*, 2008; Araújo *et al.*, 2009), and still has no estimate of when a final marketable product will be available to consumers. Until there remains work to develop orthoses with a lower price, more efficient, safer and more accessible to the average population.

3. Ortholeg's hardware architecture

The prototype is equipped with an embedded electronic system responsible for making the closed loop control of the prototype movements. The selections of these moves are made from buttons pressed on a keyboard connected to embedded computer. The Fig. 3 shows the architecture of the electronic system to control the orthosis.

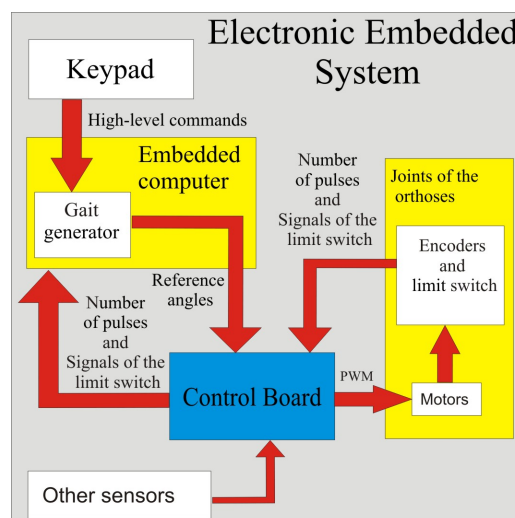

Figure 3. Hardware architecture.

²Similar to the movements performed by the human body

The embedded electronic system is used to interpret high level commands pre-defined and determine the type of movement that orthosis will do, generate referrals for angular joints of the orthosis according to the pattern of movement desired by the user, trigger and control the orthosis actuators in accordance with the references and angular information collected encoders and limit switches.

The current state of the orthosis is measured by the position of the incremental encoders of the motors and limit switches attached at each joint. Each encoder generates a sequence of pulses whose frequency is proportional to engine speed, providing the angular measurements with good accuracy of the relative position of each joint, allowing precise control of orthosis positioning. The limit switches prevents the joints from exceeding the mechanical limits, and provides a reference to measure the angles.

The computer communicates with the drive boards via the RS 232 communication protocol. The driver boards are responsible for controlling low-level position of the electrical motor.

4. Experimental Results

The first stage of the experiment was watched positions, orientations, velocities and accelerations of body segments while a healthy subject performing a human gait. Further the experiment collected information on other types of movements such as sitting and standing, walking at different speeds, up and down a stair.

The kinematic analysis was used to obtain the movement's parameters. This technique allows to collect the necessary images of the segments and after it can do more detailed analysis of the gait cycle.

To obtain information through the cinematic was necessary, first choose the body parts and identify them at strategic points, by placing special markers that reflect infrared light coming from a set of cameras designed to capture the frequency.

The Fig. 4 exhibits a person with reflexive markers on body. The Fig. 5 shows the degree on sagittal plane of hip's joint and knee's joint which will be analyzed in this work.



Figure 4. Patient with reflective markers attached to the body part in analyzing

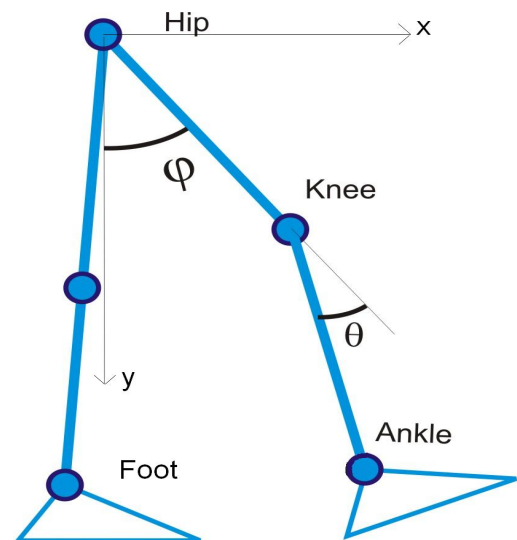

Figure 5. Relative joint's degree from the prototype's leg

With the data collected from the walk was made a Gauss interpolation of second order. After interpolation was obtained the knee's angle function and fifth-order interpolation for the hip function. Figure 6 and 7 shows the data collected and generated curves for the angle θ and φ as a function of the gait. For the other orthosis possible movements a similar approach was made to obtain the reference functions.

Based on joint angles changes of healthy user to perform movements, the prototype was preprogrammed initially only with five movements types: the first was only the start of it, which served to position the orthosis in the upright position, regardless the previous position. The second movement set was sitting, followed by the lifting movement, up and down stairs and finally, a gait pattern.

Following are shown the variations of the angles of the joints of the orthosis *Ortholeg* compared with the reference angles. The variation of joint angles were obtained through of data collected by the encoders installed on each electrical motor.

Figure 8 shows the variation in relative knee angle θ collected by the encoder. The variation in relative knee angle is compared to the angular reference function. Figure 9 shows the variation of the relative hip's joint angle φ collected by the encoder function compared with the reference angle while performing a gait pattern performed by the prototype.

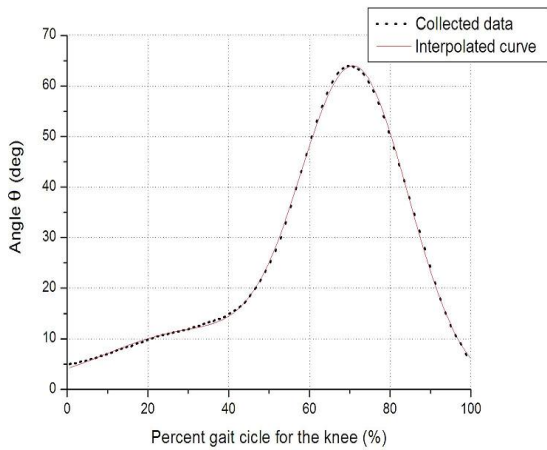

Figure 6. Data collected curve in the kinematics compared with the curve of the reference percentage.

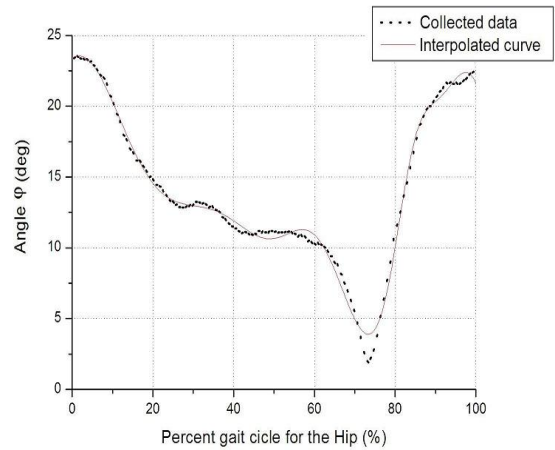

Figure 7. Data collected curve in the kinematics compared with the curve of the reference percentage.

The observed delay between reference angles and the corresponding real orthosis angles is due to communication delays between the embedded computer and the power drive control board.

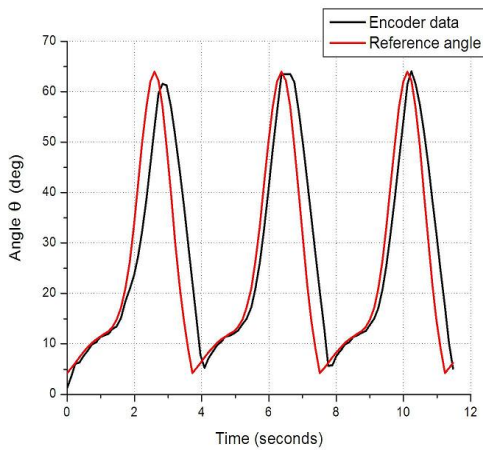

Figure 8. Knee's encoder data compared with its reference signal

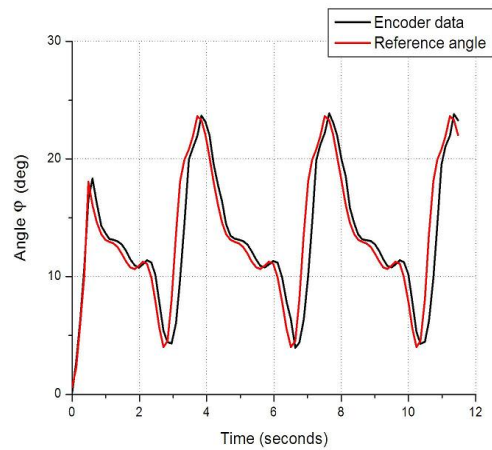

Figure 9. Hip's encoder data compared with its reference signal

The periodic motion of walking is a gait cycle and lasts about 4 seconds, see Fig. 8.

Figure 10 shows the relative variation of the hip joint angle φ and the relative angle variation θ of the knee joint during the orthosis motion seating performance. On graph was showed the orthosis took approximately 2.5 seconds to change from sitting to standing position.

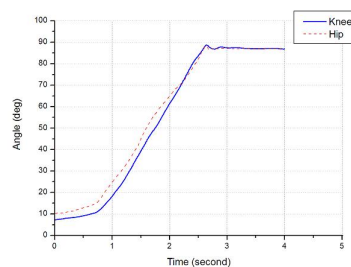

Figure 10. Relative hip and knee angles variation while sitting

The movement of sitting, held by the orthosis, is not anthropomorphic, due to mechanical limitations of the prototype

built. This movement is not a function of angular reference, just leaving the orthosis standing position to a position with $\theta = 90$ and $\varphi = 90$.

The climbing stairs motion was performed as follows: The orthosis rose step by step, always starting the movement with its right leg followed by the left leg, both stopping at the same step. In this way, the right leg movements are wider than the left leg movements. This form of climbing stairs is widely used by elderly or people with walking difficulties. Due to security concerns, the total time to climb a step was chosen around 4 seconds.

Figure 11 shows the relative angle variation of the right hip joint. Figure 12 shows the relative angle variation of the left hip joint motion during the course of a stairway.

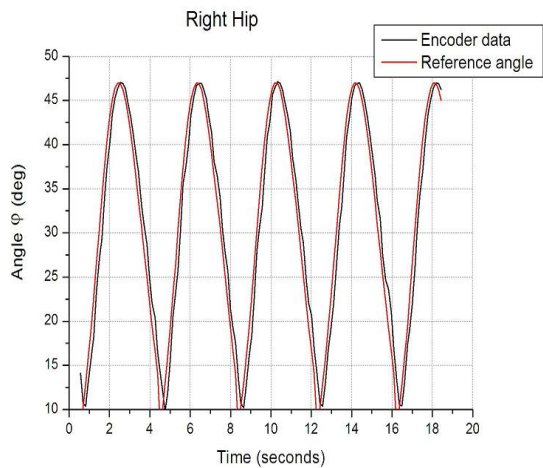

Figure 11. Change the right hip joint angle versus time

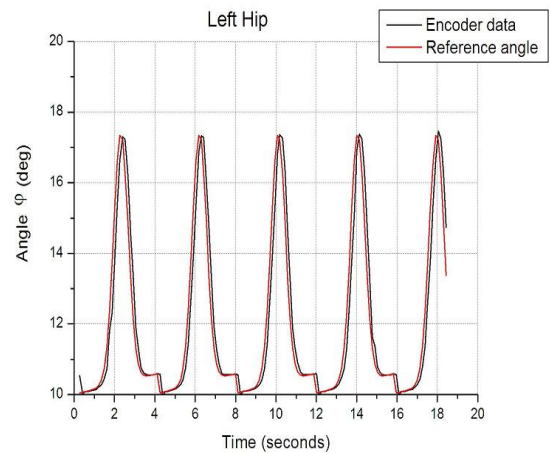

Figure 12. Change the left hip joint angle versus time

Figure 13 shows the relative angle variation of the right knee joint and the Fig. 14 shows the relative angle variation of the left knee joint motion during the course of a stairway.

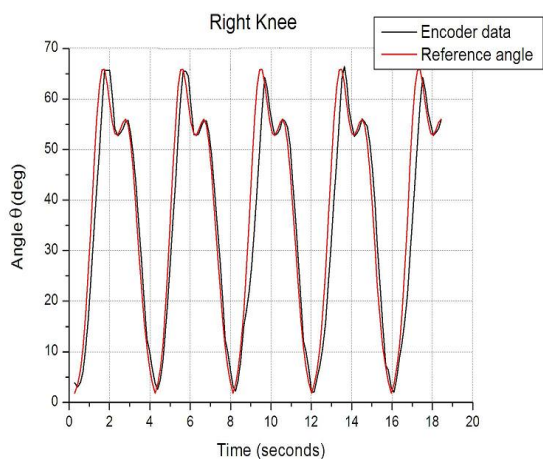

Figure 13. The right knee angle joint change versus time

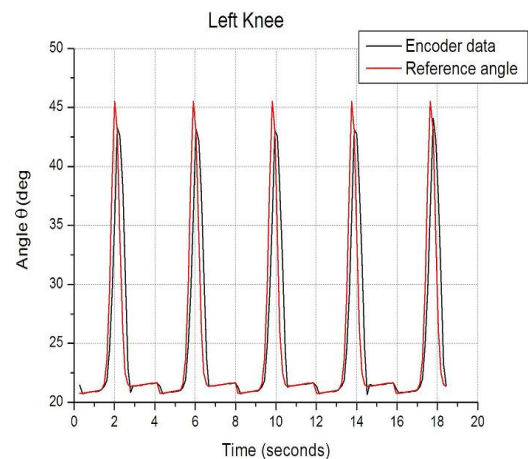

Figure 14. The left knee angle joint change versus time

5. Conclusion

This work presented the design of an active orthosis called *Ortholeg* used for people with paraplegia in the lower limbs. Every day is increasing considerably the number of active orthoses, many research institutions and companies are working to produce active orthoses easy to use, secure, intelligent, comfortable, with reduced price and maximum autonomy. With the improvement of the active orthosis it can be used to rehabilitate patients who have lost partial movement of the lower limbs. This is great motivation for those working with the development of physiotherapy equipment. The human walk promotes the autonomy of the patients, which is why the recovery of this movement with the use of robotic devices is of huge importance in both physical and psychological aspects. This would be another significant contribution.

The prototype allows, in this initial state, perform the movements of walking, sitting, standing, climbing and descending stairs carrying a person up to 60 kg. With the advance of research, in the future, this device will promote a better

quality of life of disabled locomotion. The *Ortholeg* orthosis has a hardware architecture and software capable of generating the reference angles and controlling the actuators so that they can move the mechanical structure according to the motion selected by the user. The graphics, collected from the prototype showed that the orthosis is capable of playing three types of basic movements. These movements are necessary for a paraplegic user, have minimum autonomy to move in an unstructured environments.

6. REFERENCES

- Araújo, M.V., Alsina, P.J., Medeiros, A.A.D., Araújo, F.M.U., Pinheiro, J.P., Domingos, E.C. and Silva, J.S., 2009. "Development of an active orthosis prototype for lower limbs". In *20th International Congress of Mechanical Engineering, Gramado, Brazil*.
- Costa, N. and Caldwell, D., 2006. "Control of a biomimetic soft actuated 10 dof lower body exoskeleton". In *Proceedings First IEEE RASEMBS Int. Conf. on Biomedical Robotics and Biomechanics, Pisa, Italy*. pp. 495 – 501.
- do Nascimento, B.G., Vimieiro, C.B.S., Nagem, D.A.P. and Pinotti, M., 2008. "Hip orthosis powered by pneumatic artificial muscle: Voluntary activation in absence of myoelectrical signal". *Artificial Organs*, Vol. 32, No. 4, pp. 317–322.
- Dollar, A.M. and Hugh, H., 2008. "Lower extremity exoskeletons and active orthoses: challenges and state-of-the-art". *IEEE Transactions on Robotics*, Vol. 24(1), p. 144.
- Fleischer, C., Homme, G. and Reinicke, C., 2005. "Predicting the intended motion with emg signals for an exoskeleton orthosis controller". In *Proceedings of the 2005 IEEE International Conference on Robotics and Autonomous Systems*. pp. 2029 – 2034.
- Hian, K., Jerryll, H., Matthew, M., Travis, C., Jerry, E. and Peter, N., 2009. "Development of the ihmc mobility assist exoskeleton". In *ICRA*. pp. 2556–2562.
- Jerry, E., Benjamin, T., Christopher, J. and Steven, H., 2004. "The roboknee an exoskeleton for enhancing strength and endurance during walking". In *ICRA*. pp. 2430 – 2435.
- Kong, K. and Jeon, D., 2006. "Design and control of an exoskeleton for the elderly and patients". *IEEE / ASME Transactions on Mechatronics*, Vol. 11, pp. 428 – 432.
- Mavroidis, C., Nikitzuk, J., Weinberg, B., Danaher, G., Jensen, K., Pelletier, P., Prugnarola, J., Stuart, R., Arango, R., Leahey, M., Pavone, R., Provo, A. and Yasevac, D., 2005. "Smart portable rehabilitation devices". *Journal of Neuroengineering and Rehabilitation*, Vol. 2, p. 18.
- Mohammed, S. and Yacine, A., 2009. "Towards intelligent lower limb wearable robots: Challenges and perspectives state of the art". In *Proceedings of the 2008 IEEE International Conference on Robotics and Biomimetics*. pp. 312 – 317.
- Mori, Y., Okada, J. and Takayama, K., 2005. "Development of straight style transfer equipment for lower limbs disabled able". In *Proceedings of IEEE / ASME International Conference on Advanced Intelligent Mechatronics*. pp. 1176 – 1181.
- Ohta, Y., 2007. "A two degree of freedom motor powered gait orthosis for spinal cord injury patients". In *Proceedings of the Institution of Mechanical Engineers Part H Journal of Engineering in Medicine*. pp. 629 – 639.
- Saito, Y., 2005. "Development of externally powered lower limb orthosis with bilateral servo actuator". In *Proceedings of IEEE International Conference on Rehabilitation Robotics*. pp. 394 – 399.
- Schmitt, C., Metrailler, P., AlKhodairy, A., Brodard, R., Fournier, J., Bouri, M. and Clavel, R., 2004. "A study of a knee extension controlled by a closed loop functional electrical stimulation". In *9th Annual Conference of the International FES Society*.
- Seireng, A. and Grundmann, J.G., 1981. "Design of a multitask exoeskeletal walking device for paraplegics". *Biomechanics of Medical Devices*, pp. 569 – 644.
- Siqueira, A.A.G., Jardim, B., Vilela, P.R.C. and Winter, T.F., 2008. "Analysis of gait pattern adaptation algorithms applied in an exoskeleton for lower limbs". In *16th Mediterranean Conf. on Control and Automation, Ajaccio*. pp. 920 – 925.

7. Responsibility notice

The author(s) is (are) the only responsible for the printed material included in this paper