

DESIGN OF A PCB MILLING MACHINE

Rodrigo Basniak, rbasniak@yahoo.com

Márcio Fontana Catapan, catapan@up.edu.br

Positivo University, Professor Pedro Viriato Parigot de Souza Street, 5300. Curitiba, PR. Brazil

Abstract. Nowadays it's hard to find a product without electronic components, and they are getting smaller day after day. Consequently the printed circuit boards used on these products are getting more complex and with thinner tracks. There are many ways to produce these boards and one of them is through electrochemical corrosion, but it does not produce good results. A better process is with milling and a CNC machine. There is a lack of CNC machines for this purpose, so this paper presents the development of a CNC milling machine for printed circuit boards with low manufacturing costs for domestic use. The customer requirements are obtained through a market research and then processed with the use of a QFD matrix to acquire the product requirements. A morphological matrix is then used to obtain all possible solutions for each requirement and they are analyzed with an algorithm to find the best concept for this product. The detailed design comprises the 3D model in a CAD system and the selection of materials. Analytical calculations of the critical components and CAE analysis are factors of extreme importance to obtain a precise result. The FMEA allows an analysis of possible flaws in the final product, which can be eliminated during product development. All this to ensure a lean and robust design, which must absorb all vibration from motors and allow the milling of thin tracks. With the detailed design done it is possible to build the first prototype. Individual components are manufactured and then the mechanical part of the machine is assembled, followed by the electronic assembly. With a functional prototype finished many tests are done to assure that all customer requirements were fulfilled. It's also at this stage that the mathematical models used along the development can be validated.

Keywords: PCB, CNC, milling, design, product development

1. INTRODUCTION

Printed Circuit Boards (PCB) appeared for the first time in the 50's. Since then, the world went through many revolutions on the manufacturing processes. It reduced the costs of these boards to a level where it was possible to insert them into nearly all electronic devices. One of these manufacturing processes is milling. After Second World War the first Computer Numerical Controlled (CNC) machines appeared. It didn't take time to adapt them to the many machining machines existent. This is how the firsts CNC milling were developed and the industry discovered that it was one of the best processes to manufacture PCBs. Even though it's a good choice for mass production, the PCB milling for domestic users is not a good economical option. Based on these arguments this paper presents the development of a low cost CNC milling machine for manufacturing of PCBs by domestic users.

2. THEORETIC FUNDAMENTATION

According to Booker *et al.* (2001), for a product to be competitive, it needs to have low levels of fail. The costs caused by these fails make the major cost category on a product production. Lowering these costs can make the product more competitive and more profitable. Studies found that 75% of quality costs are originated during the design phase, although around 80% of them are not detected until the final test phase or until the product is already in use.

Rozenfeld *et al.* (2006) said that the product development is critical and important process in the companies. The use of a Product Development Process (PDP) can help on reducing these costs and qualities faults significantly.

The methodology adopted is based on the one presented by Rozenfeld *et al.* (2006) and can be seen at Fig. 1.

There are three phases: pre-development, development and after-development. Only the development phase will be detailed on this paper. The specific phases covered on the paper are: informational design, conceptual design, detailed design, prototype production and product testing.

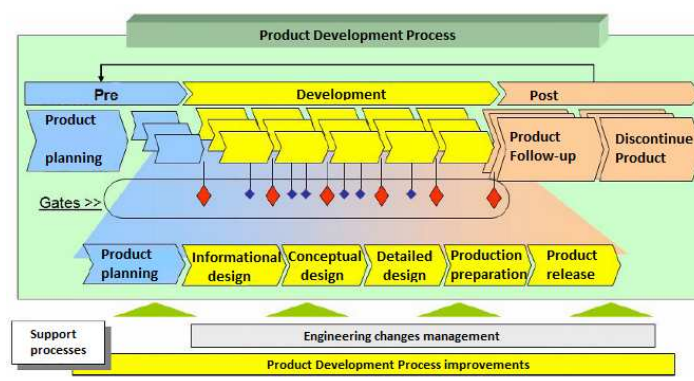


Figure 1. Product Development Process (Rozenfeld *et al.*, 2006)

2.1. Informational Design

The objective of this phase is to develop the most complete set of information, called product goal requirements. These specifications will guide the generation of solutions and provide a theoretic base to the decisions that will be taken in the next phases.

To collect all necessary information from the possible users of the product, a market research was made. It was based on a questionnaire answered by students from electronic courses. After that, some already existent CNC machines for PCB milling were chosen to be analyzed and compared with the new product being developed. The selected machines can be seen at Fig. 2.

Based on this data, the customer requirements were acquired and can be seen at Fig. 3.

Resource	SuperScribe	Accurate A360	JCUT-3030
Tool change	Manual	Manual	Manual
Automatic reference	No	Yes	No
Suction system	Optional	Yes	No
Spindle speed [rpm]	25000	5000-60000	24000
Board fixture	there isn't	there isn't	there isn't
Feed velocity [mm/s]	32	127	67
Resolution [mm]	0,006	0,002	0,025
Acoustic insulation	Optional	No	No
Cut illumination	No	No	No
Actuators	Step motor	Step motor	Step motor
Track minimum width [mm]	0,1	0,1	0,4
Working area [mm ²]	229 x 305	305 x 254 x 22	300x300
Dimensions [mm]	660 x 460 x 381	508 x 432 x 305	750x750x750
Weight [kgf]	-	25	90
Price [US dollars]	8.000,00	9.600,00	10.500,00

Figure 2. Machines chosen to be analyzed and compared with the new product

Customer requirements
Low cost
High precision
PCB fine finishing
Good board fixture
Safety
Durability
Flexibility
Compact
Vibration absorption
Fast

Figure 3. Customer Requirements

The customer and product requirements fill the Quality Function Deployment (QFD) Matrix. Its objective, according to Rozenfeld *et al.* (2006), is to present a consensus to the different product definitions, establishing relations between the customer and product requirements. Basically, the QFD Matrix transfers the “what” onto “how”. The outputs from the QFD Matrix are the goal requirements and are shown at Fig. 4.

Classification	Priority	Product requirements	Score
1°	17,8%	Track minimum width	227
2°	17,7%	Resolution	225
3°	13,2%	Spindle speed	168
4°	9,9%	Feed velocity	126
5°	9,7%	Automatic tool change	123
6°	7,1%	Protection against machining dust	91
7°	7,1%	Board fixture	90
8°	6,6%	Working area	84
9°	5,9%	Dimensions	75
10°	3,6%	Noise insulation	46
11°	1,5%	Cut illumination	19

Figure 4. Goal requirements from the QFD Matrix

2.2. Conceptual Design

It's in this phase that the product is idealized, though ideas free of preconceptions and barriers, hence the problem's essence is maintained.

The first step is to make a functional modeling of the product, which makes possible to represent the product by its functions. This can be seen at Fig. 5.

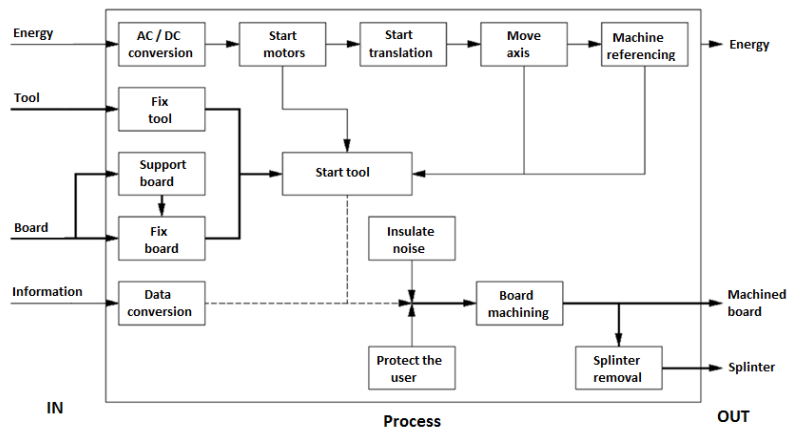


Figure 5. Functional modeling

The morphologic matrix is used to organize all possible design solutions, for each product function, defined at the functional modeling phase. Then the design team can make a great number of possible concepts based on these presented solutions. Figure 6 shows the morphological matrix found for this product. All possible conceptions are then analyzed and compared to the goal requirements to see if they fulfill them or not. Based on this criterion each possible conception is punctuated and the one with the higher result is the best conception for the product. The solutions for the chosen conception can also be seen at Fig. 6.

Figure 7 shows the final result of the conceptual design phase, which is a sketch of the product based on the solutions used of the chosen conception.















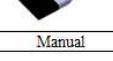


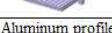

Functions	Alternativas de solução		
Motor actuation	 1.1	 1.2	 1.3
	Screws	Chains	Synchronized belts
	Tool actuation	 2.1	 2.2
Belt		Direct on motor shaft	Gears
Axis moving		 3.1	 3.2
	Square screw	Metric screw	Ball screw
	Board fixture	 4.1	 4.2
Fasteners		Holding plates	Half moon holders
Board support		 5.1	 5.2
	Machined plate with oblongs	Aluminium profiles	Machined plate with holes
	Noise insulation	 6.1	 6.2
Foam		Styrofoam	Felt
Splinter removal		 7.1	 7.2
	Suction	Manual	
	Tool fixture	 8.1	 8.2
Set screw		Chuck key	Conic
Structure reinforcement		 9.1	 9.2
	Aluminum profiles	Laser cuted pieces	Machined

Figure 6. Morphological matrix

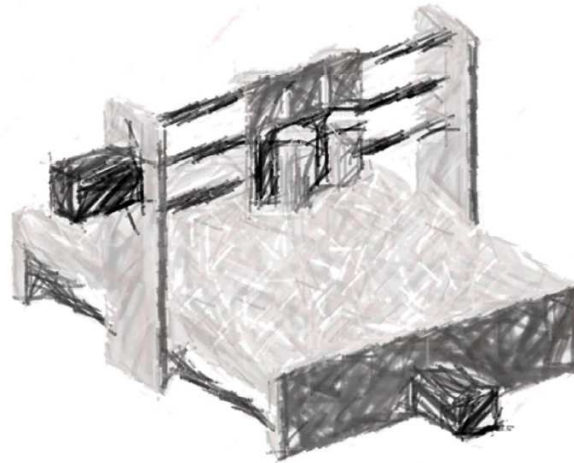


Figure 7. Result of the conceptual design phase

2.3. Detailed Design

At this phase the 3D model, the CAE analysis and the analytical dimensioning are made. Also all materials to be used on each part are selected, as well as the specifications for the commercial components are defined.

Since one of the main design premises was the low manufacturing cost of the machine, the material selection focused on common materials. The main material used on the milling machine is aluminum, because of its great weight-cost ratio. It's used specially for the moving parts, since with lower weight they will have less inertia and the motors needed to move them will consume less power.

Some parts of the machine were chosen to be analytic dimensioned. It started with the cutting force because it's the main dynamic force acting during the machining. The model used is the one presented by Schmitz and Smith (2008). The cutting force has a cyclic nature and the maximum cutting force found was 14,25 N. The spindle works at around 25.000 rpm which is a very high velocity and its axis could enter into a state of resonance. To find the axis critical speed the mathematical model used is proposed by Budybas and Nisbett (2006). This method needs the static deformation of the axis with all masses attached to it. To find these deformations the Castigliano's theorem was used. The critical speed obtained by this method was 155.000 rpm, so no resonance should occur because the operation speed of the spindle is six times lower. Since the cutting force will be transmitted directly to the spindle axis and this force doesn't have a constant direction, the axis could fail by fatigue. To dimension it to an infinite life on fatigue, the model proposed by Budinas and Nisbett (2006) was used. Some other cases should be dimensioned using CAE analysis because the interaction between parts affects the results and how forces are transmitted. All the linear guides were dimensioned this way, because if they deflect too much, the amount of material removed from the PCB will not be uniform. CAE was also used on the sliding bushings, which could lock if they deform too much, since they have no bearings to help the movements. The results showed that the worst case happens on the lower guides, which support all moving parts. They deflect 0,042 mm, which is only 0,25% of the copper's thickness that must be removed. The bushings deform 1,76e-5 mm, which is insignificant compared to the minimum clearance specified between the shafts and the bushings: 25,00e-3 mm. Other analyses were made but these two were the most critical.

The final design can be seen at Figure 8.

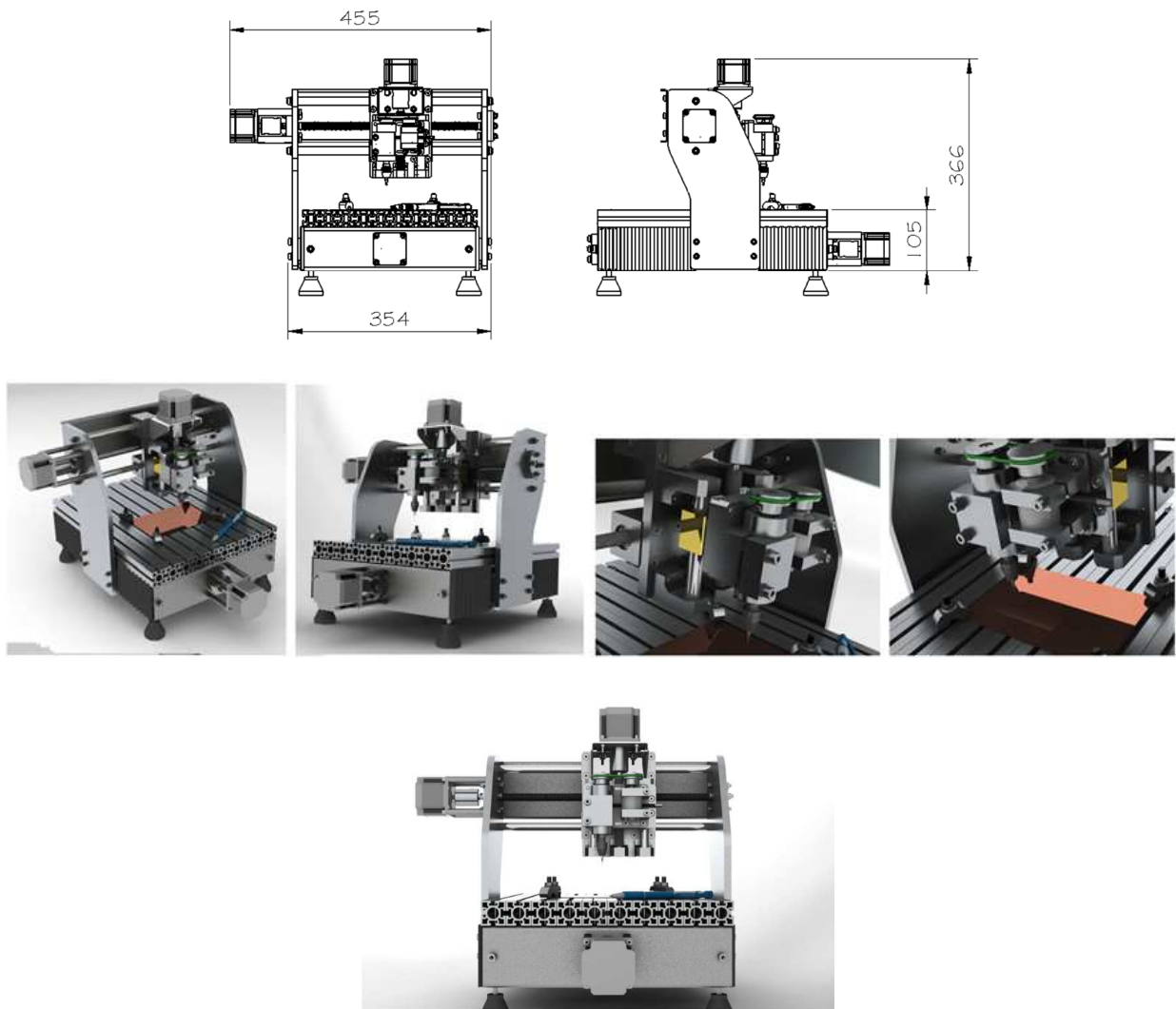


Figure 8. CNC milling machine final design

2.4. Manufacturing and Assembly

All parts were detailed and sent to manufacturing. At the end, the costs associated with the prototype were US 2.050,00, that is, 21,8% of the acquisition cost of the machines analyzed at Fig. 2.

The Figure 9 shows some assembly stages and the prototype fully assembled, but without the electronic components yet.

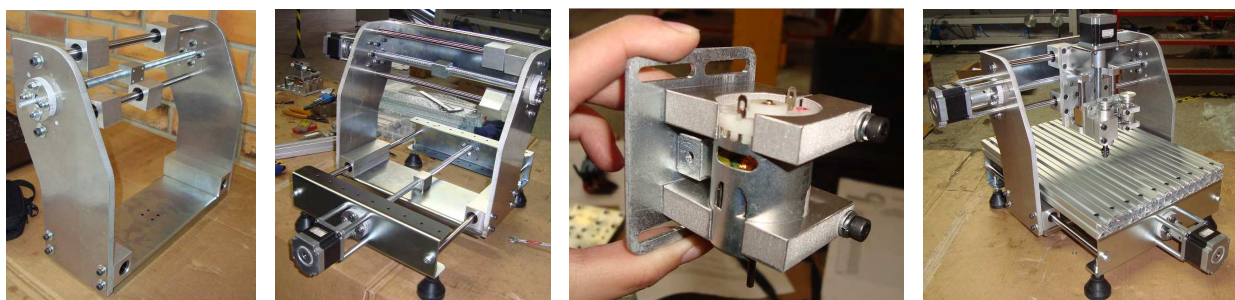


Figure 9. Prototype assembly stages

2.4. Testing and validation

The first tests made were on the belt transmission and the pressure joint used between the motor shaft and its pulley. It was analytic dimensioned to work without slipping. Two aligned marks were made on the shaft and on the pulley to see if any slipping would occur when the machine is running. Figure 10 shows these marks and the transmission running. It worked for about one hour and the inspection after that showed that there were no slipping between the shaft and the pulley. The belt transmission was chosen because if the tool were attached directly to the motor, the motor vibration could interfere with the machining, making PCBs' dimensions less precise. This type of transmission absorbs the vibration and the tool runs smoother. While the machine was running, it was clearly seen that the motor vibrates, but the tool assembly doesn't.



Figure 10. Marks made on shaft and pulley to check for slipping

Repeatability tests were made as well. Its objective is check if the machine stops exactly at the same position after some cycles. A precision dial gauge was attached to the machine and it was commanded to move one axis for a determined distance and then go back. This cycle is repeated 15 times for each test. The test is repeated 10 times for each axis. These tests were done with the axis moving a total distance of 1500 mm, 3000 mm and 6000 mm. The results lied around +0,01 mm and -0,01 mm every time, which reflects in a problem with the repeatability of the instrument itself, otherwise this error would be cumulative as the traveled distances increased. Figure 11 shows how the precision dial gauge was attached to the machine for each axis' test. Table 1 shows the measured offsets at the end of each test.



Figure 11. Product Development Process

Table 1. Measured offsets obtained from the repeatability tests

1500 mm test	Axis			3000 mm test	Axis			6000 mm test	Axis		
	X	Y	Z		X	Y	Z		X	Y	Z
1	0,01	0,01	0,00	1	0,00	0,00	0,01	1	0,01	-0,01	0,00
2	0,01	0,00	0,00	2	0,00	-0,01	-0,01	2	0,00	0,00	0,00
3	-0,01	0,01	0,00	3	0,01	-0,01	-0,01	3	0,00	0,01	0,01
4	0,01	-0,01	0,00	4	0,01	0,00	0,01	4	0,01	-0,01	0,00
5	0,00	-0,01	-0,01	5	0,00	-0,01	-0,01	5	-0,01	-0,01	0,01
6	0,01	-0,01	-0,01	6	-0,01	0,00	-0,01	6	0,01	-0,01	0,00
7	-0,01	0,01	0,01	7	-0,01	0,01	0,00	7	0,01	0,00	0,00
8	0,01	0,00	0,01	8	0,00	0,00	-0,01	8	0,00	0,00	0,00
9	0,00	0,01	0,00	9	0,01	-0,01	0,01	9	0,00	0,00	0,01
10	0,01	0,00	0,01	10	0,01	-0,01	0,00	10	0,00	0,01	-0,01

The tracks on the PCBs may have the thickness as low as 0,1 mm. The machine must be able to make such tracks. To check this, many tracks were made on a PCB to see how thin the tracks that the machine could make were. Then these PCBs were measured using a profile projector. Figure 12 shows the PCBs being measured. Some problems were experienced here. One is caused by the PCB itself, together with the type of tool used. The tool has a V shape, and because of this the machining diameter varies along the depth of the machining. This should not be a big deal if the PCB was perfectly plain, which it's not. For each 0,1 mm of depth, the machining diameter varies 0,035 mm, changing how much material is removed and affecting the tracks' thickness. For thicker tracks it's not noticeable, but for the thinner ones this may be a problem. Also, the tool holder is a commercial component and was not designed with the machine. It's made for hand jobs and not for this kind of work. It's not precision made and can't hold the tool exactly concentric and aligned with the shaft. This also affects the tracks' effective thickness. The samples tracks made for this test had thickness ranging from 0,1 mm to 1,00 mm. Table 2 shows the measuring obtained from the 0,1 mm samples. The mean minimum thickness found was 0,89 mm, less than the minimum planned, but since the tool can't be exactly aligned with the shaft, it sometimes broke the thinnest tracks. Suggested minimum thickness for this machine is 0,15 mm because on these tests there weren't any broken tracks.

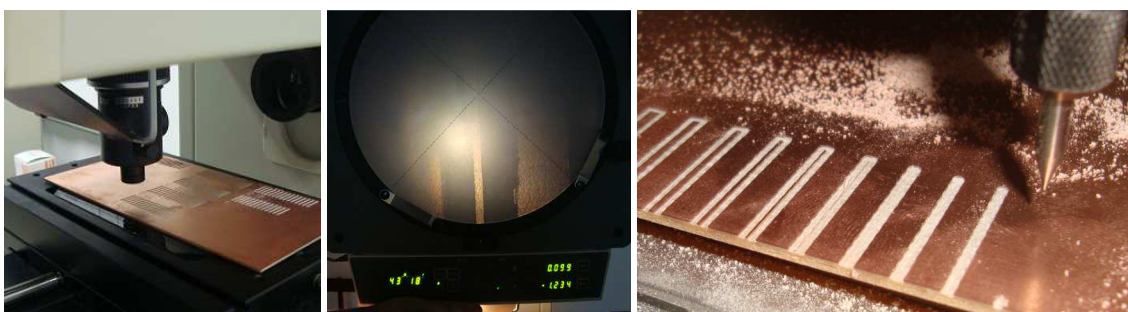


Figure 12. Sample tracks being measured with a profile projector

After all these tests some real PCBs were made to see how the machine performed on real cases. Figure 13 shows some of these PCBs.

Table 2. Measured thickness for the 0,1 mm sample tracks

Test 1 - 0,10 mm		Test 2 - 0,10 mm		Test 3 - 0,10 mm	
Track	Value	Track	Value	Track	Value
1	0,088	1	0,089	1	0,088
2	0,095	2	0,097	2	0,085
3	0,094	3	0,087	3	0,095
4	0,085	4	0,088	4	0,091
5	0,089	5	0,085	5	0,089
6	0,090	6	0,092	6	0,090
7	0,089	7	0,089	7	0,088
8	0,088	8	0,096	8	0,095
9	0,077	9	0,095	9	0,088
10	0,091	10	0,091	10	0,077

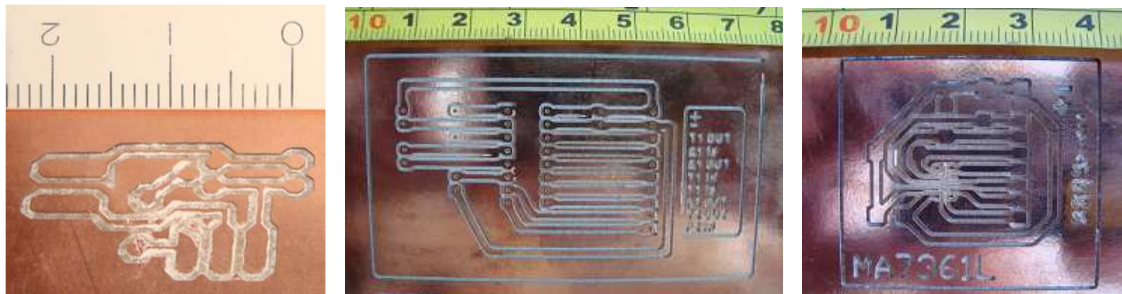


Figure 13. PCBs made with the CNC milling machine presented on this paper

3. CONCLUSION

By using the methodology described in this paper it was possible to develop a product that meets all requirements needed by the interviewed customers. Besides that, the product also has the main characteristics of the analyzed competitors, but with a much lower cost.

Even using simple metric threaded bars, without precision machinery, high levels of repeatability were acquired. This gave the product the ability to make very thin tracks, in the order of tenths of millimeters. These thin tracks are essential when making PCBs for surface mounted components, which are very small.

The main problem was the tool holder, which can't hold the tool concentric to the spindle axis. Even with the small misalignments found, some problems like the rupture of very thin tracks can happen.

Besides changing the tool to one with cylindrical shape, to improve the precision of tracks' thickness, the tool holder is the main improvement that can be made to turn this machine on a product that could really compete in the market.

4. REFERENCES

- Basniak, R. et al., 2010. "Desenvolvimento de uma fresadora CNC para placas de circuito impresso". Curitiba: Positivo University.
- Booker, J. D. and Raines, M.; Swift, K. G., 2001. "Designing capable and reliable products". Massachusetts: Elsevier Butterworth-Heinemann.
- Budynas, R. and Nisbett, J. K., 2006. "Shigley's mechanical engineering design". 8th ed. New York: McGraw Hill.
- Rozenfeld, H. et al., 2006. "Gestão de desenvolvimento de produtos". São Paulo: Editora Saraiva.
- Schmitz, T. L. and Smith, K S., 2008. "Machining dynamics". Great Britain: Springer-Verlag London Limited.

5. RESPONSIBILITY NOTICE

The authors are the only responsible for the printed material included in this paper.