

DEVELOPMENT OF DENSIMETER USING BELLOWS

Eduardo Pereira Motta, edupmotta@msn.com¹
Kletson Vieira da Silva, kletsoneng@hotmail.com¹
Henrique Pereira Motta, maranhaum@hotmail.com¹
Gúbio Soares Saldanha, gubioengmec@hotmail.com¹
Filipe Dumaresq de Oliveira Montenegro, filiped85@hotmail.com¹
Luis Henrique Pinheiro de Lima, henriquengmec@ufrnet.br¹
Luiz Pedro de Araújo, lpedro@dem.ufrn.br¹
Walter Link, walter_link@uol.com.br¹

¹Universidade Federal do Rio Grande do Norte, Av. Senador Salgado Filho, 3000, CEP: 59078-970, Natal-RN.

Abstract. *Given the wide use of densimeter in metrology, this paper aims to develop a device using the pressure for measuring density of liquids. Due to the great usage of this property, for example, in the petrochemical industry, there is a need to develop an instrument that is accurate, easy to use and that can collect more accurate values for this property of substances. It differs from the usual systems, because it operates without the necessity to use a reference material for its calibration. It works by following the principle of hydrostatic, considering the difference in pressure generated by the difference in the height of the fluid. It consists of an polyethylene tube which will be fixed at a height known (calibrated), two displacement sensors and bellows. The development will be done in four steps: 1) Literature Review, 2) Design and Construction, 3) Testing, 4) Evaluation of the density measurement system with its determination of the uncertainty. With this project, the metrology laboratory at UFRN will have another tool to be used in the measurement of densities.*

Keywords: *Densimeter, optimization, bellows, Hydrostatic, Diaphragm.*

1. INTRODUCTION

Calibration is an experimental procedure which relations are established between the values indicated by a measuring instrument and the corresponding values of the quantities set by standards. Even though the characteristics of the measurement system are very good, it will always present some kind of error, provided by internal factors or by action of external influence quantities. A complete description of the uncertainties associated with these errors has a great importance so that the measurement result can be estimated safely.

The magnitude density also suffers from errors since it is defined as a specific property, in others words, each pure substance has a density itself that identifies and differentiates it from other substances, the absolute density of a substance is defined as the ratio between its mass and its volume:

$$d = \frac{m}{v} \quad (1)$$

Where:

d = absolute density;

m = mass of the substance;

v = volume occupied by the substance.

The relative density of a material is the ratio of its absolute density and the absolute density of a substance established as standard. In the calculus of the relative density of solids and liquids, the standard usually chosen is the absolute density of the water, which is equal to 1.000 kg dm⁻³ (equivalent to 1.000g cm⁻³) at 4°C, given by:

$$d = \frac{\rho}{\rho^{\omega}} \quad (2)$$

Where:

$\rho^{\omega} = \rho(H_2O, 4^{\circ}C)$

ρ = absolute density of the fluid

d = relative density

The density varies periodically with the atomic number, but these variations are not regular, since the relation with the physical and electronic configuration is not straightforward.

A possible variation in the value of the density of substances is the fact that most of the solids and liquids expands slightly when heated and contract slightly when cooled, causing variations almost imperceptible in density. For gases, however, the temperature exerts a great influence on the values of density, since this factor contributes to a further expansion or compression of gas. This property is used in many situations, one is the determination of the hydrostatic pressure, since hydrostatic pressure is directly proportional to density, gravity, height of a fluid and air pressure:

$$P_h = \rho gh + P_o \tag{3}$$

Where:

P_h = hydrostatic pressure

ρ = density of the fluid

g = acceleration of the gravity

h = height

P_o = atmospheric pressure

2. METODOLOGY

2.1. The Archimedes principle

Nowadays, the method used for determination of density is based on the principle of buoyancy discovered by Archimedes, where an object that is partially or completely submerged in the fluid, suffer a thrust force equal to the weight of the fluid that the object displaces.

$$F_e = W_{fluid} = r_{fluid} \cdot V_{displaced} \cdot g \tag{4}$$

The buoyant force, F_e , applied by the fluid on an object is directed upwards. The force is due to the difference pressure on the bottom and top of the object. For a floating object, the part that is above the surface is under atmospheric pressure, while the part that is below the surface is under a higher pressure because it is in contact with a greater depth of the fluid, and the pressure increases with depth. To an object completely submerged, the top of this object is not under atmospheric pressure (Figure 1), but the bottom is still under a further pressure because the fluid is deeper (Figure 2). In both cases the difference in pressure results in a resulting force upward (buoyant force) on the object. This force must be equal to the weight of mass water ($r_{fluid} \cdot V_{displaced}$) shifted, as if the object does not occupy that space that would be the force applied to the fluid within that volume ($V_{displaced}$) so that the fluid was in equilibrium.

The determination of density using this method is as follows:

- Sphere immersed in air

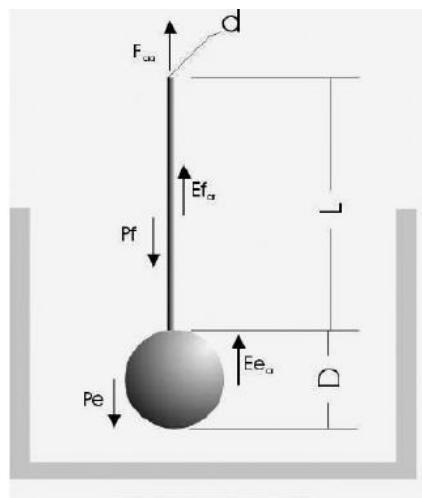

Figure 1 – Free body diagram of a sphere immersed in air

$$F_{aa} \cong m_{apparent_{air}} \cdot g - \left(\frac{\rho_{air}}{\rho_s} \right) m_{apparent_{air}} \cdot g \tag{5}$$

$$F_{aa} = \left(1 - \frac{\rho_{air}}{\rho_s}\right) m_{apparent_{air}} \cdot g = \phi \cdot m_{apparent_{air}} \cdot g \quad (6)$$

$$F_{aa} + E_{f_{air}} + E_{e_{air}} = P_f + P_e \quad (7)$$

$$\phi \cdot m_{apparent_{air}} + \rho_{air} \cdot A_f \cdot L + \rho_{air} \cdot V_e = m_f + m_e \quad (8)$$

- Sphere immersed in liquid

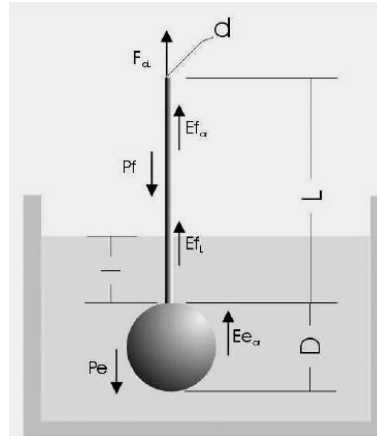

Figure 2 – free body diagram of a sphere immersed in liquid

$$F_{a_l} + E_{f_{air}} + E_{f_{al}} + E_{e_{air}} = P_f + P_e \quad (9)$$

$$\phi \cdot m_{apparent} + \rho_{air} \cdot A_f \cdot (L - I) + \rho_l \cdot (A_f \cdot I + V_e) = m_f + m_e \quad (10)$$

$$\rho_l = \left(1 - \frac{\rho_{air}}{\rho_s}\right) \cdot \left(\frac{m_{apparent_{air}} + m_{apparent_L}}{\left(\frac{\pi}{4} \cdot d^2 \cdot L + V_e\right)}\right) + \rho_{air} \quad (11)$$

Where:

- $m_{apparent_{air}}$ - apparent mass of the sphere suspended in air
- $m_{apparent_L}$ - apparent mass of the sphere suspended in liquid
- m_e - mass of the sphere
- m_f - mass of the wire
- F_{aa} - force exerted to keep the system in balance air
- $E_{e_{air}}$ - buoyancy of the air on the sphere
- E_{e_l} - buoyancy of the liquid on the sphere
- E_{f_l} - buoyancy of the liquid over the wire immersed in liquid
- $E_{f_{air}}$ - buoyancy of air over the wire above the liquid
- A_f - cross-sectional area of wire
- L - total length of wire
- I - length of the immersed wire
- V_e - volume of the sphere
- ρ_{air} - air density
- ρ_l - liquid density
- ρ_s - density of the internal weights of the balance (approximately 8000kg/m³)
- ϕ - correction factor ($\phi = 1 - (\rho_{air}/\rho_s)$)
- g - acceleration of gravity
- u_x - standard uncertainty of variable x

Thus it becomes possible to determine the density using the Archimedes method.

2.2. Hydrostatic pressure

It is the pressure exerted by the weight of a fluid column in balance. Because it describes a pressure, this weight force is given in a certain area. As the figure 3 shown below:

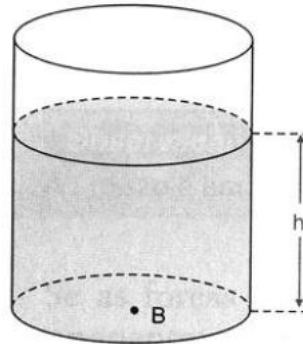

Figure 3

$$P_h = \frac{F_p}{A} \text{ as } F_p = mg, \text{ we have:} \quad (12)$$

$$P_h = \frac{mg}{A} \text{ as } m = d.V, \text{ we have:} \quad (13)$$

$$P_h = \frac{d.V.g}{A}, \text{ but } V = A.h \text{ so,} \quad (14)$$

$$P_h = d.g.h \quad (15)$$

As this pressure is effective, one must also consider the atmospheric pressure, so the hydrostatic pressure can be described as shown below:

$$P_h = d.g.h + P_{atm} \quad (16)$$

2.3. Description of the hydrometer using the principle of hydrostatic pressure

This densimeter solves the problem of performing an intercomparison between the density measurement following the Archimedes' principle. Its mechanism is simple but very efficient, consists of a polyethylene cylinder (Figure 4a), and two bellows (Figure 4b) for measure the pressure of two points: one in the base of the cylinder and another in the top.

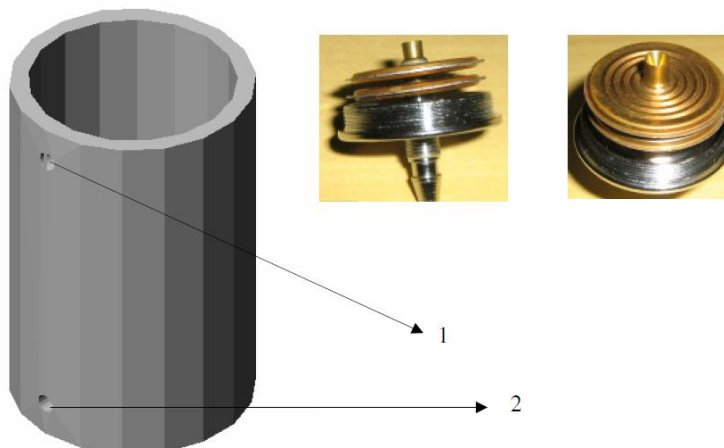

Figure 4(a): description of the densimeter Figure 4(b): the bellows used

These bellows are inserter in 1 and 2 in order to realize the measurement of the pressure. The bellows are instruments widely used in mechanical aneroid sphygmomanometers. These devices operate by elasticity of foil, since

when the pressure is sent to the bellows, its expands and moves the tube. Its displacement is transmitted to the displacement sensor, which through its compression to the pointer in order to traverses the scale indicating the amount of pressure (Figure 5).

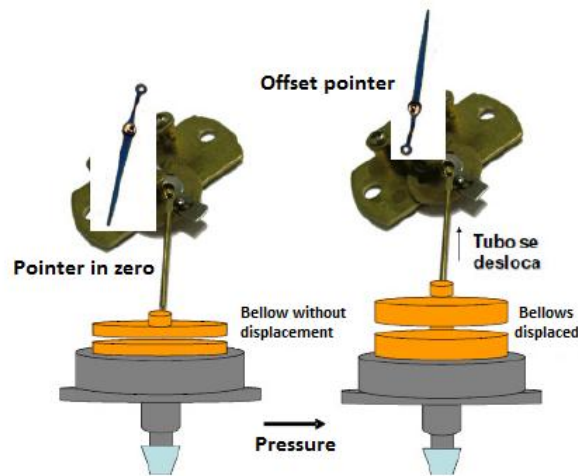

Figure 5 – the system build with the bellows

When reading the measurement of the two pressures, we use the difference between then and those distance to determine the density of the fluid.

$$\Delta P = \rho gh \tag{17}$$

$$\rho = \Delta P / gh \tag{18}$$

Where g is the local gravity, d is the displacement between the bellows and ΔP the variation of the measured pressure.

3. EXPERIMENT

3.1. Relation between the displacement of the bellows and the pressure using water and alcohol

Unfortunately, we had trouble finding two displacement sensors for this experiment, so we had to measure the relative density between two fluids. Therefore, in order to calculate the relative density between alcohol and water, we must develop the relation between the displacement of the bellows and the pressure of both fluids. That is why a bench was built for the experiment composed by a vertical caliper, a bellow (Figure 7), a polyethylene cylinder of 500ml and displacement sensor (Figure 6).



Figure 6 – The bench

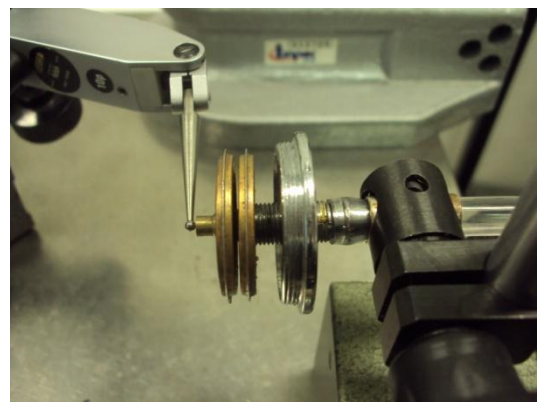

Figure 7 – The bellows and the displacement sensor

The increase of the pressure was registered by the displacement sensor. There was made three experiments with two different fluids, water and alcohol. The experiment was made in a standard whose the temperature was 21,7°C and the relative humidity was 61%. The average and the standard deviation data of the relation between the pressure and the displacement is shown on the table 1 below:

Table 1 – Experimental results for the displacement of the bellows and their standard deviation

Pressure(mm)	Average of the Displacement(μm)		Standard deviation	
	Water	Alcohol	Water	Alcohol
56	17	11	0.00	3.51
112	40	29	1.00	4.00
168	63	43	2.81	1.15
224	86	59	2.00	2.08
280	104	77	1.73	1.15

After take all the data, a diagram was built based on the table shown behind:

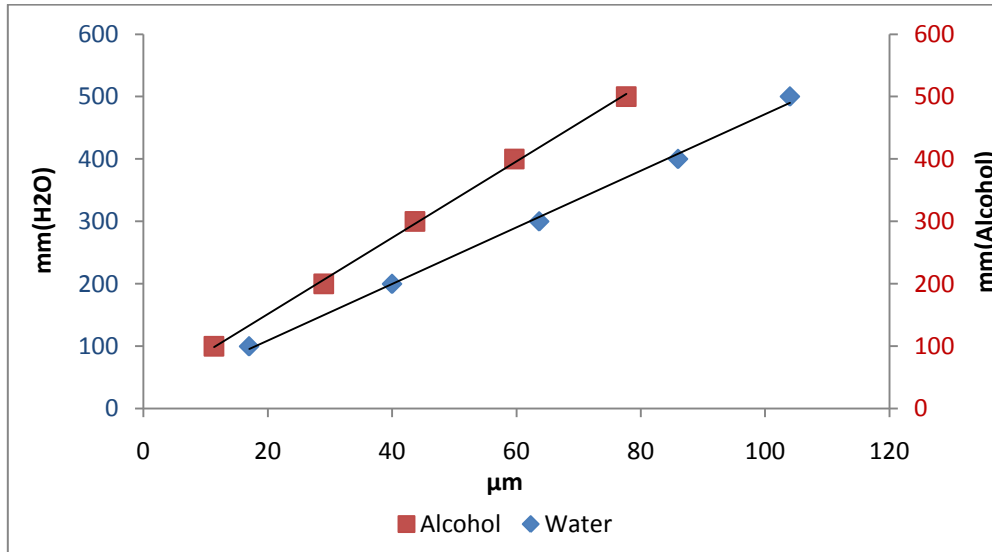

Figure 8 – Diagram of pressure and displacement of the bellows

The software that was used to take all the data and plot the diagram has also build an equation that represent the relation between the pressure and the displacement of both bellows. This relation is shown below with their respective errors:

Water:

$$dP_{B1} = 2.539D_{B1} + 10.223 \text{ with } R^2 = 0.9976 \tag{17}$$

Alcohol:

$$dP_{B2} = 3.424D_{B2} + 16.398 \text{ with } R^2 = 0.9989 \tag{18}$$

3.2. Calculating the relative density of alcohol

We already know the relation between the pressure and the displacement of both fluids, therefore we must solve the equations above to find the pressure constants of the two fluids in the system build. Deriving the equations (17) and (18), we have:

$$K_{\text{water}} = 2.529 \tag{19}$$

$$K_{\text{alcohol}} = 3.424 \tag{20}$$

Thus, we can calculate the relative density of the alcohol:

$$\rho_{r.\text{alcohol}} = \frac{2.529}{3.424} = 0.74 \tag{21}$$

3.3. Measurement uncertainty

The uncertainty of our experimental result is very important, because with it we can analyze the reliability of the relative density obtained. Thus, one can check if the finding results was consistent, and if it is worthwhile to use this method to calculate this variable in question.

Several factors must be analyzed in order to calculate the uncertainty of our measurement. With the change of temperature and pressure and relative humidity, there is a dilation of the fluid. It interferes significantly in the manipulation of results.

The individual analysis of the operator must be studied. Because each person has a different motor coordination and variable vision. Thus, the cylinder was filled several times, so there were a high risk of parallax error. That's happens because each time that the cylinder was filled, the operator probably has analyzed the scale in a different angle, resulting in the change of the volume of fluid that fills the cylinder with consequent pressure variation.

The meniscus formed by the fluid also have a vital influence on the results. That is because its dimensions fit in various divisions of the cylinder. Thus, each time the operator could manipulate the cylinder, he filled it with different volumes, altering the pressure obtained by the bellows, so influencing the relative density calculated.

Therefore, when making the quadratic sum of each uncertainty obtained using the variables studied, one finds the total uncertainty of the relative density calculated. On the table 2, the uncertainty of each point is showed.

Table 2 – measurement uncertainty of each point of the cylinder

Points of the cylinder (mm)	Uncertainty
56	± 0.026; k = 2.869
112	± 0.036; k = 3.306
168	± 0.012; k = 2.035
224	± 0.016; k = 2.231
280	± 0.013; k = 2.035

3.4. Comparing results

Now that we had calculated the relative density of the alcohol from our experiment, we must compare this result to another using others kinds of measure. According to the book Introduction to fluid Mechanics; from Robert W. Fox, Alan T. Macdonald and Philip J. Pritchard; the relative density of alcohol in a temperature of 4°C is :

$$\rho_{\text{alcohol}} = 0.789 \tag{22}$$

It is clear that there is an error of approximately 6.3%. However, another kind of measure has been made, and it is consists from calculating the relative weight between the fluids. Then, a bench was made using a precision balance (Figure 9) and two bottle (Figure 10), one containing alcohol and other containing water as the image shows below:



Figures 9 and 10, a precision balance and a bottle

First of all, we weighed the bottle. After that, we measure the weight of the bottle containing water and alcohol. The results are in the table 3 below:

Table 3 – Experimental results of the weights

Weight of the bottle	Weight of the bottle with alcohol	Weight of the bottle with water
20.7561g	67,3142g	78,3706g

Therefore, now we can calculate the relative density of the alcohol, using a simple equation:

$$\rho_{alcohol} = \frac{67.3142 - 20.7561}{78.3706 - 20.7561} \quad (23)$$

$$\rho_{alcohol} = 0.808 \quad (24)$$

Again, it is clear that there is an error of approximately 8.4%.

4. DISCUSSION OF THE RESULTS

For the precise measurement science, both errors (6.3% and 8.4%) are unacceptable. So, our experiment have a lot of different kinds of errors. From the table 1, it is possible to note that the standards deviations are very dispersed. So, it must be one of the main reasons why the errors are so big.

However, this dispersion of the standard deviation must have a reason. The data from the experiment on table one were widely dispersed too. That is why the standards deviation are so large.

To avoid all these dispersion in the measurement, the bellows should be better fixed in the cylinder. In the other hand, the displacement sensor must not have mechanical contact with the bellows. That would avoid that the pressure of the displacement sensor in the bellows intervened the measurement.

Thus, the ideal experiment should be made welding the bellows in the cylinder and using another kind of displacement sensor, one that don't have physical contact with the bellows, like a magnetic one.

5. CONCLUSIONS

The need for an incessant quest to improve the measurement system emphasizes the idea that every time that you spend to minimize errors is paramount. We believe that the measurement system with two bellows and two displacement sensor, that do not have physical contact with the bellows, can yield results with low uncertainties. Although, it is only possible with a better temperature control and positioning of the samples. With this system you can prepare reference materials for specific gravity of liquids, able to provide traceability for the most current tools for measuring property.

6. ACKNOWLEDGEMENTS

We thank the entire team LabMetrol, especially the professors Walter Link and Luiz Pedro in building the project.

7. REFERENCES

- ABNT – Associação Brasileira de Normas Técnicas. *NBR 5995*. Determinação da massa específica e do teor alcoólico do álcool etílico e suas misturas com água. Rio de Janeiro, 1980.
 FOX e McDonald, 2001, Introduction to fluid Mechanics, 5ª ed. Rio de Janeiro: Guanabara Dois.
 M. White, FRANK, 1998, Fluid Mechanics, Fourth Edición. University of Rhode Island – Kingston.
 De Souza Themudo, Juliana e Rezende Zucchini, Ricardo. *Projeções*, v. 23, p. 7-12, jan/dez 2005. Desenvolvimento de método de medição de massa específica pelo princípio de Arquimedes.
 Vocabulário Internacional de Termos Fundamentais e Gerais de Metrologia – VIM.

8. RESPONSIBILITY NOTICE

The author(s) is (are) the only responsible for the printed material included in this paper.