

DYNAMIC MODELING OF A HIGH SPEED TROLLEY FOR TV TRANSMISSION

Vitor Ferreira Romano

Federal University of Rio de Janeiro – Poli/UFRJ, Mechanical Eng. Department, Robotics Laboratory
Cidade Universitária – CT, Bloco G-204 - 21945-970 Rio de Janeiro - RJ - Brazil
romano@mecanica.coppe.ufrj.br

Eugênia Cruz da Trindade

MSc. Candidate
Federal of Rio de Janeiro – COPPE/UFRJ, Mechanical Eng. Department, Robotics Laboratory
Cidade Universitária-CT, Bloco G-204 - 21945-970 Rio de Janeiro - RJ – Brazil
etrindade@ufrj.br

Abstract. *This article presents the dynamic modeling and simulations of a high speed camera trolley system to be used for TV transmission of 100 meters athletics race. The proposed prototype consists on a wheeled trolley moving along a binary linear track fixed on the floor, designed to carry TV equipment onboard, such as the pan-tilt remote head with a focus-zoom control and camera, control unit, power unit, transmission unit and battery packs. A previous project of a low speed telerobotic camera trolley system was developed in 2002 to generate TV images with different and special view angles of the “samba school” parade in Rio de Janeiro Carnival. The main design parameters used in the actual model are based on the previous low speed system. The 2D mathematical modeling of the camera trolley system dynamics and its state-space modeling are described in this paper. Some results of the simulations such as graphics and commentaries are also presented.*

Keywords: *cine-video equipment, dynamic modeling, telerobotics, mechatronics*

1. Introduction

Sport events like Pan-American and Olympic Games are among the most important ones for the broadcast industry. The television networks transmit different and very complex images of the various sports to millions of people worldwide. Athletics represents the millenary tradition of these Games and undoubtedly is the most watched sport competition on TV.

In order to obtain detailed images with exclusive and special view angles, without loss of quality, TV networks are always demanding for sophisticated equipments. This is the case of 100 m split athletics race, where low height images of the runners feature special scenes of the competition. Equipments consisting on a wheeled trolley moving along a binary linear track with a pan-tilt camera device onboard have been frequently used to generate these images.

For a good quality image generation it is mandatory that the camera trolley system provides acceptable range values of external perturbations, such as linear and angular mechanical vibrations due to binary track geometrical discontinuities. Other important design aspects are related to uncertainties due to the installation of the track mounting parts and structural stiffness of the whole system formed by the trolley, the binary track and floor.

A previous project of a low speed telerobotic camera trolley system was developed in 2002 to generate TV images of the “samba school” parade in Rio de Janeiro Carnival. In this project the maximum controlled velocity of the trolley was 2.3 m/s. In the actual high speed model, the maximum controlled velocity of the trolley is defined to be 12 m/s, compatible to the world record of 9.79 m/s of average speed for the 100 m sprint. The main design parameters used in the actual model are based on the previous low speed system, as presented in Tab. 1.

Table 1. Parameters from Carnival 2002 camera trolley system (Romano and Ferreira 2003).

total mass (including onboard equipment)	60 Kg
trolley dimension	1210mm x 350 mm x 150 mm

2. Dynamic model

2.1. Dynamic equations

The trolley system moves back and forth along the tracks, therefore the stability of TV images generated during its alternate motion depends on the induced dynamic payload conditions from the interaction between wheels and binary tracks (Romano and Trindade, 2004). The dynamic analysis of this interaction is of fundamental importance to indicate to the design team the best solution to be adopted in the future prototype. A 2D dynamic model of the trolley is shown in Fig. 1.

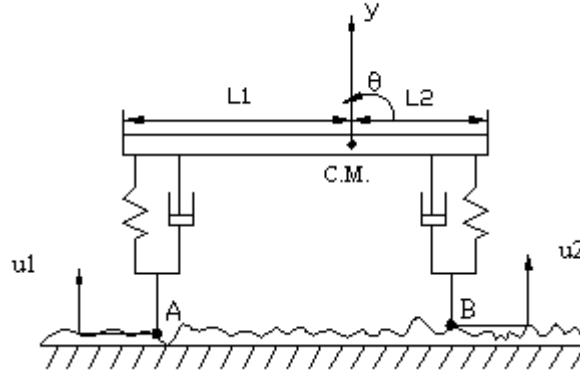

Figure 1. 2D dynamic model.

When the trolley system moves along the tracks the vertical displacements of the wheels (points A and B) act as the system excitation input parameters.

These displacements are mainly due to surface irregularities such as ovalization and roughness and the space for thermal expansion at the tracks. In Fig. 1 they are indicated as u_1 e u_2 .

The output data of the 2D model consist on a translation of the center of mass (C.M.) and a rotation around this point, given by y_c and θ_c respectively. The dynamic equation of the model is:

$$\begin{bmatrix} M & 0 \\ 0 & J \end{bmatrix} \begin{bmatrix} \ddot{y} \\ \ddot{\theta} \end{bmatrix} + \begin{bmatrix} 2C & -C(L_1-L_2) \\ -C(L_1-L_2) & C(L_1^2-L_2^2) \end{bmatrix} \begin{bmatrix} \dot{y} \\ \dot{\theta} \end{bmatrix} + \begin{bmatrix} 2K & -K(L_1-L_2) \\ -K(L_1-L_2) & K(L_1^2-L_2^2) \end{bmatrix} \begin{bmatrix} y \\ \theta \end{bmatrix} = \begin{bmatrix} 0 \\ 0 \end{bmatrix} \quad (1)$$

Where

- C: damping coefficient
- J: moment inertia
- K: rigidity coefficient
- M: mass

2.2. State space equations

The trolley dynamic model is a multivariable system, so that state space equations can be used to describe its behavior. The state differential and the output equations are described in Eq. (2) and Eq. (3) (Dorf, and Bishop, 2001).

$$\dot{x}(t) = Ax(t) + Bu(t) \quad (2)$$

$$y(t) = Cx(t) + Du(t) \quad (3)$$

So, the mathematical model for the trolley in matrix form is:

$$\dot{x}(t) = \begin{bmatrix} 0 & 1 & 0 & 0 \\ -\frac{2K}{M} & -\frac{2C}{M} & \frac{K(L_1-L_2)}{M} & -\frac{C(L_1-L_2)}{M} \\ 0 & 0 & 0 & 1 \\ \frac{K(L_1-L_2)}{I} & \frac{C(L_1-L_2)}{I} & -\frac{K(L_1^2-L_2^2)}{I} & -\frac{C(L_1^2-L_2^2)}{I} \end{bmatrix} x(t) + \begin{bmatrix} \frac{C}{M} & \frac{C}{M} \\ \left(\frac{2C^2}{M^2} + \frac{C^2 L_1(L_1-L_2)}{M I} + \frac{K}{M} \right) & \left(\frac{2C^2}{M^2} + \frac{C^2 L_2(L_1-L_2)}{M I} + \frac{K}{M} \right) \\ \frac{C L_1}{I} & \frac{C L_2}{I} \\ \left(\frac{-C^2(L_1-L_2)}{M I} - \frac{C^2 L_1(L_1^2-L_2^2)}{I^2} + \frac{K L_1}{I} \right) & \left(\frac{C^2(L_1-L_2)}{M I} - \frac{C^2 L_2(L_1^2-L_2^2)}{I^2} + \frac{K L_2}{I} \right) \end{bmatrix} u(t) \quad (4)$$

And

$$\begin{bmatrix} y(t) \\ \theta(t) \end{bmatrix} = \begin{bmatrix} 1 & 0 & 0 & 0 \\ 0 & 0 & 1 & 0 \end{bmatrix} x(t) + \begin{bmatrix} 0 & 0 \\ 0 & 0 \end{bmatrix} u(t) \quad (5)$$

3. Model simulation

3.1. Introduction

To simulate the trolley dynamic model it is necessary to define the numerical values of the parameters related to the model.

3.2. Excitation function (input data)

The system is influenced by two main excitation input functions: the fluctuation of displacements due to surface irregularities and the existing space at the tracks for thermal expansion.

3.2.1. Tube and track interface

The main components of the binary tracks are commercial tubes that are successively connected to the track supports. During summer the temperature of the tracks can change from 15°C to 60°C (Romano, 2002), therefore a special fixture device was conceived to separate appropriately the tube and track support interfaces, so that the necessary thermal expansion could occur. Fig. 2 shows how the connection is made.

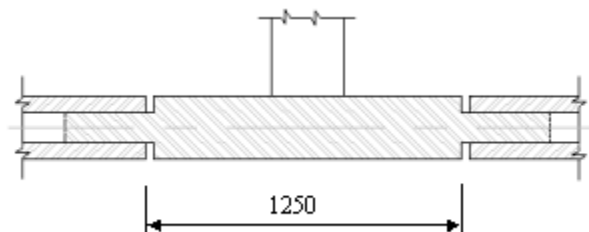

Figure 2. Tube mounting at a track support.

Each time one of the trolley wheels passes through the interface, a perturbation is generated due to a local vertical impulse created at the trolley. So, this excitation function can be modeled as the sum of two pulse trains with the same period, same amplitude, and an appropriate time delay.

To discover the amplitude value, it is necessary to discover the changes length when occur changes in temperature. The calculation is set up as (Beitz and Küttner, 1994):

$$\delta L = \alpha \cdot L \cdot \delta T \quad (6)$$

Where

- δL : Change in length [m]
- α : Coefficient of linear expansion [1/°C]
- δT : Change in Temperature [°C]
- L: Length [m]

The tracks are steel made, so that $\alpha = 1.17 \times 10^{-5}$ 1/°C. The distance between a track support and tubes is $L = 1250$ mm, and the considered temperature range is $\delta T = 45$ °C.

The calculated length change is $\delta L = 0.66$ mm. A space of 2.0 mm was chosen to guarantee the necessary separation of the parts.

The amplitude of the vertical motion of the camera trolley system, due to the passage of the wheel in the 2.0 mm space (impact neglected) can be geometrically calculated by the analysis of the triangle OBC, defined in fig. 3. In this case, \overline{OB} is the wheel radius, \overline{BC} represents the half value of the space between the tube and the track support interface and the parameter A is the motion amplitude.

By Pythagoras theorem, the calculated amplitude is 0.014 mm.

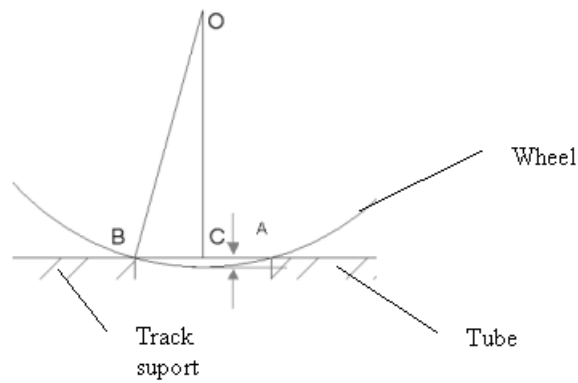

Figure 3. Wheel, tube and track geometrical relations.

3.2.2. Surface waviness

The estimation of the surface waviness was obtained by measuring a track tube sample, used in the previous project, with a calibrated measuring instrument, Bendix BX model 21, able to acquire the contour of the sample. Fig. 4 presents the surface profile used in the simulation.

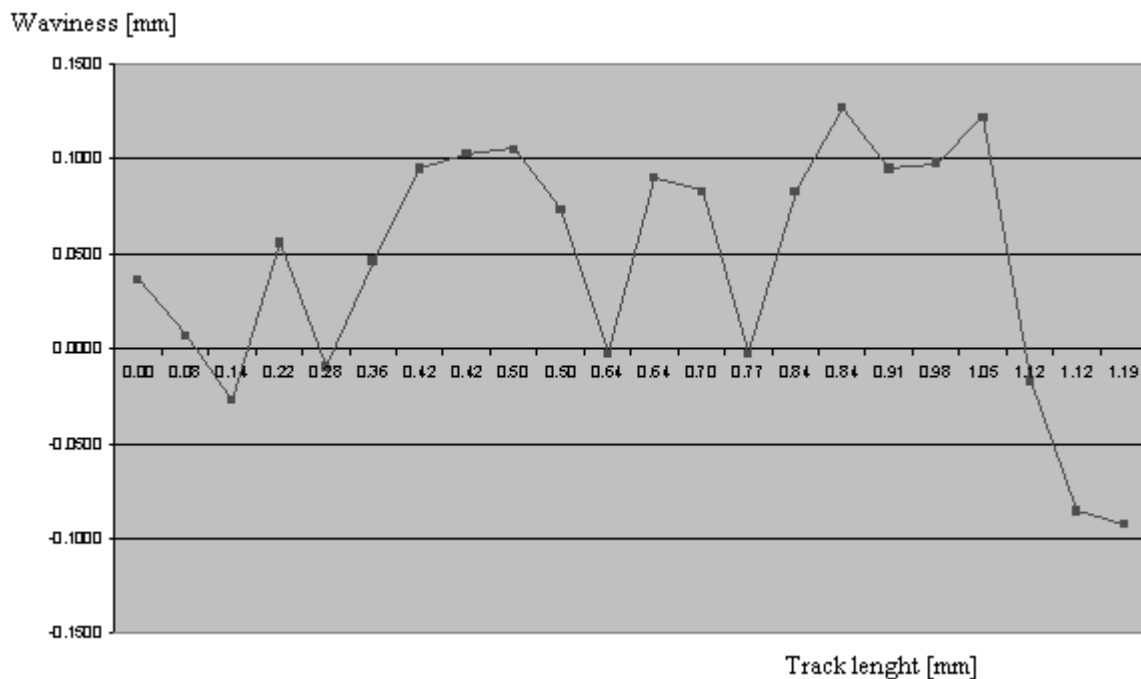

Figure 4. Sampled surface waviness.

4. Simulation program

In this work, the block diagram was very important for the simulation results and its analysis. The system block diagram was simulated in a commercial program, as presented in fig. 5.

Where,

Waviness_1 block: referred to the estimation of the surface waviness when wheel 1 passes on it.

Waviness_2 block: referred to the estimation of the surface waviness when wheel 2 passes on it.

Pulse generator block: Generate pulses at regular intervals. It turns to zero the waviness values when pulse value is 1.

Track interface_in block: Generate pulses at regular intervals. It is referred to the space between tube and track suport when, wheel 1 passes on it.

Track interface_out block: Generate pulses at regular intervals. It is referred to the space between track suport and tube, when wheel 1 passes on it.
Track interface_in2 block: Generate pulses at regular intervals. It is referred to the space between tube and track suport, when wheel 2 passes on it.
Track interface_out2 block: Generate pulses at regular intervals. It is referred to the space between track suport and tube, when wheel 2 passes on it.

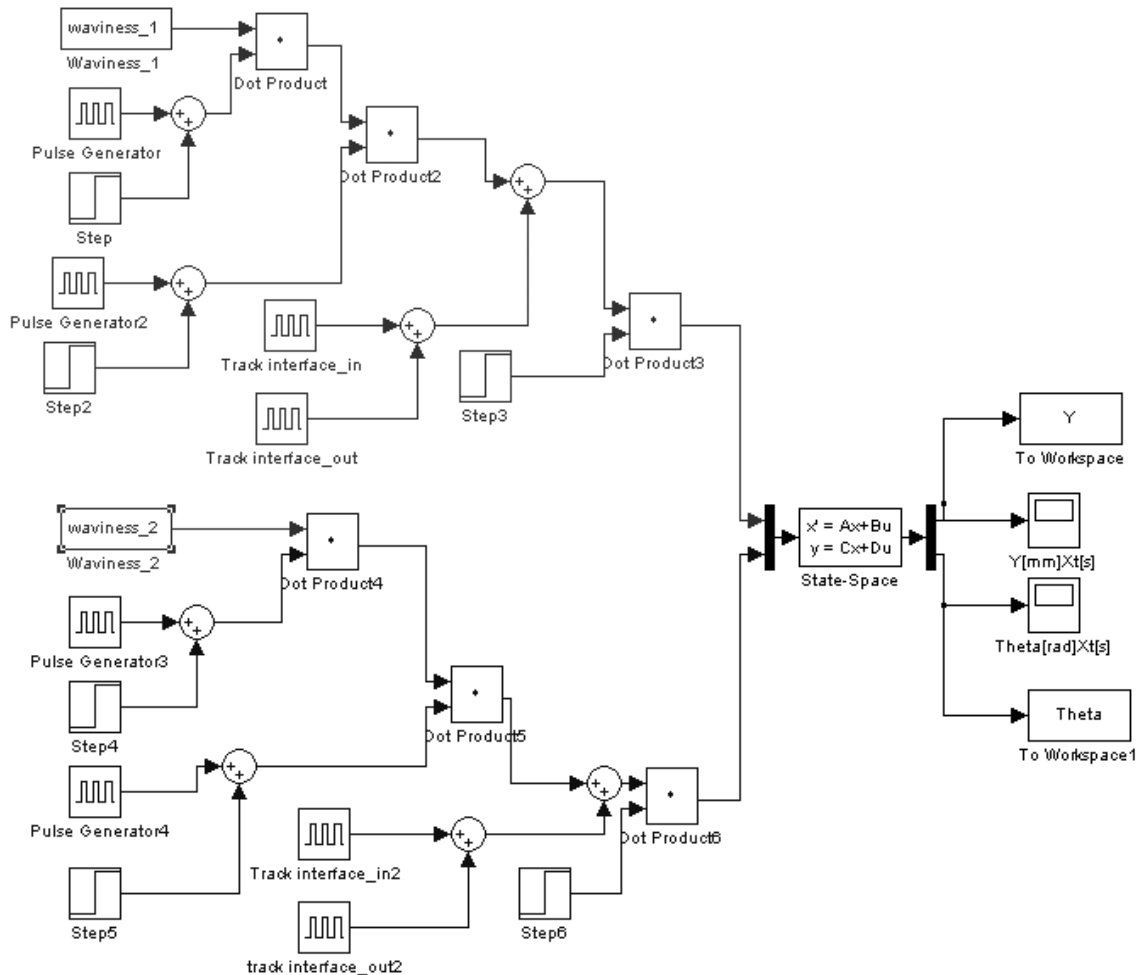

Figure 5. Block diagram of the system

5. Simulation results

The trolley system simulations were performed for the following conditions:

- Tube materials: aluminum, polyethylene (PE) and ABS.
- Tube and track interface: 1 mm, 1.5 mm and 2 mm.
- Different center of mass location (Fig. 1).
- With no damping.
- With damping.
- Using an “ideal” tube without surface waviness.
- Track tube with surface waviness.

From Fig. 6 to Fig. 12 are presented the simulations related to polyethylene and a tube track interface of 2 mm.

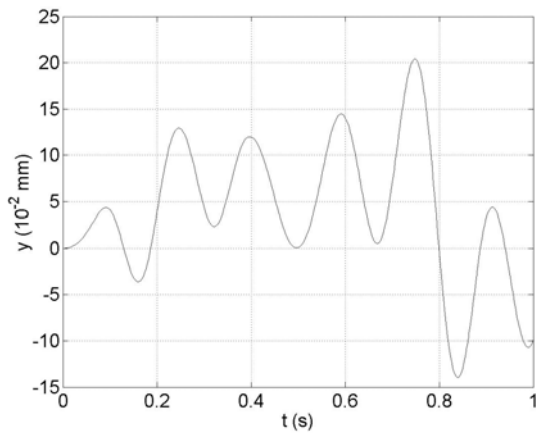

(a)

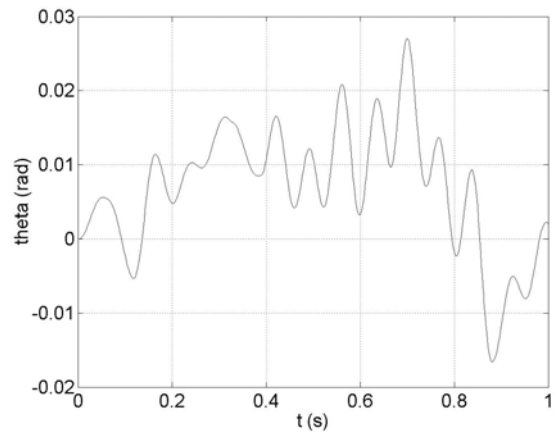

(b)

Figure 6. Material: PE, no damping, $L_1=L_2$ (a) $y[10^{-2} \text{ mm}] \times t[s]$; (b) $\theta[\text{rad}] \times t[s]$.

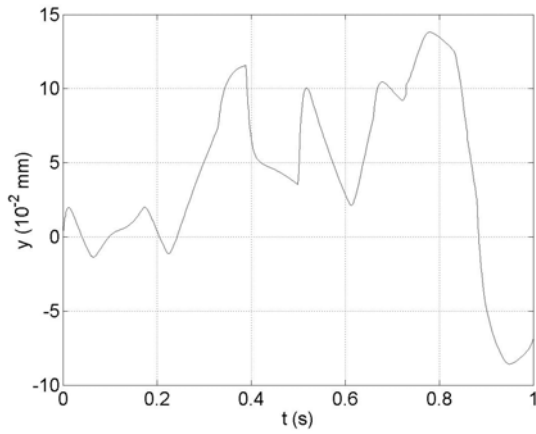

(a)

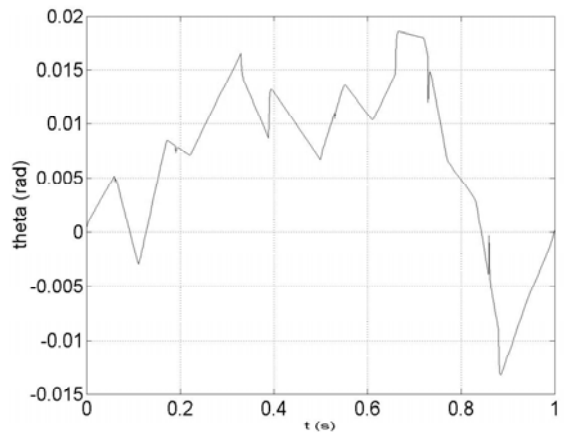

(b)

Figure 7. Material: PE, damped, $L_1=L_2$ (a) $y[10^{-2} \text{ mm}] \times t[s]$; (b) $\theta[\text{rad}] \times t[s]$.

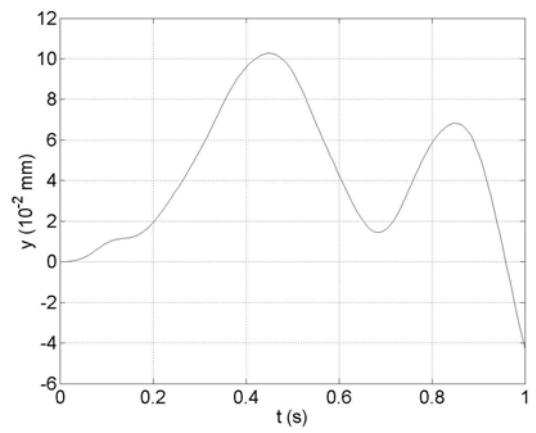

(a)

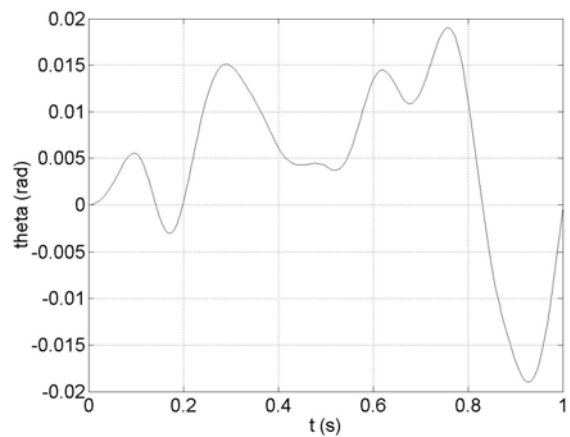

(b)

Figure 8. Material: ABS, no damping, $L_1=2L/5$, $L_2=3L/5$ (a) $y[10^{-2} \text{ mm}] \times t[s]$; (b) $\theta[\text{rad}] \times t[s]$.

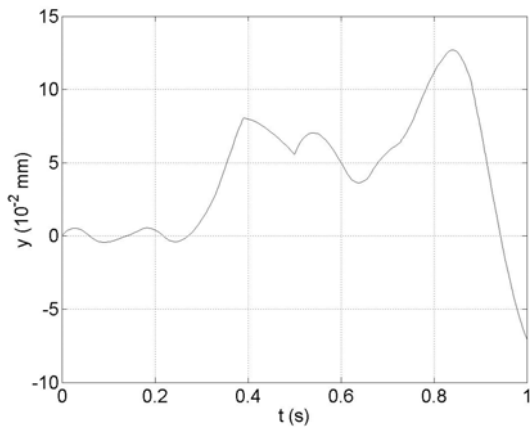

(a)

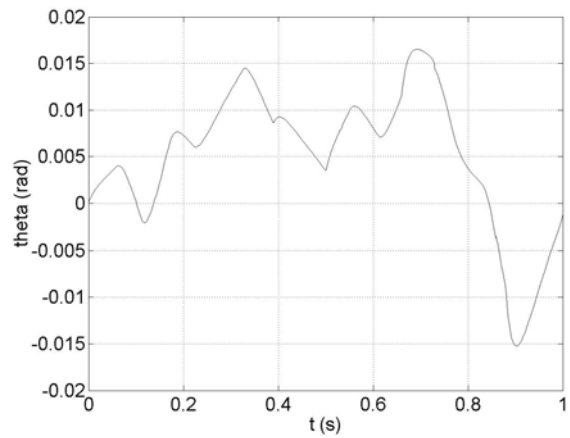

(b)

Figure 9. Material: ABS, damped, $L1=2L/5$, $L2=3L/5$ (a) $y[10^{-2} \text{ mm}] \times t[s]$; (b) $\theta[\text{rad}] \times t[s]$.

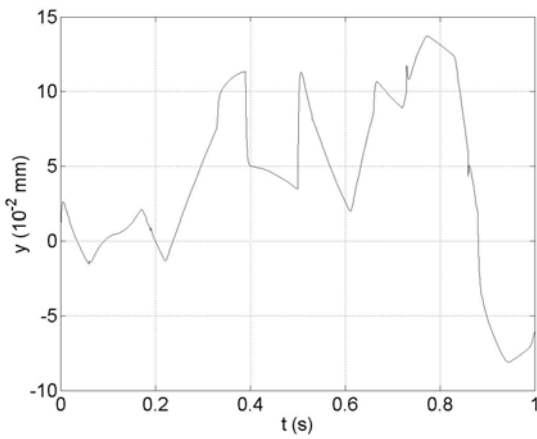

(a)

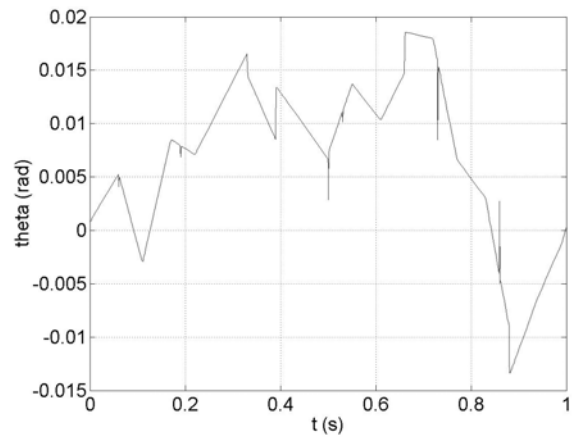

(b)

Figure 10. Material: ABS, damped, $L1=L2$ (a) $y[10^{-2} \text{ mm}] \times t[s]$; (b) $\theta[\text{rad}] \times t[s]$.

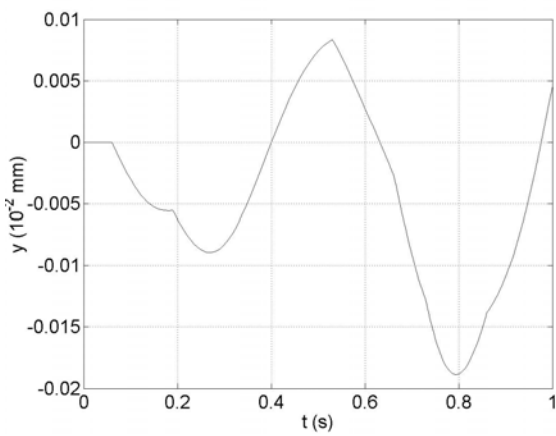

(a)

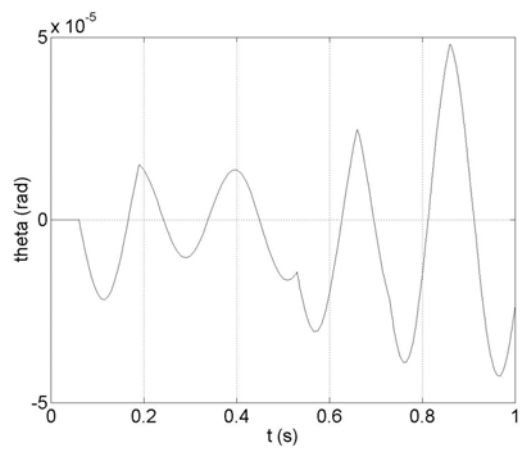

(b)

Figure 11. Material: ABS, no damping, $L1=2L/5$, $L2=3L/5$, tube without surface waviness
 (a) $y[10^{-2} \text{ mm}] \times t[s]$; (b) $\theta[\text{rad}] \times t[s]$.

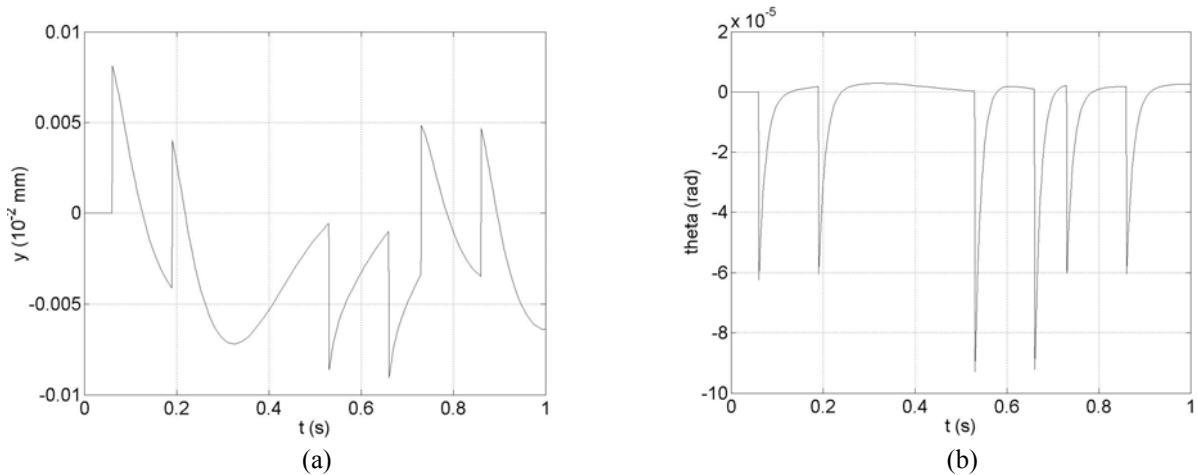

Figure 12. Material: ABS, damped, $L_1=2L/5$, $L_2=3L/5$, tube without surface waviness
 (a) $y[10^{-2} \text{ mm}] \times t[s]$; (b) $\theta[\text{rad}] \times t[s]$.

6. Conclusions

This paper deals with the dynamics of the motion of a wheeled trolley that moves along tracks fixed on the floor, in high speed for TV image generation. The adopted model of a two-degree-of-freedom dynamic model of the trolley-track system was enough to represent its behavior. A state-space solution was used for the dynamic analysis of the system. The main results obtained in simulations can be summarized as follows:

- Although there is quite no difference in the response (Fig. 7 e Fig. 10) of the system with the material wheels in PE or ABS, usually it is a common practice in broadcast industry to use PE wheels. Then, in this project wheels made on PE will be adopted.
- The response of the system is significantly affected by the quality of the tube surface. This can be shown comparing Fig. 8 with Fig. 11 and Fig. 9 with Fig. 12.
- The variation of tube track interface did not interfere substantially in the results.

In future works a control strategy based on an active control device could be studied, so that the results here presented would be useful to determine the most appropriate way to reduce the mechanical vibration of the trolley-track system to acceptable frequency and amplitude ranges, in order to guarantee stable TV images generated during its motion.

7. Acknowledgements

The authors thank Eng. João Paulo Pinto Pereira of the Tecnoflex Engenharia Ltda., Eng. Luis Eduardo Demenicis, Cesar Gomes Ferreira, Cláudio Violante Ferreira and Prof. Ronaldo Carvalho Battista for their valuable and active participation on the previous project. The authors also thank MSc. Gilson Vaz Sampaio and the team from TV Globo Ltda.

8. References

- Beitz, W. and Küttner K.-H., Editors, 1994, "Dubbel Handbook of Mechanical Engineering", Springer-Verlag, German.
- Dorf, R.C., Bishop, R. H., 2001, "Modern Control Systems" (in Portuguese), Ed. LTC, pp. 93-127.
- Romano, V. F., 2002, "Technical Report COPPETEC PEM-2671 - Revision, Analysis and Validation of the Camera-trolley System and Tracks", Mechanical Engineering Department COPPE/UFRJ, (in portuguese), 172 p.
- Romano, V.F., Ferreira, C.V., Ferreira, C.G., 2003, "Telerobotic Trolley Design for TV Transmission", Proceedings of COBEM 2003, 10 pp., in CD
- Romano, V.F., Ferreira, C.V., Ferreira, C.G., 2003, "Mechatronic Design of a Telerobotic Trolley for the TV Transmission", Proceedings of 7th IFAC Robot Control 2003, vol. 1, pp. 85-90, Elsevier LTD, U.K., 2004.
- Romano, V.F., and Trindade, E.C., 2004, "Modeling and Design of a Telerobotic Trolley for the TV Transmission", 4th International Symposium on Robotics and Automation - ISRA 2004, August 2004, Querétaro, Mexico, pp. 629-634.

9. Notice

The authors are the only responsible for the printed material included in this paper.