

PROPOSAL OF A SENSOR MONITORING SYSTEM FOR A MECHATRONIC ORTHOPAEDIC SAW

Talía Simões dos Santos

Technological Institute of Aeronautics, Dept. Mechanical Engineering
Pça. Mal. Eduardo Gomes, 50 - Vila das Acácias
12228-900 - São José dos Campos – SP – Brazil
talía@ita.br

Alfred Makoto Kabayama

Technological Institute of Aeronautics, Dept. Mechanical Engineering
Pça. Mal. Eduardo Gomes, 50 - Vila das Acácias
12228-900 - São José dos Campos – SP – Brazil
alfred@ita.br

Suélia de Siqueira Rodrigues

Technological Institute of Aeronautics, Dept. Electronic and Computational Engineering
Pça. Mal. Eduardo Gomes, 50 - Vila das Acácias
12228-900 - São José dos Campos – SP – Brazil
suelia@ita.br

Luís Gonzaga Trabasso

Technological Institute of Aeronautics, Dept. Mechanical Engineering
Pça. Mal. Eduardo Gomes, 50 - Vila das Acácias
12228-900 - São José dos Campos – SP – Brazil
gonzaga@ita.br

Abstract: *The structure of the mechatronic orthopaedic saw is complex and has mechanical characteristics related to the efficiency and security. The main control parameters in the design of the mechatronic saw are the blades temperature and resisting cutting force. As the intelligent characteristic of the saw is directly related to the cutting process and cutting strategy, the objective of this work is to present a sensor monitoring system for the behavior of the resisting cutting force of the bone. The feed movement is directly involved with this matter because it pushes the saw to the bone and generates a reaction force in the mechanical device characterizing the reaction force. The load cell developed for the mechatronic saw consists of four strain gages, two active and two passive. Finally, an analysis of the behavior of the movement with the application of the resisting force until the stop instant is done, then, an analysis of the behavior of this same system with the application of the resisting force with the insertion of the force sensor. So, a comparison of the two analyses is done to verify the behavior of the sensor in the feed movement of the mechatronic orthopaedic saw*

Keywords: *Mechatronic, sensor monitoring, bioengineering, strain Gage.*

1. Introduction

Even more medical supportive equipments have been incorporated to modern operations rooms. Such devices improve the patient's safety and make possible a number of surgical procedures less invasive and hazardous. Robotic system for surgery has been developed since early eighties and there are some commercially systems already available. Russel (2003) provides a broad overview of medical robot systems used in surgery. It introduces basic concepts of Computer-Integrated surgery, surgical CAD/CAM and surgical assistants.

In the context of orthopaedic knee surgery, osteotomy is a surgical procedure that consists of cutting, realignment and stabilisation of either the upper tibia or the lower femur. Presently, one of the most difficult and potentially dangerous problems associated with osteotomy lies in the fixed configuration of the cutting edge of the saw. This is usually incompatible with the configuration of the bone to be cut and with the access constraints. Moreover, the poor accessibility of many of the cutting sites is another weakness of the current solution. The bone being cut is usually surrounded by soft tissue except for some relatively narrow access wound. As the cutting proceeds and the blade travels deeper into the bone, it becomes impossible to determine with any confidence just where cutting is taking place.

Given the direct relationship between surgical precision and long term post-operative results, automation of the bone cutting process via robot-assistance has been called for to improve the accuracy and repeatability of osteotomy procedures Kabayama et al. (2004). What is needed is an ab-initio, integrated mechatronics approach to the design of the system as a whole; such device presented in this paper is an example of this type of process.

The mechatronic orthopaedic saw is composed by the saw and a specially designed robot; these were designed, right from the very beginning, to be operated together. Consequently, the eight degrees of freedom of the overall system could be split between the saw and the robot in the most convenient and practical way. They are two and six, respectively. The scope of this article is analyze the behavior of the perforation resisting force and propose an efficient sensor monitoring for such variable.

The mechatronic saw depicted in Figure 1 is a self contained unit which has two degrees of freedom namely roll and feed. The roll motion drive is composed of a dc motor, gearbox, encoder and electric brake. It drives a planetary gear train attached to an inner housing running on needle roller bearings within the main body of the saw. Another dc motor is used for the feed motion and drives through a set of bevel and rack gears. The maximum length of the feed motion is 60mm. The cutting action of the saw is implemented by twin circular blades which have semi-rotating motion imposed through a dc motor which drives a mechanism composed by sets of cams and followers.

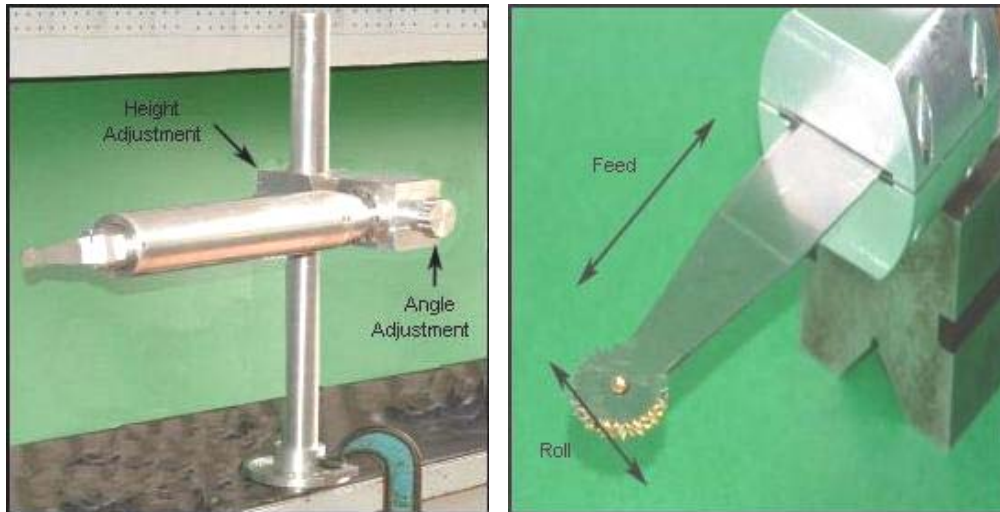

Figure 1 – Mechatronic Orthopaedic Saw.

The difficulties with the traditional solutions for osteotomy were translated into the design requirements of the mechatronic orthopaedic saw as follows: (i) semi-rotating movement of the blades for overcoming the problems associated with the blade breakthrough and allowing precise and stable cutting path, (ii) sterility capability as a surgical requirement, (iii) thermal, force and acceleration feedback for avoiding bone necrosis due to excessive heat and (iv) control by an independent micro-controller linked to surgical robot controller.

In the design of mechatronic saw, one of the main control parameters is a resisting cutting force, as the bones are non uniform structures. After presenting an overview of the mechatronic saw, the paper details the feed movement and the sensor to be used for monitoring the behavior of the cutting force.

2. Mechatronic Saw

Based upon a design methodology proposed by Vidal et al. (2001), the design of the mechatronic saw is composed of requirements that are realized by different systems, integrated through information flux among them. Figure 2 shows the systems that compose this design.

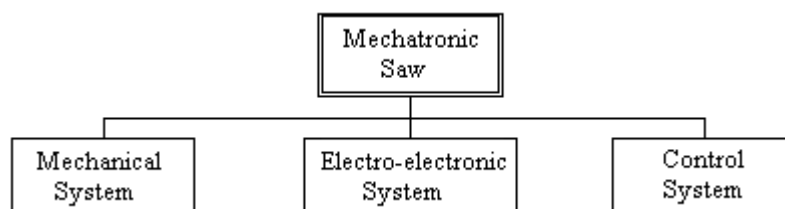

Figure 2 – Diagram of the systems the mechatronic orthopaedic saw.

The structure of the mechatronic orthopaedic saw is complex and has mechanical characteristics that came after efficiency and security optimization. Its structure, according to Rodrigues et al. (2004), has been developed based on trade off studies, which aimed at finding excellent solutions to the assembly of the different parts of the system, and at the same time, sought to meet the practical requirements such as sterility and maintenance.

The mechatronic design principles were fully used in the conceptual phase of saw development process aiming at a compact structure and inclusion of intelligent characteristics in the system.

2.1. Actuation System – Feed Movement

The actuation subsystem is directly related to the numbers of degree of freedom of the mechatronic saw. The feed movement is part of the actuation system of the mechatronic saw which is implemented by electrical actuators. Figure 3 shows an overview of the three movements of the mechatronic saw:

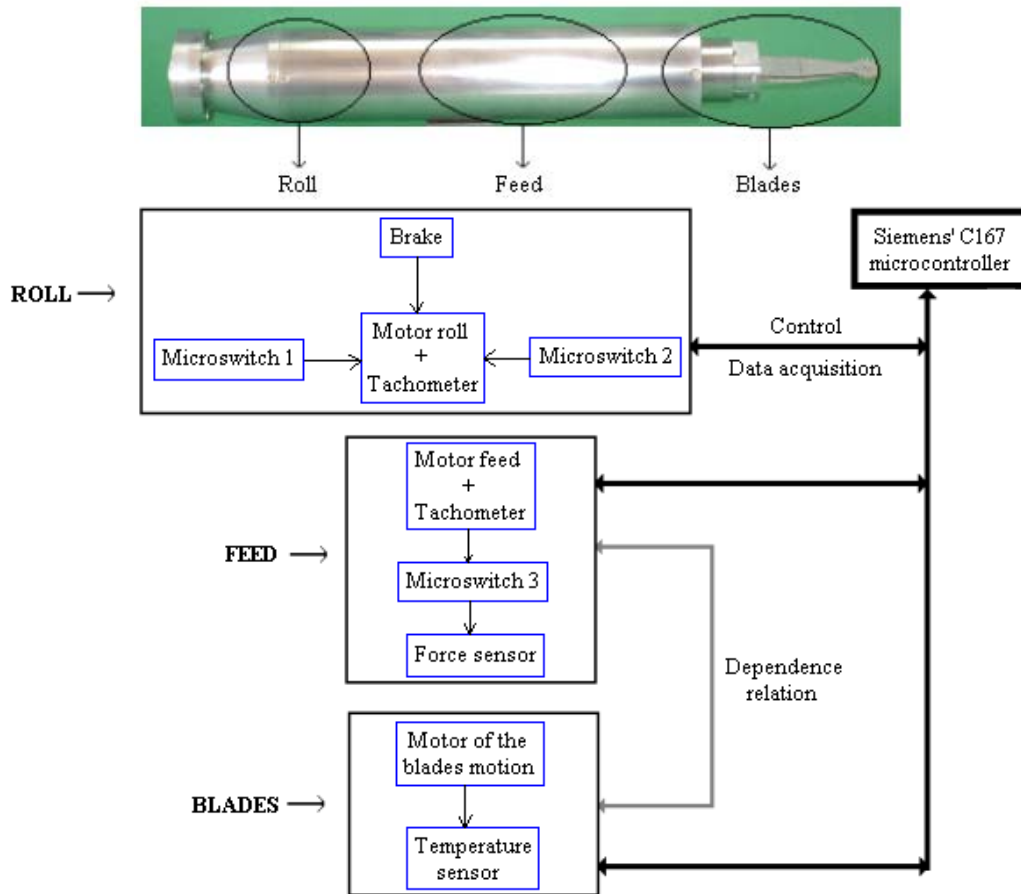

Figure 3 – Block diagram of the movements of the mechatronic saw.

Figures 4 and 5 show the constructive details of the feed mechanism. The feed movement is powered by a motor whose shaft is connected to a gear set that, through a pair of cylindrical racks, moves the saw. The transmission system of the mechatronic saw is composed by shafts, gears, racks and other necessary devices to the execution of the movements, including the reducers connected directly in the output of the motors.

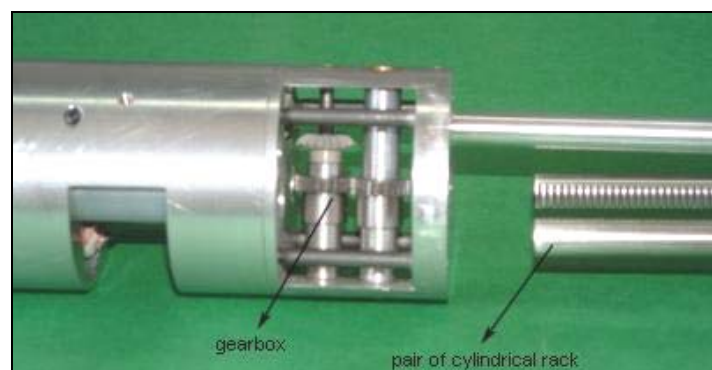

Figure 4 – Feed Mechanism.

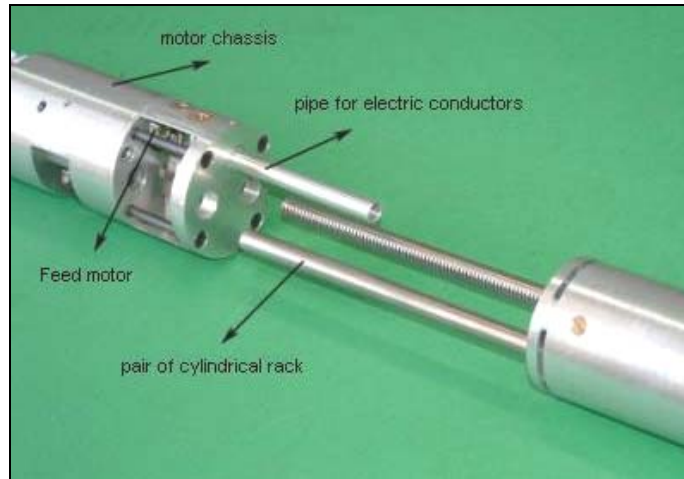

Figure 5 – Constructive details of the feed mechanism.

The modeling of the feed movement was done in Rodrigues (2005) using the modeling language Bond Graph. After that, this model was simplified according to Santos (2005), whose transfer function is given below:

$$G(s) = \frac{8.148}{s^2 + 4.574 \cdot s + 24} \quad (1)$$

This transfer function will be used to simulate the behavior of feed movement of the mechatronics saw including the sensor feedback, whose characteristics are described as follows.

3. Control Strategy

When the blades penetrate the cortical bone, there is a first peak of the axial force, due to the impact on the hard surface of the bone interface. The control algorithm expects that the force decreases, which means that the saw is cutting the softer trabecular bone tissue. When the saw blades reach the second peak, the control algorithm withdraws the blades to their initial position. If any unexpected event happens, such as bone's overheating, the control system takes the suitable measures to overcome the problem.

The Figure 6 depicts the idea that Kabayama (2004) made use from Allotta (1996). Valletta's work regards experiments of bone drilling and it had modeled the axial force along drill's position. Kabayama replaced the drill by a saw in his work. It can be observed the rise of the force when it passes through cortical bone and its reduction when it passes through the trabecular bone. The cutting stop is defined when the saw reaches the second peak of force.

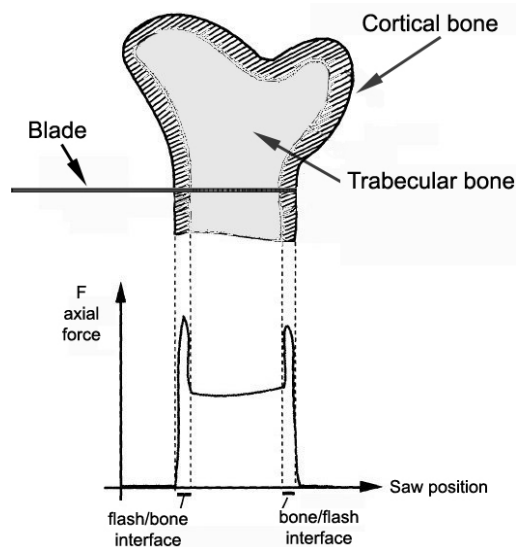

Figure 6 – Force profile during bone cutting.

To get a better understanding of the behavior of the feed movement of the mechatronic saw, it split into 3 stages, described as follow:

- i. When the saw is powered, the blades support moves in the cut plane until the saw finds the bone to be cut;
- ii. The blades start to cut the bone up to the point specified point for the removal of the bone portion, which corresponds to the second peak of the graph of Figure 6;
- iii. The system receives a command signal that retracts the blades support to its initial position.

An important behavior that must be observed is that in the stage (ii), that is, when the saw enters in contact with the bone, there is a perforation resisting force that actuates in the saw - feed movement -, so it generates a variation in the behavior of the feed movement velocity. To illustrate the force influence in the movement velocity, the transfer function of the feed movement will be excited with the following control signal:

$$u(t) = \begin{cases} u_1 = +5 & \text{and } u_2 = 0 & \text{for } 0 \leq t < 30 \text{ sec} \\ u_1 = +5 & \text{and } u_2 = -2 & \text{for } 30 \leq t < 60 \text{ sec} \\ u_1 = -5 & \text{and } u_2 = 0 & \text{for } 60 \leq t < 90 \text{ sec} \\ u_1 = 0 & \text{and } u_2 = 0 & \text{for } t \geq 90 \text{ sec} \end{cases} \quad (2)$$

The negative value adopted for the control signal u_2 represents the cutting resistance force; the response of the system for this control signal is depicted in Figure 7.

It can be noticed in Figure 7 that the blade feed velocity is approximately 9.2 mm/s before making the contact with the cortical bone; whenever the resisting force acts onto the system, the velocity reduces approximately to 7.8 mm/s.

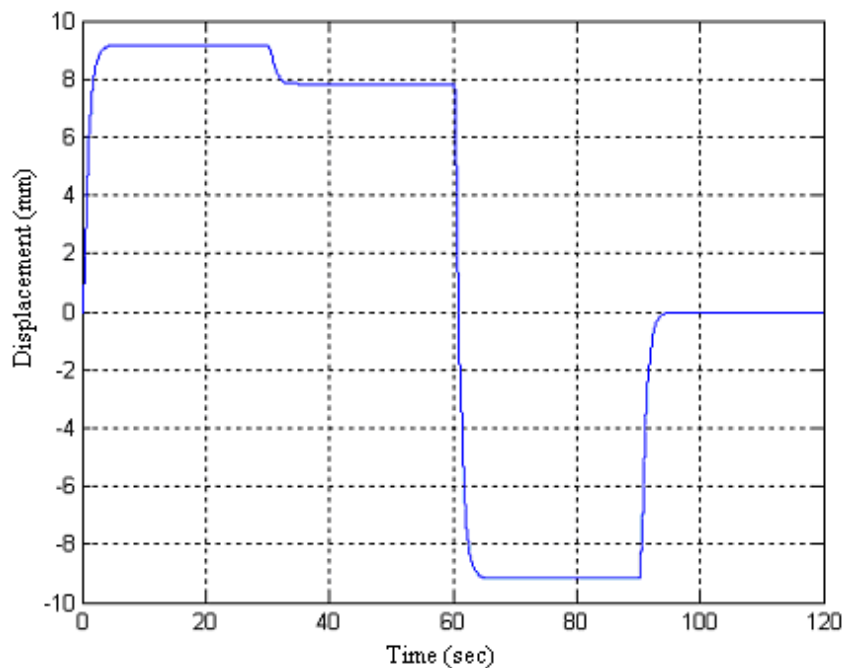
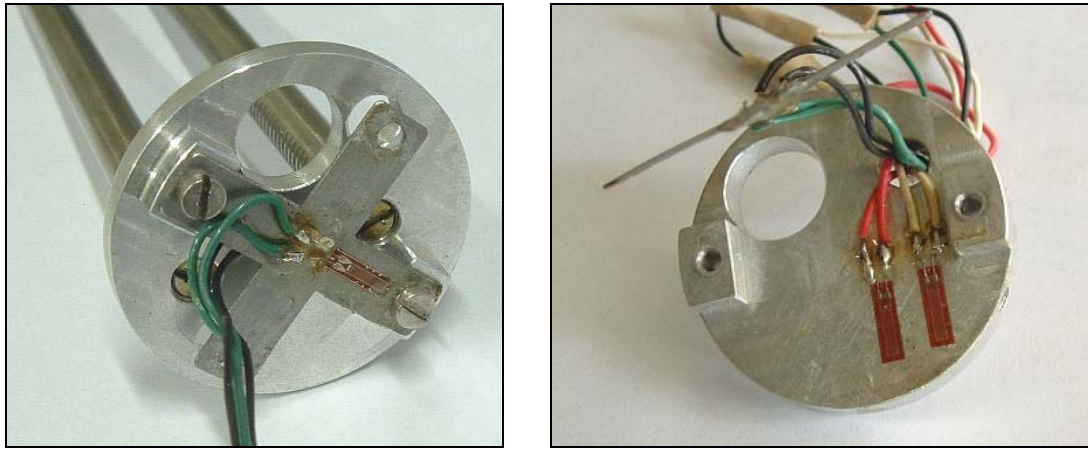

Figure 7 – Feed movement behavior with the resisting force.

3.1 Force sensor characteristics

Figure 8 shows three strain gages glued according to the design of the force sensor, two are in the load cell support (b) and one in the load cell (a). The fourth strain gage does not show in this Figure, because it is glued in the other face of the load cell.



(a) (b)
Figure 8 – Strain gages glue according to the design of the force sensor.

The force sensor was designed according to its positioning in the mechatronic saw: the design chosen for the load cell was cross shaped plate, 0.5mm thick. The cross strain is proportional to the applied force in it. Table 1 presents some technical characteristics of the strain gages used in the cell.

Table 1 – Technical characteristics of the strain gages.

<i>Technical Characteristics</i>	
Length of the gage	2 - 5 mm
Percentage of strain measure	3 until 4% Max.
Temperature interval	-30 °C until +180 °C
Electrical resistance of the gage	120 $\Omega \pm 0.5\%$
Material	plate – nickel-copper league base – polyimide

3.2. Force sensor feedback

It has been designed a circuit for the sensor force to monitor the variation of the force, as shown in Figure 9.

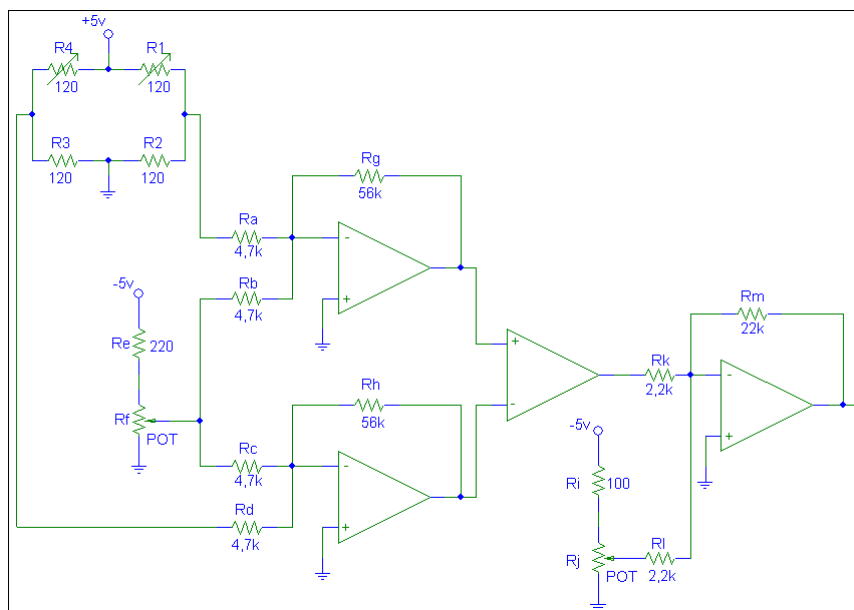

Figure 9 – Force sensor circuit.

The modeling of the sensor circuit above, has yielded the following transfer function:

$$H(s) = 0.9532 \tag{3}$$

Finally, the response of the feed movement system - $G(s)$ - with force sensor feedback is shown in Figure 10.

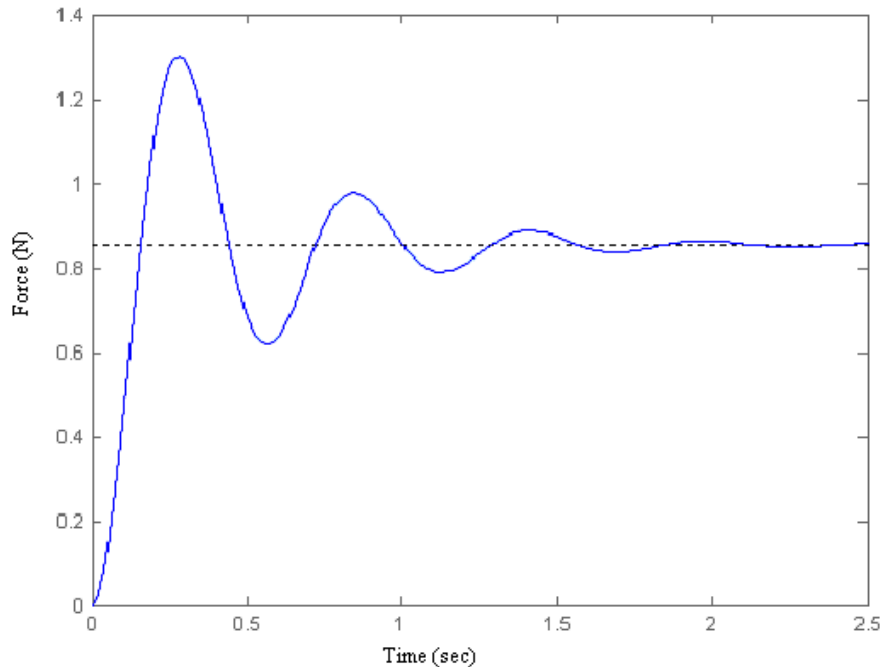

Figure 10 – Response of $G(s)$ with force sensor feedback.

2. The response found shows that the system became faster, but with a high overshoot, as described in the Table

Table 2 – Values of the performance index of the feed system with feedback sensor.

<i>Performance index of $G(s)$ with feedback sensor</i>	
Settling time	$t_s = 1.72s$
Rise time	$t_r = 0.107s$
Overshoot	$M_{pt} = 52.5\%$
Stead error	$e_{ss} \cong 14.5\%$

It can be observed that, in spite of the feed movement has been monitored by a force sensor, it still needs a control law - probably a PID - to improve the values presented in Table 2.

4. Conclusions

This work has yielded the following scientific contributions: the usage of the mechatronic design principles and force sensor monitoring for feed movement of the mechatronic saw.

An initial analysis of the system behavior has shown that the linear feed velocity of the blades decreases when the influence of the perforation resisting force appears. With the insertion of the force sensor and the associated circuit, the resisting force can be monitored, rendering the feed movement system more accurate. As the system has a high overshoot even with this condition, a next research step is to apply a control law to this system.

5. References

ALLOTTA, B.; BELMONTE, F.; BOSIO, L.; DARIO, P., “Study on a Mechatronic Tool for Drilling in the Osteosynthesis of Long Bones: Tool/Bone Interaction, Modeling and Experiments”, *Mechatronics*, Vol. 6, N° 4, pp. 447-459, 1996.

KABAYAMA A.M., SLADE A. P., HEWIT J. R., TRABASSO L. G., “Design And Commissioning of a Mechatronic Orthopaedic Saw”, The 9th Mechatronics Forum International Conference, 2004.

RODRIGUES, S.S.; SIMÕES T.S.; KIENITZ, K.H.; TRABASSO, L.G., “Modelagem e Controle do Suporte das Lâminas da Serra Inteligente Guiada por um Sistema Robótico para Assistência em Cirurgias de Osteotomia”, 3^o Congresso Temático de Dinâmica, Controle e Aplicações - Dincon, Junho 2004.

RODRIGUES, S.S., “Modelagem Dinâmica para Controle de uma Serra Automática utilizada em Cirurgias Ortopédicas”, Tese (Mestrado), Instituto Tecnológico de Aeronáutica, 2005.

RUSSEL, H. T; STOIANOVICI, D., “Medical Robotics in Computer-Integrated Surgery”, IEEE Transactions on Robotics and Automation, Vol. 19, N° 5, October 2003.

SANTOS, T.S., “Desenvolvimento de uma Estratégica de Controle para o Movimento Translacional de uma Serra Mecatrônica Ortopédica”, Tese (Mestrado), Instituto Tecnológico de Aeronáutica, 2005.

VIDAL W.B.F., MOSCATO A. L., LIMA R.G., “Metodologia de Projeto de um Robô para Aplicações Cirúrgicas”, XVI Congresso Brasileiro de Engenharia Mecânica COBEM 2001 pg. 313-322.

6. Responsibility notice

The authors are the only responsible for the printed material included in this paper.