

REVERSAL TECHNIQUE APPLIED TO THE MEASUREMENT OF STRAIGHTNESS ERRORS

Benedito Di Giacomo

University of São Paulo
Av. Trabalhador São-carlense, 400
Centro - São Carlos – SP CEP: 13566-590
e-mail: bgiacomo@sc.usp.br

Rita de Cássia Alves de Magalhães

University of São Paulo
Av. Trabalhador São-carlense, 400
Centro - São Carlos – SP CEP: 13566-590
e-mail: ritamec@bol.com.br

Fabricio Tadeu Paziani

University of São Paulo
Av. Trabalhador São-carlense, 400
Centro - São Carlos – SP CEP: 13566-590
e-mail: fpaziani@sc.usp.br

Abstract. During the displacement of the car on the guideways unwanted movements of translation happens orthogonal to the preferential direction. Such displacements are known as straightness errors. The purpose of this work is the study and development of a system for the measurement of straightness errors in guideways using a straightedge, an electronic comparator (LVDT), a potentiometer, a data acquisition interface and a microcomputer with a computational program to manipulate the data.

keywords. Straightness, Reversal Technique, “End Point Fit” Method.

1. Introduction

Manufacturing process has been developed based on the need of reduction of costs and time of production. The manufacturing process are more and more short, fast and of better quality and it turns the dimensional control expensive and delayed. So, a more flexible, faster and reliable measurement systems for the dimensional control are needed. Thus, the conventional mechanical metrology aided to computer is candidate in potential for the operations integrated with the manufacturing process

During the project of a component the specification of dimensions and forms are based on ideal geometries. How ever due to possible geometric errors on the used machine tools during production process, dimensions and forms are not ideal. The geometrical tolerances, such as flatness, roundness, straightness, parallelism are usually specified in the project. Such errors should be measured and compared with the specified values, so the quality of the part will not be depreciated.

The guideways of machine tool and Three Coordinate Measuring Machine(3CMM) are the elements responsible for the movement of cars and have great influence in the quality of the manufacturing and of the measurement process. These machines are widely used in industry, so it is necessary to study forms for the improvement of the accuracy of these machines. The construction of devices capable to measure the errors in the guideways is interesting to the user and to the maker of machines, because known the guideways's errors the compensation can be made and, therefore, to improve the machine performance.

During the displacement of the car on the guideways unwanted movements of translation happens orthogonal to the preferential direction. Such displacements are known as straightness errors. The purpose of this work is the study and development of a system for the measurement of straightness errors in guideways using a straightedge, an electronic comparator (LVDT), a potentiometer, a data acquisition interface and a microcomputer with a computational program to manipulate the data.

2. Theoretical considerations

Every part has errors and among the forms errors the ones of straightness are fundamental to the great performance of Tools Machines and of the Coordinate Measuring Machine (3CMM). For the measurement of straightness error in guideways some methods can be used, such as the laser interferometer system, autocollimators, standard straightedge with the Reversal Technique, and others. During the measuring using the straightedge the values obtained are mixed up with the misalignment between the artifact and the axis of the guideway displacement. The straightedge errors are included, too. The

misalignment can be eliminated using the “End Point Fit” method or the “Least Square Fit” method. The Reversal Technique can be used to separate the errors of the straightedge and of the guideway.

2.1. Definition of straightness error and for tolerance of straightness

At German VDI/VDE 2617/Part 3 (1989) the definition for straightness error is: “When a reference point on the moveable part of machine moves over its travel range, a line of movement is described. The deviation of this line to a straight line is the straightness error.”

According to BRYAN (1979) “slide straightness error is the non-linear movement that an indicator sees when it is either stationary and reading against a perfect straightedge supported on a moving slide or moved by the slide along a perfect straightedge which is stationary”.

The tolerances are defined by some standards such as the Brazilian ABNT. According to ABNT geometrical tolerances are limits to the dimensional and geometrical deviation of the part and have to be specified in the project. Straightness tolerance controls the deviation of the shape of the feature from its true shape. The tolerance zone, according to NBR6409, is defined by:

- The straightness of the axis of a solid of revolution, as shown in Fig. (1). In this case the tolerance zone is a cylinder whose diameter is the tolerance value.

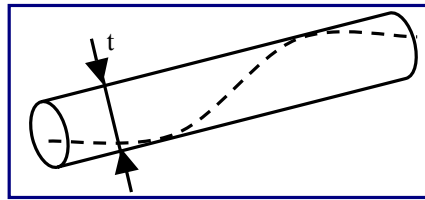

Figure 1. Straightness tolerance of an axis.

When the tolerance zone is the area between two parallel straight lines, in the plane containing the controlled edge, the tolerance value is the distance between the two lines, Fig (2).

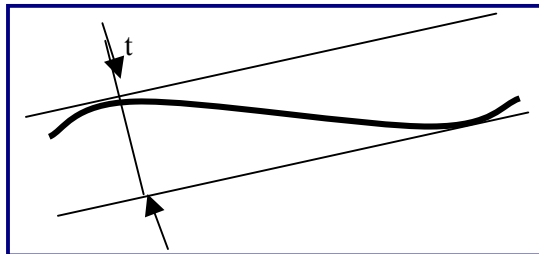

Figure 2. Tolerance zone for an edge.

2.2. Instruments for straightness measurement

The instruments commonly used on the measurement of the straightness errors of machines are the standard straightedge and the interferometer laser measuring system, (ESTLER, 1985).

The standard straightedges are rectangular mechanical artifacts made by cast iron, steal or granite. Their reference surface is, generally, lapped when in steal or granite and handscraping when in cast iron (HOCKEN, 1980).

The straightedge is aligned with the guideway. The measurement is made with a LVDT, on one of the transversal direction of the movement. A pre-calibration of the straightedge is not necessary once the reversal technique (Section 2.4) allows one to remove the straightedge error.

The interferometer laser measuring system are composed by a light source, a beam splitter, a retroreflector and a detector to the interference fringes (THOMAS, 1974).

In the following discussion, the principal on which the interferometer laser is based to measure the straightness error is shown. Two orthogonal linearly polarized beams, with frequencies “ f_1 ” e “ f_2 ”, are incident from the laser head. Component “ f_1 ” circulates within the beam splitter/ retroreflector structure and returns to a detector. Component “ f_2 ” travels twice to the gauging surface and also returns to the detector. Motion of the gauging surface toward or away from the beam splitter cause frequency shifts Δf in the beat frequency at the detector. Displacements are measured by comparing the counts from this detector with counts from a reference detector that measures “ $f_1 - f_2$ ” (ESTLER, 1985).

2.3 Mathematical analysis for straightness error

At the measurement of straightness, misalignment causes a slope to be measured, since the straightedge, for example, is not directing its reference bisector along a path parallel to the axis of the guideway, Fig. 4. This misalignment must be removed from the dates before calculating the true straightness (Hewlett-Packard, 1988). There are some methods used to remove the slope value from dates such as “End Point Fit ” and “Least Squares Fit”.

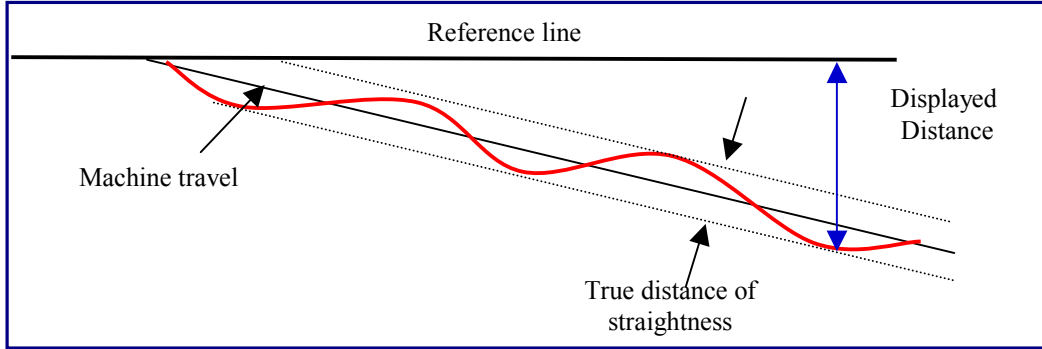

Figure 4. Misalignment between machine travels and reference line.

End point fit method

To remove slope from the measurements data, using the “End Point Fit”, is need to find the line which contains the first and the last date of measurement.

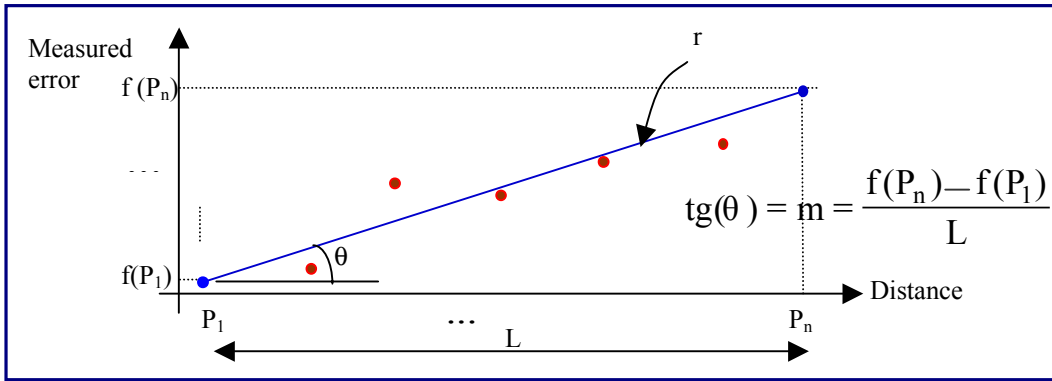

Figure 5: “End Point Fit” Method

By this way, the equation of the line r is identified, Eq. (1).

$$Y_{Slope} = mX + b \tag{1}$$

where:

- Y_{Slope} will be misalignment value;
- X is the distance traveled along the measurement path;
- b is the first straightness reading.

Knowing the misalignment (1), the Y_{Slope} can be calculated for each X along the measurement path. All the Y_{Slope} have to be subtracted from the values of the actually measuring ($Y_{Measured}$), leaving the true straightness error (Y_{True}), Eq. (2).

$$Y_{True} = Y_{Measured} - Y_{Slope} \tag{2}$$

Least squares fit method

Frequently, we want to know how an observation variable depends on previous observations and the dependence of them can be expressed by a curve such as a flat, a straight, etc. In general there is a set of measured points, indicated by: $\{x_1, y_1\}, \dots, \{x_i, y_i\}, \dots, \{x_n, y_n\}$. To fit a function $f(x)$ to this points using the least square method is necessary that:

- The distributions of errors are Gaussian;
- The best function $f(x)$ have to determined by a general function, $f(x, a_1, a_2, \dots, a_p)$ previously chosen. That is to say, the function $f(x)$ have form and number of parameters predetermined.

The second condition means that the best function $f(x)$ is $f(x) = f(x, a_1, a_2, \dots, a_p)$, where the values a_1, a_2, \dots, a_p have to be determined by the least square method (LSM).

According to the least square method the best approach for the function to be fit, $f(x)$, happens when the parameters a_1, a_2, \dots, a_p minimize the sum, S , of the squares of the residuals (difference between the measured values and the values calculated by the LSM) :

$$S = \sum_{i=1}^N \left| y_{Measured,i} - f(x_i; a_1, a_2, \dots, a_p) \right|^2 \quad (3)$$

To determine the straightness error it is necessary to fit a straight to the set points measured. The linear model to be fit is given by Eq. (4), where ϵ_i is the residual value and a_1, a_2 are the parameters to be calculated.

$$f(x_i) = a_1 + a_2 \cdot x_i + \epsilon_i, \quad i=1, \dots, N \quad (N \geq 2) \quad (4)$$

The residual value is a random variable, independently and identically distributed, that is with normal distribution of mean zero and variance constant.

As previously stated, the LSM minimize the sum of the square of the residual and, therefore, to fit the points to a straight the following sum is minimized:

$$S = \sum_{i=1}^N (y_i - (a_1 + a_2 \cdot x_i))^2 \quad (5)$$

To minimize Eq. (5), the partial derivatives of S with respect to a_1 and a_2 have to be null. By this way, can be obtained the following expressions, Eq. (6), called normal expressions.

$$\begin{cases} \sum_{i=1}^N y_i = a_1 \times N + a_2 \sum_{i=1}^N x_i \\ \sum_{i=1}^N x_i \times y_i = a_1 \sum_{i=1}^N x_i + a_2 \sum_{i=1}^N x_i^2 \end{cases} \quad (6)$$

Solving Eq. (6), the parameters of LSM can be given by Eq. (7), where \bar{x} and \bar{y} are the arithmetic averages of x_i and y_i , respectively.

$$a_2 = \frac{\sum_{i=1}^N y_i \cdot (x_i - \bar{x})}{\sum_{i=1}^N (x_i - \bar{x})^2} \quad a_1 = \bar{y} - a_2 \cdot \bar{x} \quad (7)$$

Equation (7) are always the only solution for Eq. (5) if not all x_i are the same.

This way, the straight, which fits better to the points, can be chosen, Eq. (8).

$$f(x) = a_1 + a_2 \cdot x \quad (8)$$

where :

- $f(x)$ is the misalignment;
- x is the distance traveled along the measurement path.

Knowing the misalignment (8), the $f(x_i)$ can be calculated for each X along the measurement path. All the $f(x_i)$ have to be subtracted from the values of the actually measuring ($Y_{Measured}$), leaving the true straightness error (Y_{True}), Eq. (9).

$$Y_{True} = Y_{Measured} - f(x_i) \quad (9)$$

2.4. Reversal Technique

As previously mentioned, even a standard straightedge does not have the measuring face perfectly straight. The existing form errors in the straightedge and in the guideways are mixed up hindering the measurement. This problem can be solved using the reversal technique (CAMPBELL, 1995).

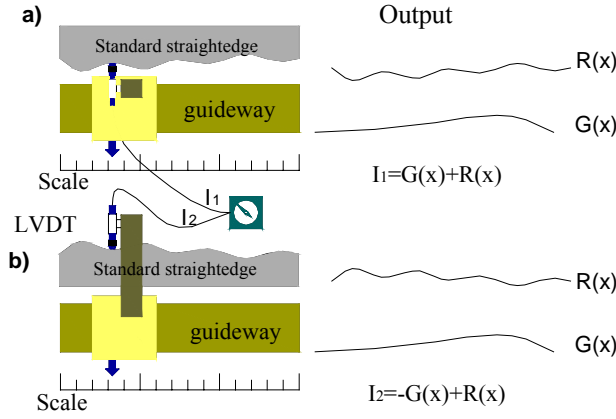

Figure 6. Reversal Technique schematic for the straightness errors measurement.

Figure (6.a) shows an assembly to the guideways straightness measurement error using a straightedge and a transducer (LVDT), which indicator output is I_1 . Figure (6.b) shows the straightedge rotated 180° . In the transducer the output L_2 is displayed. Assume that the machine slide straightness is given by $G(x)$ and the departure of the straightedge is given by $R(x)$, the indicator output, $I_1(x)$ for the two positions are given at Eq. (10) and (11).

$$I_1(x) = G(x) + R(x) \quad (10)$$

$$I_2(x) = -G(x) + R(x) \quad (11)$$

So that, the solution for the machine slide and for the straightedge straightness error are given at Eq. (12) and (13) (EVANS et al, 1996):

$$G(x) = \frac{I_1(x) - I_2(x)}{2} \quad (12)$$

$$R(x) = \frac{I_1(x) + I_2(x)}{2} \quad (13)$$

In general, the result of a measurement is only an approximation or estimate of the value of the measurand and thus is complete only when accompanied by a statement of the uncertainty of that estimate. It happens because there are many possible sources of uncertainty in measurement, including: deviation assigned to the instruments, to the operator, to the effects of environmental conditions, and others (GUM, 1993).

In most cases, the best available estimate of an expected value of a quantity X , for which N independent observations X_i , obtained under the same conditions of measurement, is the arithmetic average (\bar{X}). The experimental standard deviation is given by s , Eq. (14):

$$\bar{X} = \frac{\sum_{i=1}^N X_i}{N} \quad \text{e} \quad s = \sqrt{\frac{\sum_{i=1}^N (X_i - \bar{X})^2}{N-1}} \quad (14)$$

where:

- X_i is the straightness departure of the straightedge, $R(x_i)$, or of the guideway, $G(x_i)$, for each measured point;
- \bar{X} is used to determine the straightness result of the machine's guide or of the straightedge, for a position;

- s is the standard deviation and characterize the variability of the observed values X_i ;
- N is the number of observations.

For a normal distribution, the probability of a measured value be in a interval can be determined $[\bar{X} - is, \bar{X} + is]$ with $i = 1, 2, 3$ using the percentages given at Figure 7.

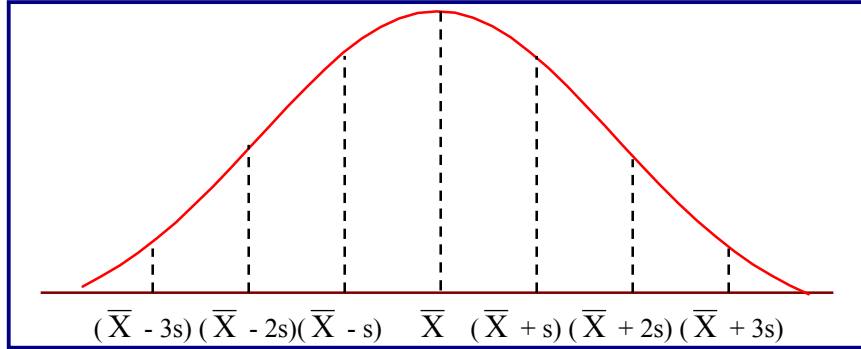

Figure 7. Normal distribution graphic.

In most cases a measurand Y is not measured directly, but is determined from N others quantities X_1, X_2, \dots, X_N , called input quantity, through a functional relationship f .

$$Y = f(X_1, X_2, \dots, X_N) \quad (15)$$

The standard uncertainty of y , where y is the estimate of the measurand Y and thus the result of the measurement, is obtained combining the standard uncertainties of the input estimates, using the “law of propagation of uncertainty”. The combined standard uncertainty $u_c(y)$, considering Eq. (15), is the positive square root of the expression (16), where:

- $u(x_i)$ is the standard uncertainty of input estimates x_i , $u(x_i) = \sqrt{s^2}$;
- $r(x_i, x_j)$ estimated correlation coefficients associated with input estimates x_i e x_j .

$$u_c^2(y) = \sum_{i=1}^N \left(\frac{\partial f}{\partial x_i} \right)^2 u^2(x_i) + 2 \sum_{i=1}^{N-1} \sum_{j=i+1}^N \frac{\partial f}{\partial x_i} \frac{\partial f}{\partial x_j} u(x_i) \cdot u(x_j) \cdot r(x_i, x_j) \quad (16)$$

To determine the uncertainty of the measurand in this work, only the uncertainty of the comparator was considered. The uncertainty of the straightness error of the straightedge and of the guideway can be determined by the positive square root of $u^2(R(x))$ and of $u^2(G(x))$:

$$u^2(R(x)) = \left(\frac{\partial R(x)}{\partial L_1} \right)^2 [u(L_1(x))]^2 + \left(\frac{\partial R(x)}{\partial L_2} \right)^2 [u(L_2(x))]^2 \quad (17)$$

$$u^2(G(x)) = \left(\frac{\partial G(x)}{\partial L_1} \right)^2 [u(L_1(x))]^2 + \left(\frac{\partial G(x)}{\partial L_2} \right)^2 [u(L_2(x))]^2 \quad (18)$$

3. Methods employed to estimate straightness error

From the previously studied topics, reversal and end points methods were employed to estimate straightness error of the slides.

An interferometric laser system was used in this work to verify the reliability of the constructed system. Such a decision was taken because interferometric laser systems for metrological use have been considered as standards.

Straightness error of the slide was estimated using electronic probing, a potentiometer and a straightedge. The connection between computer and measurement instruments was made by means of a proper data acquisition interface, which converts analogical signals from probe and potentiometer into digital signals.

The data acquisition card employed has 12 bits resolution and operation range from $-5V$ to $+5V$. The multi-turn potentiometer was attached to the carriage. When the carriage is moved, the potentiometer shaft is rotated and the resistance between central and end lugs changes, varying the dc tension on the potentiometer. Thus, the position of the probe with relation to the straightedge is known. A schematic representation of the constructed system is shown in Fig. 8.

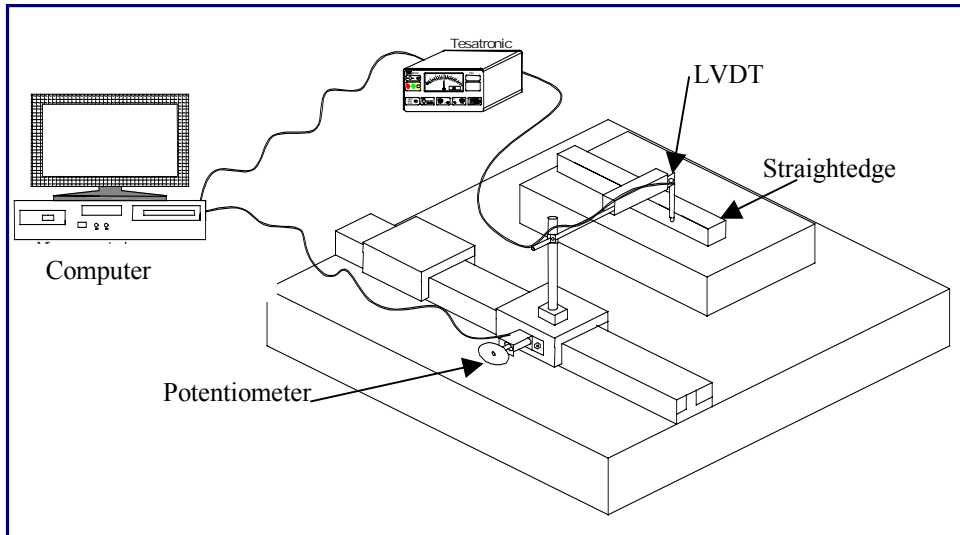

Figure. 8. Straightness error measurement setup.

Provided that the signals from potentiometer and probe computer are available to the computer, it was possible to create a computational algorithm to estimate the straightness error. The algorithm was developed using Borland Delphi and it estimates straightedge and slide straightness errors. The results are shown as error against displacement graphs. The main screen of the algorithm can be seen in Fig. 9. Some entries must be chosen by the user, via keyboard. These entries are: length of the slide, number of runs to be performed and number of points to be collected. Next, the algorithm starts to acquire data from the A/D converter. These data are then read as displacements after they are weighted by a pre-determined calibration curve. When the carriage is moved, tension over the potentiometer lugs changes and the reading from the displacement probe is collected as it shifts through the positions previously defined by the user.

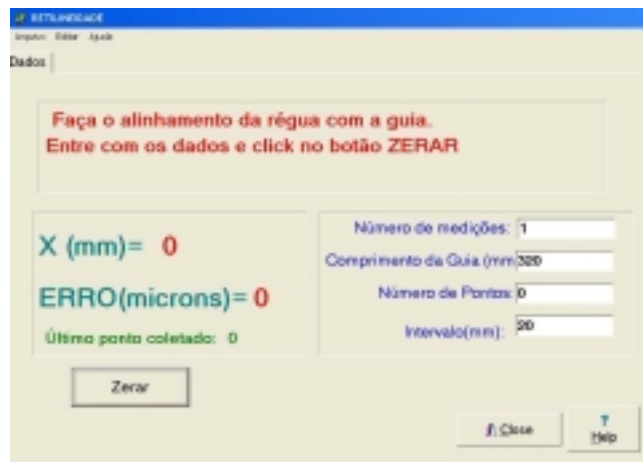

Figure. 9. Algorithm main screen.

In order to estimate straightness error of the slide, the subsequent steps were followed: firstly, the displacement probe was attached to a carriage that moves on the slide. The straightedge was placed close to the slide and then aligned making zero the reading of the displacement probe both on the first and on the last measurement points.

A number of three forward runs and three backwards runs were performed. Seventeen positions along the measurement path were observed. When the button “ZERAR” is hit on the main screen, the user defines the initial measurement position.

Final position was set 340 mm from start and the increment was defined as 20 mm, both values are user-defined. Next, the straightedge was reverted around its longitudinal axis and the same procedure was executed. After collecting the whole data set, the algorithm performed a series of calculations using the reversal method and the end points method. Finally, straightedge and slide error against displacement graphs are displayed on the screen, as shown in Fig.10.

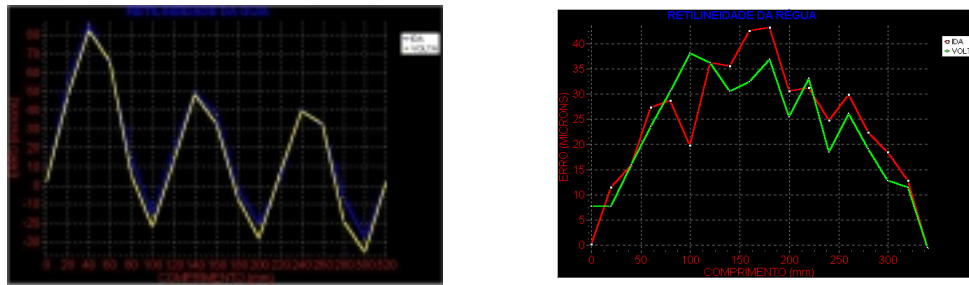

Figure. 10: Slide and straightedge straightness errors estimated by the proposed system.

On the purpose of evaluating the developed system, slide straightness error was simultaneously evaluated by a laser interferometric system. Figure 11 shows the results for measurement using the proposed system and the laser interferometric system for the forward run.

A comparative analysis was performed for the results obtained by both methods, between mean and standard deviation values.

The highest amplitude value observed for straightness error estimated by the proposed system was 115 μm and $\sigma = 24 \mu\text{m}$ within 95% confidence factor, whereas values obtained from the laser interferometric system were 103 μm and $\sigma = 12 \mu\text{m}$ within 95% confidence factor. The discrepancies remain within 10% and indicate that the proposed method can provide a reliable estimate for straightness error evaluation

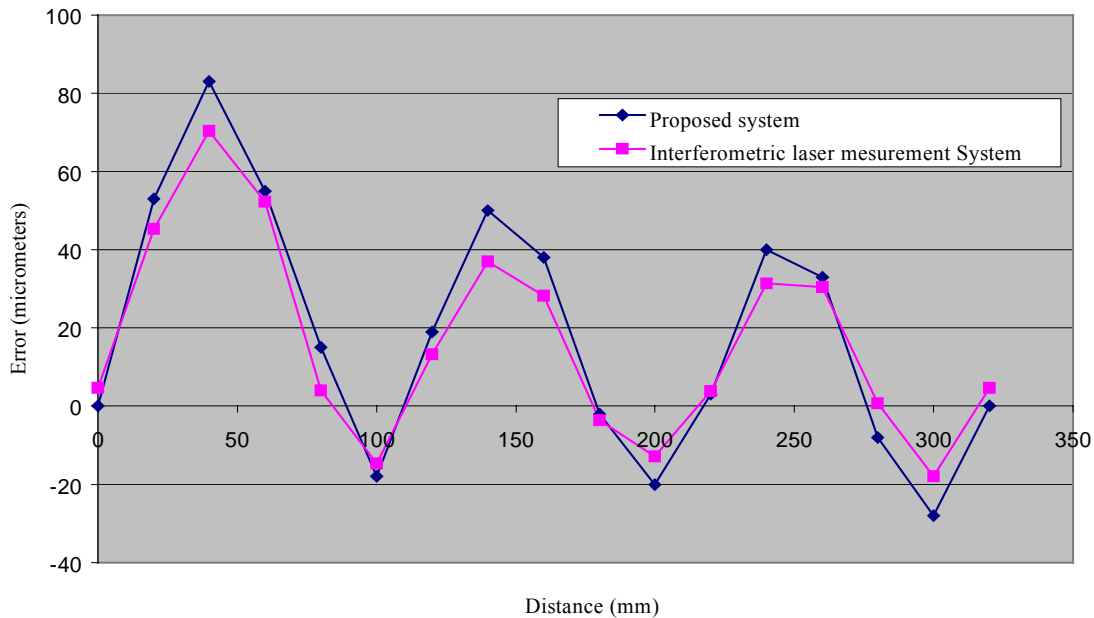

Figure 11. Slide straightedge error estimated by the proposed method and the laser interferometric system,

4. Conclusions

The aim of this project was to develop a measuring system to evaluate slide straightness error by means of the reversal and end points methods. From experimental testing, the following significant points can be highlighted:

- The application of the reversal method requires that the displacement probe readings are always taken on the same line on the straightedge. It must be emphasized that a digital encoder should be employed to measure the position of the carriage on the slide. In this work, however, the encoder was replaced by the multi-turn potentiometer, which was efficient to measure the position of the carriage, with good repeatability and it is also less expensive;

- It is not necessary to pre-calibrate the straightedge because the reversal method allows straightedge error decoupling;
- The obtained results presented 90% confidence factor with relation to values obtained with the laser interferometric system;
- The proposed system requires much less expenditure in order to be implemented if compared to the laser interferometric system. The costs to build the former system were about US\$3,300 and the latter demands up to US\$60,000.
- Measurement time was about 20 minutes. On the other hand, the laser interferometric system requires a trained operator, due to the optics alignment procedures, which are not simple to execute. Alignment time was about 30 minutes and measurement time was about 20 minutes.

5. Acknowledgements

The authors would like to express their appreciation to CNPq - Conselho Nacional de Desenvolvimento Científico e Tecnológico and to FAPESP- Fundação de Amparo à Pesquisa do Estado de São Paulo, who have supported this project.

6. References

- ABNT/NBR 6409(1980). Tolerâncias de forma e tolerância de posição.
- BRYAN,J.B. (1979) The Abbè principle revisited: na updated interpretation. Precision Engineering, vol.1, N01, Jul.: 129-132.
- CAMPBELL, A(1995) Measurement of lathe Z-axis straightness and parallelism using a flat land, Precision Engineering Vol 17 no 3 pp 207-210.
- ESTLER,W.T. (1985) Calibration and use of optical straightedges in the metrology of precision machines. Optical Engineering, Vol. 24, N°3, May,Jun:372-379.
- EVANS, C.J.; HOCKEN, R.J.; ESTLER,W.T.(1996) Self-Calibration: reversal, redundancy, error separation, and “absolute testing”,CIRP Annals, Vol45/2.
- GUM ISO TAG 4/WG 3 – *Guide to the Expression of Uncertainty in measurement*, Geneva Switzerland, 1993.
- HEWLETT-PACKARD (1988) Laser Measurement System 5528A User’s Guide.
- HOCKEN, R.J. & MACHINE TOOL TASK FORCE (1980). *Machine tool accuracy*.Technology of Machine Tools, vol.5, Oct.
- THOMAS,G. (1974) Engineering Metrology, chapter1. Betterworth&Co.Ltd.
- VDI/VDE 2617 (1989) Accuracy of Coordinate Measuring Machines Part 3: Components of Measurement Deviation of the Machine.