

A MATHEMATICAL MODEL FOR THE VELOCITY PROFILE INTERNALLY TO A CONICAL DIFFUSER

Disterfano Lima Martins Barbosa, delimamb@gmail.com

Jerson Rogério Pinheiro Vaz, jerson@ufpa.br

Déborah Aline Tavares Dias do Rio Vaz, deborahvaz@ufpa.br

Sávio Wesley Oliveira Figueiredo, savio.figueiredo@itec.ufpa.br

Marcelo Oliveira da Silva, mos@ufpa.br

Claudio José Cavalcante Blanco, blanco@ufpa.br

Universidade Federal do Pará – Rua Augusto Corrêa, 01 – Guamá. CEP 67075-110. Belém – Pará.

Abstract: *The use of diffusers around of the horizontal-axis wind turbines have been widely studied, since the diffuser causes an improvement in the power coefficient of a turbine and are often called Diffuser Augmented Wind Turbines (DAWT's). The DAWT's have the feature to make efficiency exceeding the Betz limit (maximum energy flow extracted = 59.26%), due to the increasing of the internal mass flow by influence of the diffuser. Thus, in the present study shows a mathematical model describing the behavior of the velocity profile internally to a diffuser according to the characteristics of flow and geometry of a conical diffuser. The results are compared with experimental data and show good agreement.*

Keywords: *DAWTs, Diffuser, Renewable energy.*

1. INTRODUCTION

The use of diffusers around of the horizontal-axis wind turbines aims at increasing the mass flow through the rotor. This effect causes a considerable improvement in the efficiency of the turbine, which extracts more energy of the flow, when compared with a turbine without diffuser (free-flow turbines). For comparison, the increment caused by the use of a diffuser may take a turbine to achieve a power coefficient between 4 to 5 times greater than free-flow turbine (Ohya and Karasudani, 2010). A diffuser is a device which causes a pressure drop in the output region (suction region downstream of the diffuser). The pressure drop causes an acceleration on the fluid particles within the diffuser, increasing the flow velocity near the entrance (Bussell Van, 1999). Oman et al., (1975), Foreman and Gilbert (1979) show that increasing the velocity ratio between the plane of the rotor and undisturbed flow velocity can be two or more times, resulting in a proportional increase in the power coefficient of the turbine, exceeding the Betz limit (Betz, 1926), which is 59.26% in the case of the turbines without diffuser. Hansen et al., (2000) conducted a study on turbines with diffusers using Computational Fluid Dynamic (CFD), where the increasing of the velocity in the rotor plane was 1.83 for a case in which the geometry of the diffuser used was the NACA 0015 profile deformed.

The main limitation of the horizontal-axis wind turbines with diffusers design is not consider a formulation that is able to describe satisfactorily the influence of the diffuser geometry on the internal velocity profile. Thus, the present study shows a mathematical model which describes the velocity profile of the internal conical diffuser, using the Biot-Savart law to calculate the velocity induced by a vortex ring.

2. MATHEMATICAL MODEL

In this paper, we described a mathematical model for the velocity profile internally to a conical diffuser, aiming its use in the efficient design of the horizontal-axis wind turbines. Therefore, to assess the velocity field in the diffuser flow is considered to be an overlap between the uniform flow and a flow caused by movement produced by a vortex ring. The movement in this case can be defined as the amount of rotation of the fluid acting on the spreader due to the flow in which is immersed. The movement modifies the velocity and pressure fields around the diffuser, resulting in a resultant force, which is accompanied by a vortex ring, which mathematical model is established by the Biot-Savart law, resulting in an increased velocity within the diffuser. The Biot-Savart is defined by:

$$d\vec{u}_* = \frac{K}{4\pi r^3} d\vec{l} \times \vec{r} \quad (1)$$

where $d\vec{u}_*$ is the velocity field induced, $d\vec{l}$ is an elemental length of the vortex ring, \vec{r} is the position vector and K is the circulation.

Figure 1 shows two rings vortices using the Biot-Savart formulation, in cylindrical coordinates, where it is necessary to define the vortex element and position vector in relation to the axis of symmetry.

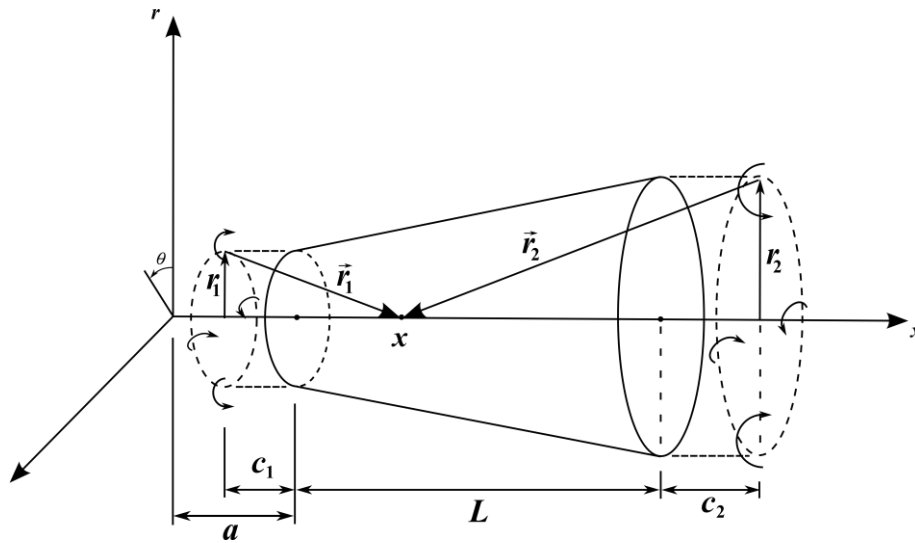

Figure 1. Representation of the geometry model and the vortex rings.

The mathematical model considers the following assumptions: conical diffuser, the suction outlet of the diffuser is modeled using a vortex ring; the lock due to the presence of the diffuser on the flow is modeled considering a vortex ring invert steady and unidirectional. Therefore, applying the Biot-Savart law and taking only the velocity in the direction along the axis of the diffuser, there is the velocity induced by vortex rings:

$$u_*(x) = \frac{1}{2} \left\{ \frac{K_2 r_2^2}{[r_2^2 + (L + a - x + c_2)^2]^{\frac{3}{2}}} - \frac{K_1 r_1^2}{[r_1^2 + (x - a + c_1)^2]^{\frac{3}{2}}} \right\} \quad (2)$$

where r_2 is the radius of the diffuser exit, r_1 is the radius of the diffuser inlet, L is the length of the diffuser, a is the distance from the origin to the input of the diffuser, c_1 e c_2 are the distances between the rings of the vortex entry and exit of the diffuser, respectively.

For calculation of the circulations K_1 e K_2 , it is considered the geometry of the diffuser, the behavior of the flow around the diffuser and the structure of the vortex formed in the entrance and exit as it is shown in Fig. 2.

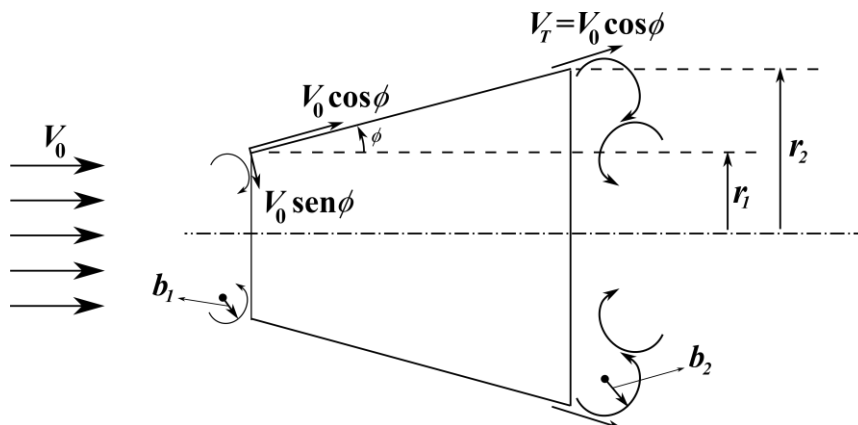

Figure 2. Model of the vortices at the inlet and outlet of the diffuser.

Thus, for calculating the circulation K_2 , it is released the hypothesis that the radius of the vortex b_2 shown in Fig. 2 is proportional to the difference between the radio at the outlet and the inlet of the diffuser ($r_2 - r_1$), and that its tangential velocity V_T is proportional the product of the undisturbed velocity V_0 by the cosine of the opening angle ϕ of the diffuser.

Therefore, the circulation K_2 is given by:

$$K_2 = \xi_2 V_0 \cos \phi (r_2 - r_1) \quad (3)$$

where ξ_2 is a proportionality constant and acts as a correction factor. To determine the circulation K_1 , it is used the same hypothesis, applied to the input of the diffuser, then K_1 becomes:

$$K_1 = \xi_1 V_0 \sin \phi (r_2 - r_1) \frac{c_1}{L + c_2} \quad (4)$$

Van Beveren (2008) shows that the velocity profile of the internal diffuser is given by the sum of the velocity induced by the ring vortex and undisturbed flow velocity:

$$u(x) = V_0 + u_*(x) \quad (5)$$

The aspect ratio r_a relates the length of the diffuser L with its inlet diameter d :

$$r_a = \frac{L}{d} \quad (6)$$

In the present work, it is referenced when the longitudinal axis of symmetry or diffuser, it will only be used the term 'axis'.

3. EXPERIMENTAL SURVEY

Model validation was performed in an experimental study of airflow around a conical diffuser, in order to obtain the velocity profile along the axial length (axis) of the diffuser. The corresponding experimental data were taken by (Figueiredo, 2012). Figure 3 illustrates the experimental apparatus. The dimensions of the diffusers are: inlet diameter of 115 mm, outlet diameter of 259 mm and length of 87 mm. These dimensions were therefore used in the mathematical model proposed in this work.

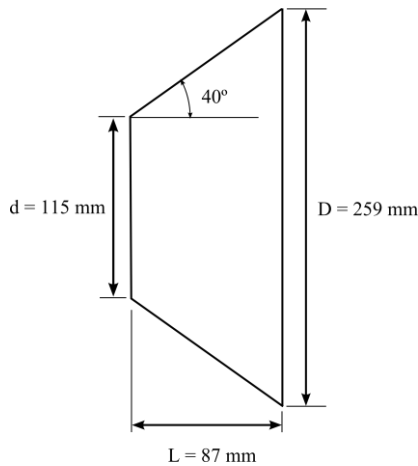

Figure 3. Dimensions of the diffuser and experimental apparatus.

The experiment was conducted in a wind tunnel (controlled by frequency inverter) operating at five different rotations, 400 rpm, 500 rpm, 600 rpm, 700 rpm and 800 rpm. Measurements of dynamic pressures were performed by means of a Pitot tube type L, with two pressure ports, having a diameter of 7.95 mm and a length of 30 cm. The apparatus also comprises a digital micro-manometer, a microcomputer, and the positioned Pitot tube installed on the wind tunnel and in front of the diffuser. The choice of Pitot tube occurred due to the initial purpose of determining the velocity distribution along the axis only, leaving aside the quantification and characterization of the vortices generated, otherwise it could be applied to laser Doppler anemometry (LDA) or particle image velocimetry (PVI), commonly used in turbulent flows. The velocity distribution on the axis for a given diffuser is a function only of space and dimensions, thus, for any values of speed imposed on the diffuser, the ratio of the velocity curve has the same shape.

The measurements were performed with the diffuser positioned externally to the wind tunnel, under the action of a flow in a jet of air. This configuration was chosen due to the fact that the cross section of the wind tunnel (310 mm x 310 mm) is insufficient to hold the body of the diffuser and avoids wall effects on the flow around the diffuser.

4. RESULTS AND DISCUSSION

The velocity values for each point along the longitudinal axis of the diffuser were obtained from a sample of 2000 measurements. The results, with uncertainty at 95% confidence, have error of $\pm 10^{-4}$ for measurements of pressure and velocity, which ensures adequate repeatability (Figueiredo, 2012). Figure 4 shows the velocity distributions calculated by the Eq. (5) compared with values obtained experimentally. In this graph, the diffuser is delimited by lines Inlet and Outlet thereby entrance of the diffuser is at 0.22 m and its exit at 0.30 m diffuser.

The velocity ratio from the furthest region from the diffuser (non-disturbed flow) to its minimum value appears differently from the actual case. From this point of minimum to the maximum point, the velocity distribution shows very good agreement with experimental results, diverging from the point of maximum to the region downstream of the diffuser.

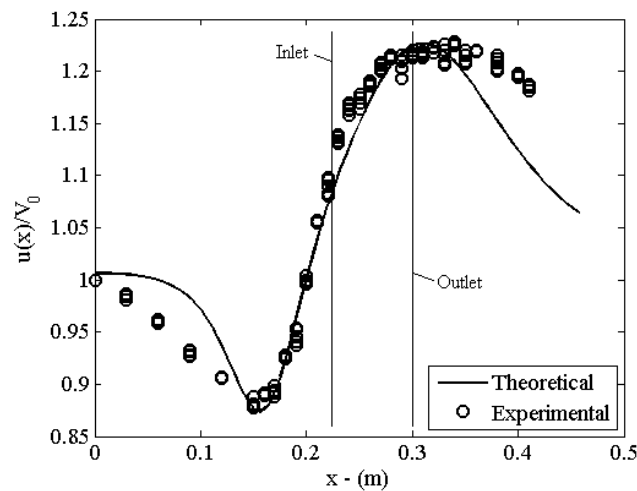

Figure 4. Comparative curve of the theoretical and experimental velocity ratios.

Figure 5 is a portion of the graph shown in Fig. 4, and corresponds to the internal region of the diffuser which shows, in detail, the behavior of the velocity profile in the internal region of the diffuser, where it is observed that the results obtained with the proposed model is in agreement. The value of the constant 'a' is the distance between the origin of the abscissa, which is also the first measurement point velocity, and the entrance of the diffuser. Thus, for the experiment performed, the value of 'a' was set to 0.223 m. The parameters in the simulation were considered $c_1 = 0.06$ m, $c_2 = 0.0$ m, $\xi_1 = 0.7$ and $\xi_2 = 1.1$. These values were obtained by comparison method from the computer routines implemented in the Matlab software that solved the equations which rule the problem, so that the curve obtained by the mathematical model, approaching to the maximum of the experimental curve. But as the problem in question still needs comparisons of results to other settings diffusers, it is possible that these constants obey a certain pattern according to the dimensions of these diffusers.

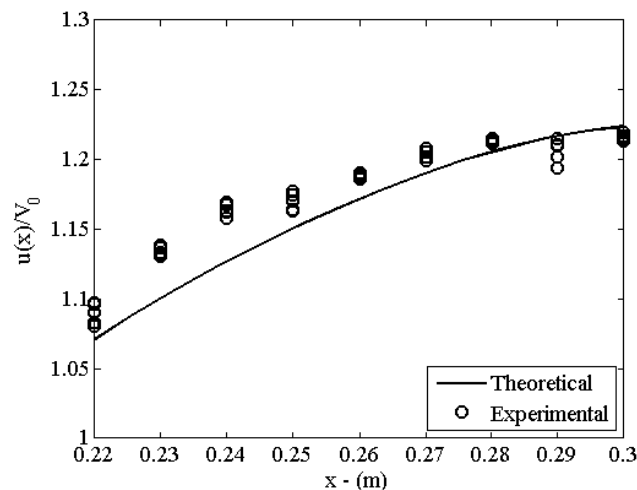

Figure 5. Velocity distribution internally to the diffuser.

Comparing the diffuser of this work with the work Ohya (2010) and Abe (2004), there is a difference in the velocity profile along the axis. The diffuser tested here shows a reduction in speed before reaching its input (pressure increase) differed from the comparative cases which show an acceleration of the flow from the free stream velocity to the entrance of the diffuser, followed by a deceleration, again reaching the free stream velocity. This difference probably is due to the opening angle of the diffuser tested ($\phi = 40^\circ$), which causes a blocking effect on the flow, where it should be noted that the optimal value for this angle is adopted as $\phi = 4^\circ$. In a diffuser, the flow expands along its inner wall, resulting in decreased speed and consequently an increase in the coefficient of pressure toward the exit of the diffuser (Abe, 2004), adverse pressure gradient. Based on this, even with a large opening angle, the velocity profile from the diffuser entry is similar to those diffusers which have r_a reduced, or increased followed by speed reduction.

To evaluate the effect of results obtained in this study on the theoretical power coefficient of a turbine diffuser, using the model described by Rio Vaz et al., (2012), given by:

$$C_p = \varepsilon 4\tilde{a}(1 - \tilde{a})^2 \quad (7)$$

where ε is the ratio of speed at the position where the turbine is to be installed in the diffuser, and is given by:

$$\varepsilon = \frac{u(x)}{V_0} \quad (8)$$

The factor induction at the axial plane of the \tilde{a} rotor can be written in function of the thrust coefficient C_T , such as:

$$\tilde{a} = \frac{1}{2} \left(1 - \sqrt{1 - C_T} \right) \quad (9)$$

Therefore, considering the speed ratio position 0.25m (Fig. 5), we have $\varepsilon = 1.17$. Figure 6 shows the effect of the diffuser on the power coefficient of the turbine. It is observed that the diffuser improves the efficiency of the turbine, and represents a technology that can be used in power generation systems small wind.

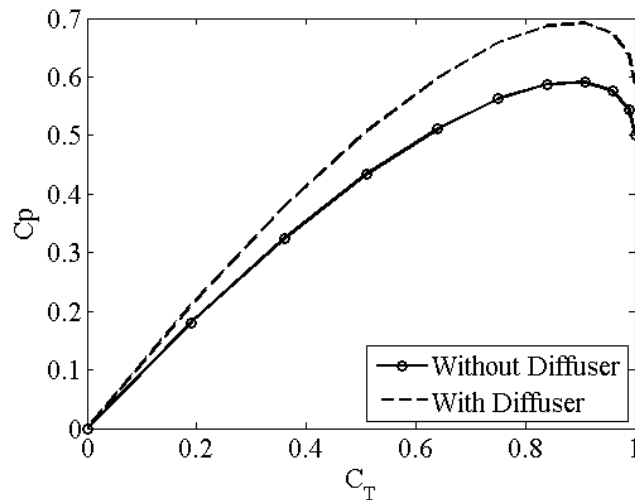

Figure 6. Power coefficient as a function of the thrust coefficient.

4. CONCLUSION

The velocity distribution along the axis of the diffuser obtained with the proposed model present a good agreement with experimental data. It is noteworthy that the internal region of the diffuser the velocity profile is very close to the actual case being the most important because it indicates the best position for positioning the wind turbine. For the diffuser tested in the present study highlights that the ratio of maximum speed occurs at 0.32 m of the axis, and the outlet zone of the diffuser is 0.30 m, that is, the biggest peak velocity is located externally to diffuser.

The blocking effect at the entrance of the diffuser opening angle is responsible for the elevated velocity profile (Fig. 4) which differs from cases with milder opening angles (Fig 7). Therefore, it is necessary, in principle, to use small opening angles ($\phi \approx 4^\circ$) in order to smooth the flow in the entry region of the diffuser preventing the increase of pressure and the consequent reduction in speed. Subsequently it will be seen that such condition is of extreme importance for installation in the region of the turbine inlet diffuser.

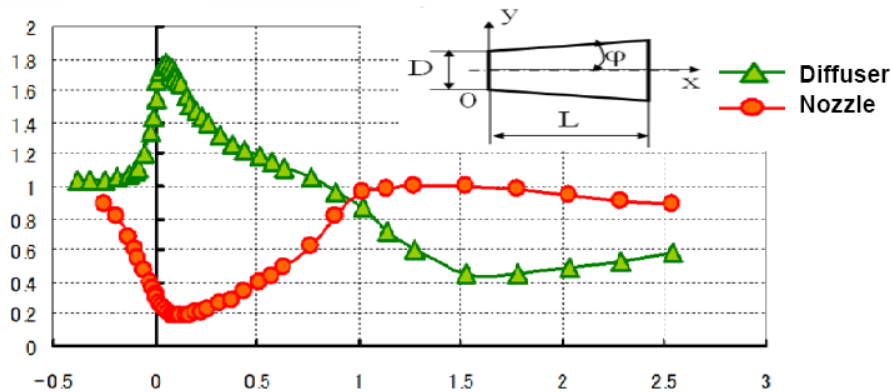

Figure 7. Velocity distribution in the diffusers with opening angle 4° (Ohya and Karasudani, 2010).

Ohya (2010) shows that for a diffuser with aspect ratio $r_a = 7.7$, the peak of ratio velocities is located inside the diffuser near its entrance. Based on the diffuser of the present work, aspect ratio $r_a = 0.75$, and Ohya (2010), it was found initially that r_a decreases, the point of maximum velocity shifts due to the entrance of the diffuser towards its exit.

In principle, it would be more convenient to install the turbine in the region near the exit of the diffuser, where the speed is the greatest. However, Fig. 8 shows that in the region of the diffuser outlet, the flow is turbulent and the turbine, in case, is installed in this region, which coincides with the maximum speed ratio, the turbine would lose the necessary lift for the utilization of available energy in the wind, and consequently, there would be a decrease in the turbine power coefficient.

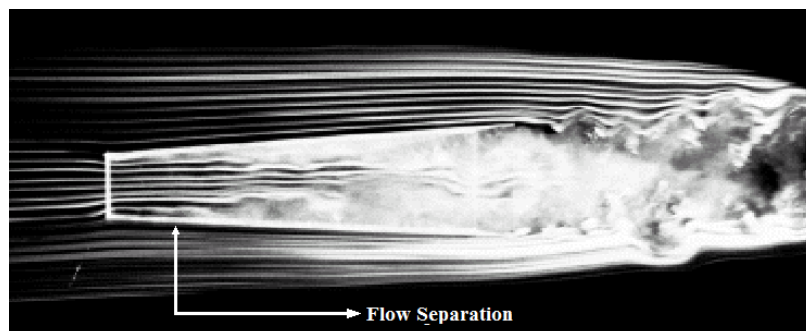

Figure 8. Streamlines of the flow around a diffuser (Ohya and Karasudani, 2010).

Therefore, the ideal position for installing turbine is near the entrance of the diffuser, because in this region the current lines are presented uniform (laminar flow), and avoids the turbulent flow formed by the separation of boundary layer on the inner wall diffuser, belt region, taking advantage of the speed gains without compromising the increased efficiency of the turbine.

In the design of wind turbines with diffusers, analytical models, as proposed in this work are considerably important, since these may be coupled to existing classical models, such as Glauert (1926), in order to supplement or improve them. Experimental data for other configurations of conical diffusers are currently being obtained to validate and refine the mathematical model proposed. It was also observed that the ratio between length and diameter of the diffuser inlet (aspect ratio) is closely related to the location of a maximum velocity ratio. Therefore, the proposed model has limitations, but it can be applied to DAWTs project, aiming at an improvement in the extraction of energy from the wind, resulting in increased efficiency.

5. REFERENCES

- Betz, A., 1926. *Wind-Energie und ihre Ausnutzung durch Windmuehlen*.
 Bussel, G. J. W. V., 1999. *An Assessment of the Performance of Diffuser Augmented Wind Turbines (DAWT's)*. 3th ASME/JSME Joint Fluids Engineering Conference, July 18-23, San Francisco, California, USA.
 Foreman, K. M. and Gilbert, B. L., 1979. "Technical Development of the Diffuser Augmented Wind Turbine" (DAWT) Concept, Wind Energy Innovative Systems Conf. Proc., Colorado Springs, Colorado, USA, pp. 121-134.
 Hansen, M. O. L; Sorensen, N. N. and Flay, R. G. J., 2000. "Effect of placing a diffuser around a wind turbine", Wind Energy, v. 3, pp. 207-213.

- Oman, R. A., Foreman, K. M. and Gilbert, B. L., 1975. "A Progress Report on the Diffuser Augmented Wind Turbine", Proc. 3rd Biennial Conference and Workshop on Wind Energy Conversion Systems, Washington, D. C., USA, pp. 819-826.
- Ohya, Y., and Karasudani, T., 2010. *A Shrouded Wind turbine generating high output Power with wind-lens technology* van Beveren, S.C., 2008. *Design of an urban wind turbine with diffuser*. Master thesis, Delft University of Tehnology, Delft, Netherland.
- Figueiredo, S. W. O., Silva, M. O., Lins, E. F., Vaz, J. R. P., 2012. *Estudo Experimental do perfil de velocidade em difusor cônico voltado para o projeto de turbinas eólicas*. VII Congresso Nacional de Engenharia Mecânica, São Luis, Maranhão, Brasil.
- Rio Vaz., D. A. T. D., Blanco, C. J. C., Mesquita, A. L. A., Pinho, J. T. *Uma abordagem matemática para o projeto de turbinas hidrocínéticas de eixo axial*. VII Congresso Nacional de Engenharia Mecânica, São Luis, Maranhão, Brasil.
- Abe, K., Ohya, Y. 2004. "An Investigation of Flow Fields Around Flanged Diffusers Using CFD". Journal of Wind Engineering and Industrial Aerodynamics, Vol. 92, pp. 315-330.
- Glauert, H., 1926. *The Elements of Aerofoil and Aircrew Theory*. Cambridge University Press, London, UK

6. RESPONSIBILITY NOTICE

The authors are the only responsible for the printed material included in this paper.