

## ANALYSIS OF AVOIDABLE AND UNAVOIDABLE EXERGY DESTRUCTION IN A COMBINED CYCLE PLANT

Dimas José Rúa Orozco<sup>1</sup>, [dimas.rua@hotmail.com](mailto:dimas.rua@hotmail.com)

Oswaldo José Venturini<sup>1</sup>, [osvaldo@unifei.edu.br](mailto:osvaldo@unifei.edu.br)

Jose Carlos Escobar Palacio<sup>1</sup>, [jocesobar@gmail.com](mailto:jocesobar@gmail.com)

<sup>1</sup>Universidade Federal de Itajubá, Av. BPS, 1303, Itajubá-MG, 37500-903.

**Abstract.** In this paper the thermoeconomic diagnosis of thermal systems for power generation is proposed aiming the identification of the elements of the cycle (turbines, compressors, heat exchangers, etc.) with an abnormal behavior and consequently causing fuel over-consumption for the same level of power production. Furthermore, those anomalies (also called malfunctions) have not only economical, but most often, environmental implications. Such malfunctions are expressed as irreversibilities of a system, that are quantified through the exergetic analysis. Thus, the purpose of thermoeconomic diagnosis is to identify and act over those components that are destroying exergy (due to a malfunction) and to return them to their optimal operational state after maintenance. However, not all the exergy destruction can be avoided, so that one can divide the exergy destroyed in two types: the unavoidable and avoidable exergy destruction. Only latter kind of exergy destruction deserves serious efforts to achieve savings in fuel consumption. This paper presents an analysis of a combined cycle to identify and quantify the avoidable exergy destruction, and how this type of exergy is affected by the presence of malfunctions associated with each equipment and malfunctions induced by the other components of the cycle.

**Keywords:** Thermoeconomic diagnosis, Avoidable exergy destruction, Malfunction.

### 1. INTRODUCTION

Today the thermoelectric plants are being questioned because of their high production of pollutants. This is one of the most important point to be considered when dealing with power generation worldwide. Especially when taking into account that the demand for electricity globally grew 2.7% between 1980 and 1997, and is expected to maintain a yearly growth rate of at least 1.8% until 2020 (Correas, 2001).

It is well known, that emissions can be reduced by improving the energy efficiency of the power plants, what means the production of the same power with lower fuel consumption, and consequently less pollutant emissions in the exhaust gases to the atmosphere.

Another way to reduce the emissions is to use clean energy, but the use of fossil fuels is expected to continue on an high level until at least 2050 (CEC, 2007), because in spite of having lower environmental impact, the renewable sources have higher costs per installed kW, ensuring that fossil fuel plants will have many years ahead.. Thus, there is a need to improve the technologies used in the thermal generation installations. With this object the information technology can be used to monitoring these generation processes and to assure that they will always operate with a high efficiency. With the data obtained, with the help of computational tools and using technical analysis the efficiency of these plants can even be improved. Among the methodologies that help achieving this goal one can find the thermoeconomic diagnosis. This methodology measure and interprets the signs that indicate a presence of a malfunction on an equipment of the system. Thermoeconomic diagnosis strategies have been the basis of many papers presented during the 80's by many authors (Usón, 2011). The goal of the diagnosis is to identify the equipment, in a production system, that causes deviations in fuel consumption and then estimate the amount of exergy destroyed in the system, and that can be retrieved with the corrective actions on the elements of the thermoelectric plant.

### 2. AVOIDABLE / UNAVOIDABLE EXERGY DESTRUCTION AND ITS IMPORTANCE IN THE THERMOECONOMIC DIAGNOSIS

The Exergy destruction  $E_D$  can be divided into two parts: the unavoidable and avoidable exergy destruction (Tsatsaronis and Park, 2002)

$$E_D = E_D^{UN} + E_D^{AV} \quad (1)$$

The unavoidable exergy destruction  $E_D^{UN}$  is always present in a component used in a system due to technological limitations, such as availability and cost of materials (Kelly et al., 2009). For example, for a heat exchanger, its effectiveness can be increased by increasing the heat transfer area, but this would entail a higher equipment cost. The

avoidable part of exergy destruction potentiates the possible efficiency improvement for a given system component (Torres and Valero, 2008).

The importance of quantifying these two types of Exergy destruction is that the thermoeconomic diagnosis should focus only on the avoidable one. For that, it is necessary to differentiate which part of the avoidable exergy destruction is due to the irreversible characteristic of the specific component (intrinsic malfunctions) and which part is due to external conditions acting over the component (induced malfunctions) (Kelly et al, 2009)

### 3. DESCRIPTION OF COMBINED CYCLE FOR CASE STUDY

The development of this work is based on a study case. So, a combined cycle with gas turbine and steam turbine was simulated, using the commercial software GateCycle™ 5.51 with the aim of calculating the value of the avoidable and unavoidable components of exergy destruction. The scheme of the plant under study is shown in Fig.1. The plant consists of a gas turbine (GTD1) with a net capacity of 228 MW. The turbine exhaust gases are used in a heat recovery steam generator (HRSG), which is composed by an evaporator (EVAP1), a superheater (SPHT1) and an economizer (ECON1). The HRSG can produce steam at 8000 kPa and 562°C. This steam is expanded in a steam turbine (ST1) to a pressure of 20 kPa. The equipments that complement the plant are the condenser (CND1) and the feed pump (PUMP1), in addition to a mixer (M1) and a makeup water tank (MU1).

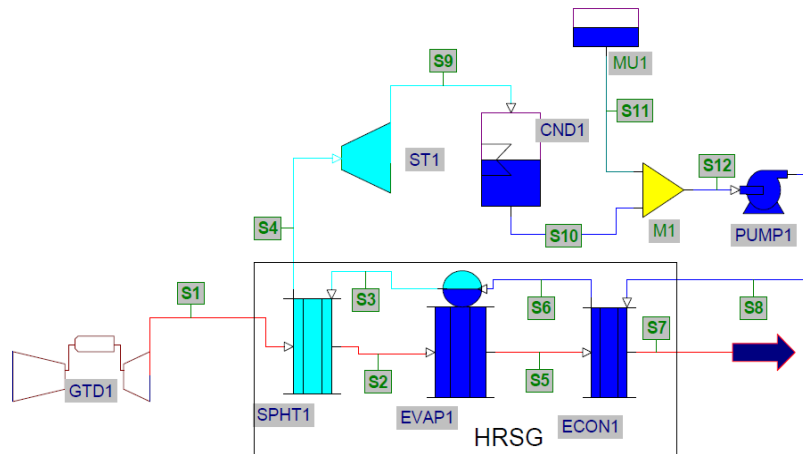

Figure 1. Configuring the combined cycle plant considered.

The parameters used in the simulation are presented in Tab.1 for each stream of the cycle. These streams are shown on Fig. (1)

Table 1. Physical parameters of the flows for the combined cycle simulated.

STREAM	S1	S2	S3	S4	S5	S6	S7	S8	S9	S10	S12
<b>T (°C)</b>	625	524	295	562	330	289	190	61	60	60	60
<b>P (kPa)</b>	101.32	101.32	8000	8000	101.32	8000	101.32	8000	20	20	20
<b>Flow (kg/s)</b>	608.56	608.56	92.92	92.92	608.56	92.92	608.56	92.92	92.92	92.92	92.92

### 4. ANALYSIS OF THE RESULTS

To estimate the avoidable exergy destroyed, the first thing done was to determine the extent of its counterpart: the unavoidable exergy destruction. It was used the concept of Law of Saving-Investment (Torres and Valero, 2008) together with the definition of unavoidable destroyed exergy. For its estimation it was considered that  $E_D^{UN}$  is the Exergy destruction that cannot be avoided due to factors such as technical limitations and costs of investment. Thus, it is possible to find the exergy destroyed if it is calculated for the case in which the cost (Z) tends to infinity, as shown in Eq. (2).

$$E_D^{UN} = \lim_{z \rightarrow \infty} E_D \quad (2)$$

The cost of investment for equipment is determined by several variables, but mainly to the cost of materials. For heat exchangers it has been selected as a physical parameter variation when costs tend to infinity. That parameter is the heat transfer area:

$$(\lim_{A \rightarrow \infty} Z) \rightarrow \infty \tag{3}$$

Fig. 2 shows the relationship between the exergy destroyed and the heat transfer area for SPHT1. The unavoidable exergy destroyed is the asymptote of the curve, when the heat transfer area of the heat exchanger tends to infinity. In this case the value of the destroyed exergy per unit of exergy of the product is 0.1290 kW/kW.

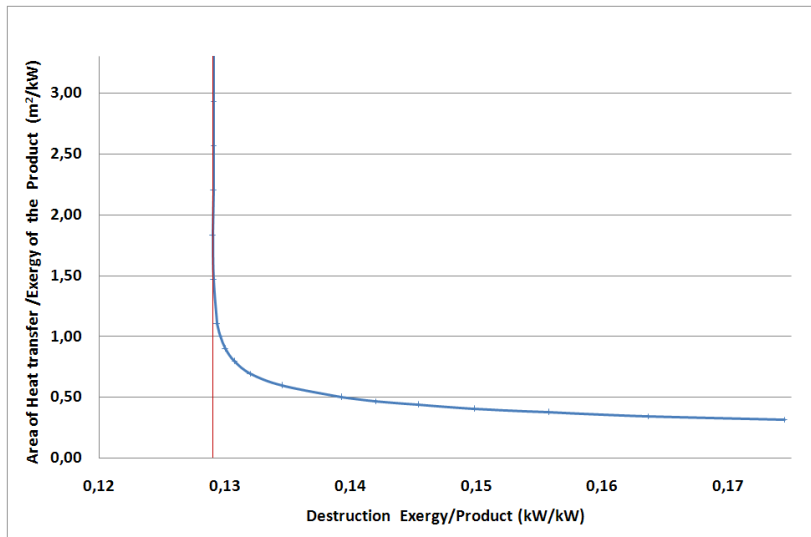

Figure 2. Relationship between Exergy destruction and the heat transfer area for the superheater (SPHT1).

The simulation shows the process and the influence of the intrinsic and the induced malfunctions, for various cases, for calculate the exogenous and the endogenous avoidable exergy destruction. Table 2 shows the exergy destruction for each component of the cycle, in terms of the malfunctions of EVAP1 and SPHT1. The malfunctions were simulated as a change in the effectiveness of these heat exchangers.

Table 2. Exergy destroyed for each cycle component as a function of the effectiveness of the superheater (SPHT1) and the evaporator (EVAP1)

EFFECTIVENESS		EXERGY DESTRUCTION (KW)					
SPHT1	EVAP1	SPHT1	EVAP1	ECON1	CND1	ST1	PUMP1
0.850	0.850	7571.751	15463.704	11909.294	17787.598	15966.171	118.902
0.850	0.825	7523.476	15495.248	12325.878	17451.428	15824.911	116.492
0.850	0.800	7471.723	15512.441	12747.880	17107.480	15679.780	114.045
0.825	0.850	7617.230	15780.515	11900.548	17894.254	15905.499	120.016
0.825	0.825	7567.644	15722.563	12404.267	17559.101	15766.693	117.605
0.825	0.800	7513.693	15736.092	12833.244	17210.865	15620.990	115.117
0.800	0.850	7653.660	16106.741	11889.847	18001.357	15843.874	121.140
0.800	0.825	7602.999	15954.201	12484.186	17667.558	15706.908	118.727
0.800	0.800	7547.916	15965.991	12919.551	17314.647	15561.305	116.196

Figure 3 (a) shows the exergy destroyed in SPHT1, when malfunctions occur in the EVAP1 and SPHT1. It is possible to observe that a decrease in the effectiveness of SPHT1 cause an increase in the exergy destroyed. However, a decrease in the effectiveness of the evaporator causes a reducing in the SPHT1 exergy destroyed, due to a reduction in the steam produced.

Figure 3 (b) shows the relationship between the exergy destroyed and the product in the SPHT1, when malfunctions occur in the EVPA1 and the SPHT1. It becomes clear that malfunctions in SPHT1 and EVAP1 really cause inefficiency in SPHT1.

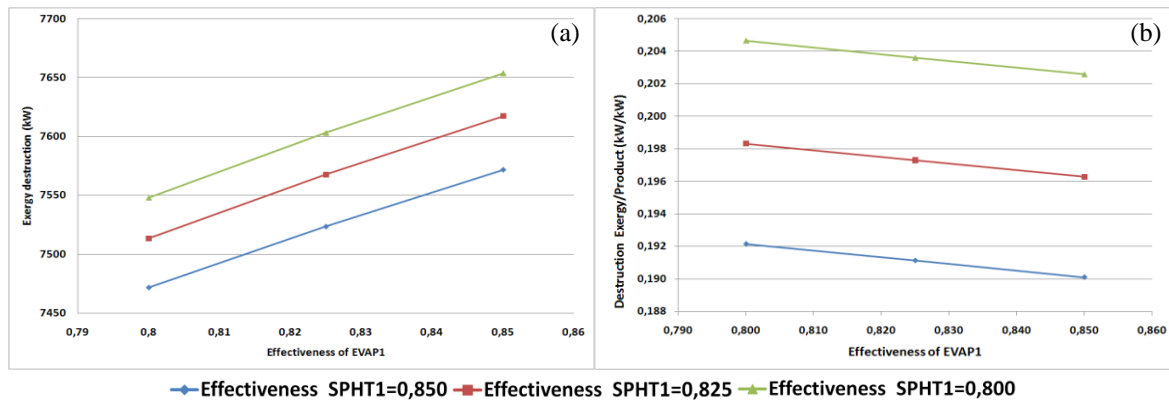

Figure 3. (a) Exergy destruction and (b) Exergy destruction/ exergy of product at the superheater (SPHT1) depending of the evaporator effectiveness (EVAP1) and the superheater effectiveness (SPHT1)

Figure 4 (a) shows the exergy destroyed in EVAP1, when malfunctions occur in the EVAP1 and SPHT1. It is possible to observe that a decrease in the effectiveness of SPHT1 cause an increase on the exergy destroyed in the EVAP1.

Figure 4 (b) shows the relationship between the exergy destroyed and the product in the EVAP1, when malfunctions occur in the EVPA1 and the SPHT1. It becomes clear that the malfunctions in SPHT1 and EVAP1 in fact also cause inefficiency in EVAP1.

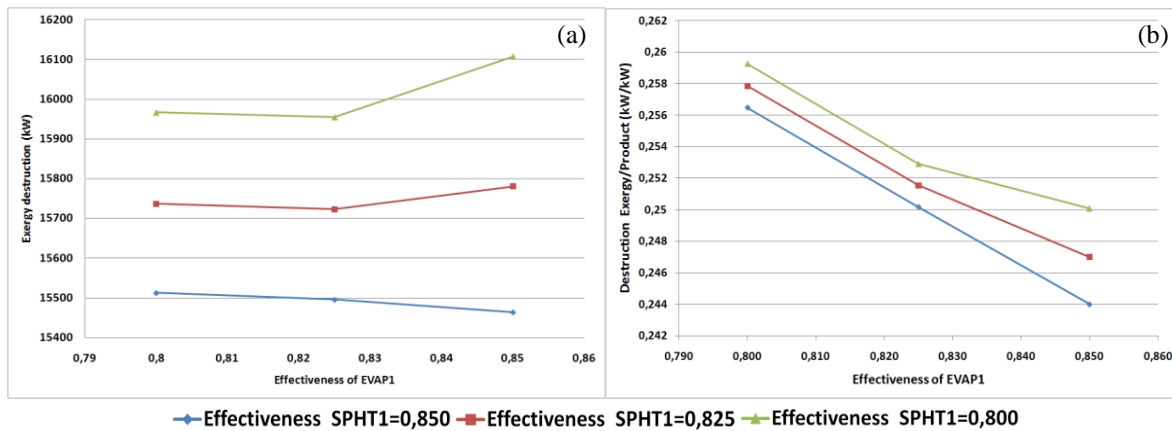

Figure 4. (a) Exergy destruction and (b) Exergy destruction/ exergy of product at the evaporator (EVAP1) depending on the evaporator effectiveness (EVAP1) and the superheater effectiveness (SPHT1)

Figure 5 shows that a malfunction in the evaporator causes a considerable increase in the exergy destroyed on the ECON1, while its influence of the SPHT1 can be considered small.

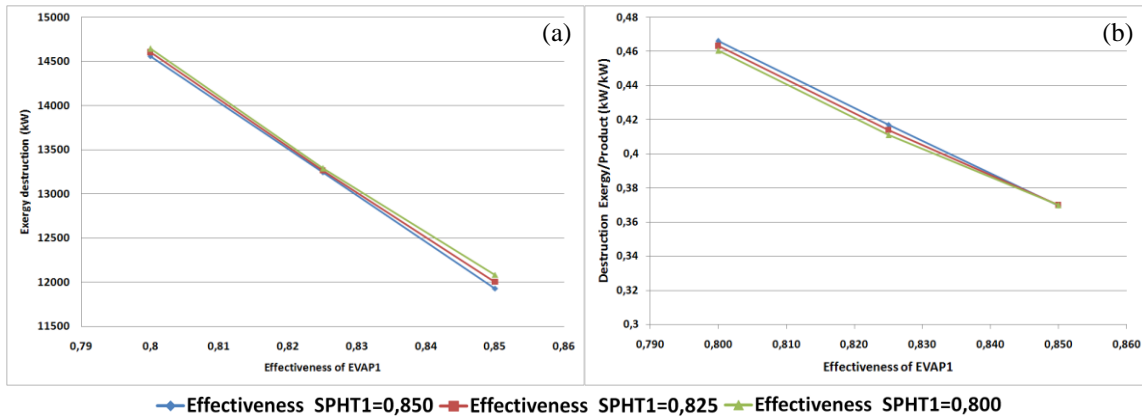

Figure 5. (a) Exergy destruction and (b) Exergy destruction/ exergy of product at the Economizer (ECON1) depending on the evaporator effectiveness (EVAP1) and the superheater effectiveness (SPHT1)

Figure 6 shows the relationship between the exergy destroyed in the condenser and malfunctions in the evaporator and superheater. It is possible to observe that a malfunction in the SPHT1 causes an increase in the overall destroyed exergy in the condenser, while a malfunction in the evaporator contributes to a reduction in the exergy destroyed in the condenser. The interrelation between components behavior highlights the difficulties to conduct a thermoeconomic diagnosis, since the effects of induced malfunctions can be positive or negative. Similar considerations can be made from Figures 7 and 8, which shows the exergy destroyed for ST1 and PUMP1 due to the presence of malfunctions in SPHT1 and EVAP1.

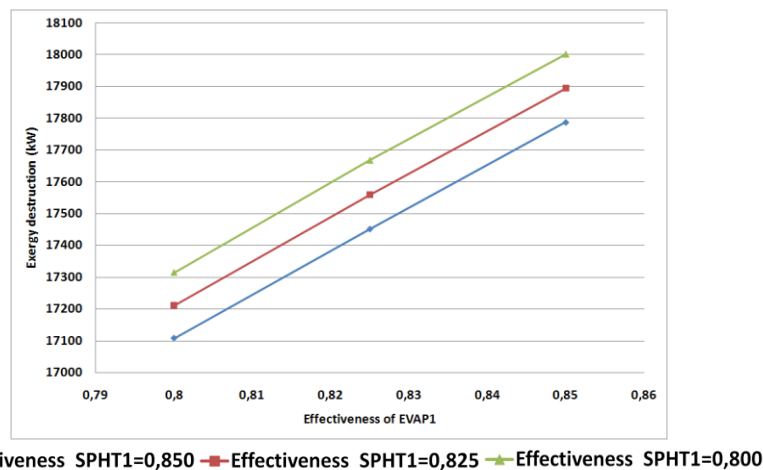

Figure 6. Exergy destruction at the Condenser (CND1) depending on the evaporator effectiveness (EVAP1) and the superheater effectiveness (SPHT1)

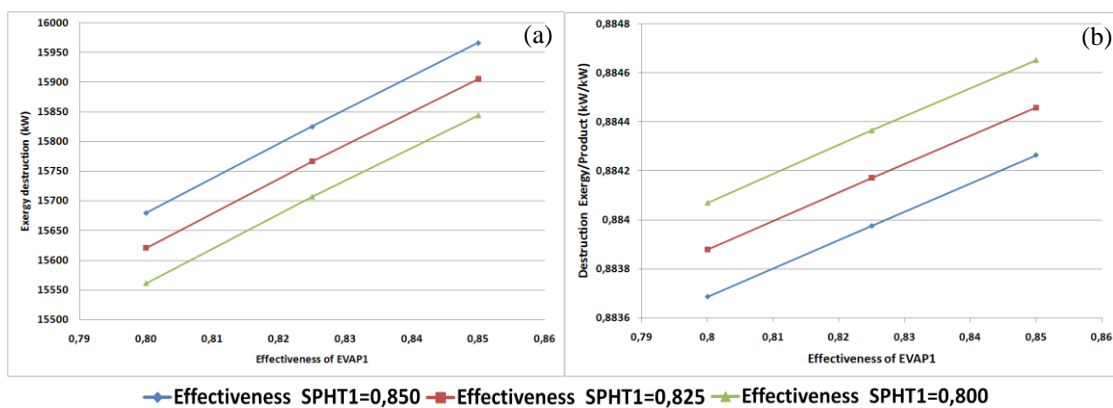

Figure 7. (a) Exergy destruction and (b) Exergy destruction/ exergy of product at the Steam Turbine (ST1) depending on the evaporator effectiveness (EVAP1) and the superheater effectiveness

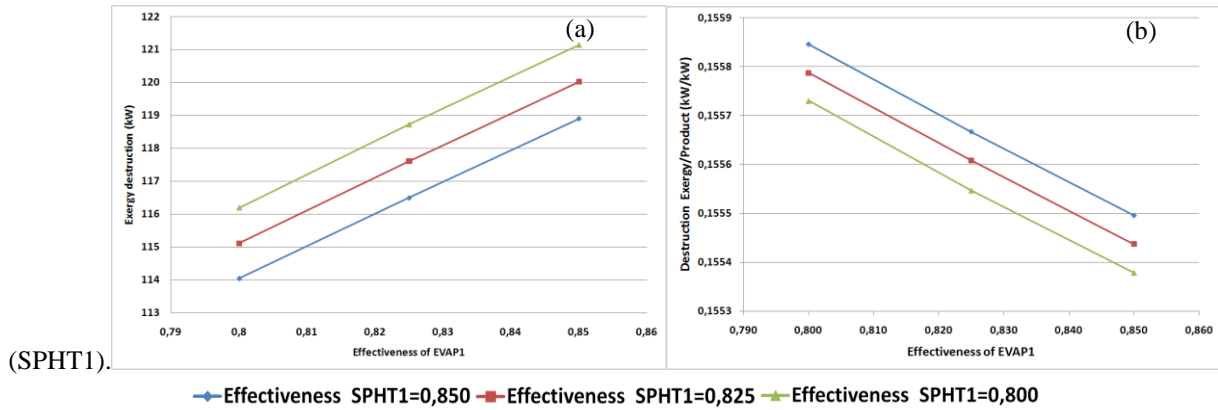

Figure 8. (a) Exergy destruction and (b) Exergy destruction/ exergy of product at the feed pump (PUMP1) depending on the evaporator effectiveness (EVAP1) and the superheater effectiveness (SPHT1).

Figure 9 shows the effects caused by malfunctions in SPHT1 and EVAP1 on the combined cycle net power. It is noted that both malfunctions cause a decrease in the net power and in the thermal efficiency of the cycle. It is also possible to observe that a malfunction in the evaporator is causing a higher impact on the changes in net power and destroyed exergy of all devices. This is because the evaporator set the steam and water flow through the whole cycle, exerting a direct influence on all devices of the cycle. For its part, the superheater, only have control over the superheater's steam outlet temperature (Gay et al., 2004).

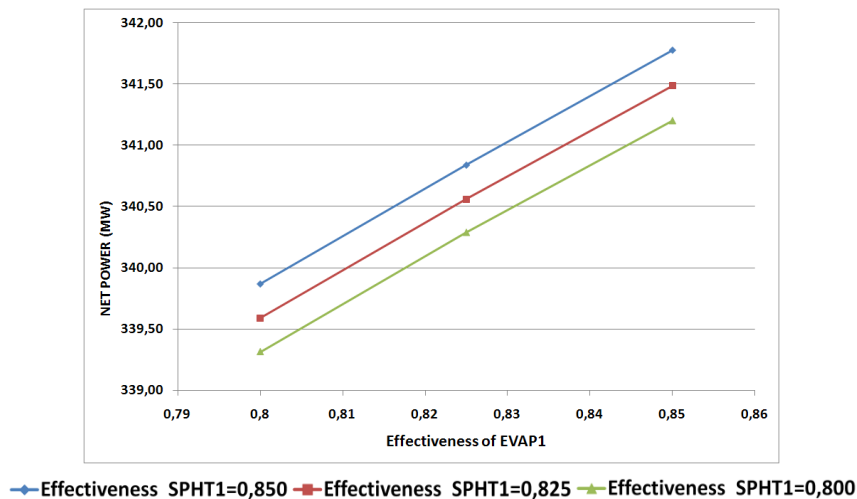

Figure 9. Net Power depending on the evaporator (EVAP1) effectiveness and the superheater (SPHT1) effectiveness.

From Figure 10, considering the reference condition (EVAP1 and SPHT1 effectiveness equal to 85%) for the SPHT1, it is possible to observe that 84.41% of the exergy destroyed corresponds to unavoidable exergy destruction and only 19.59% corresponds to avoidable one.

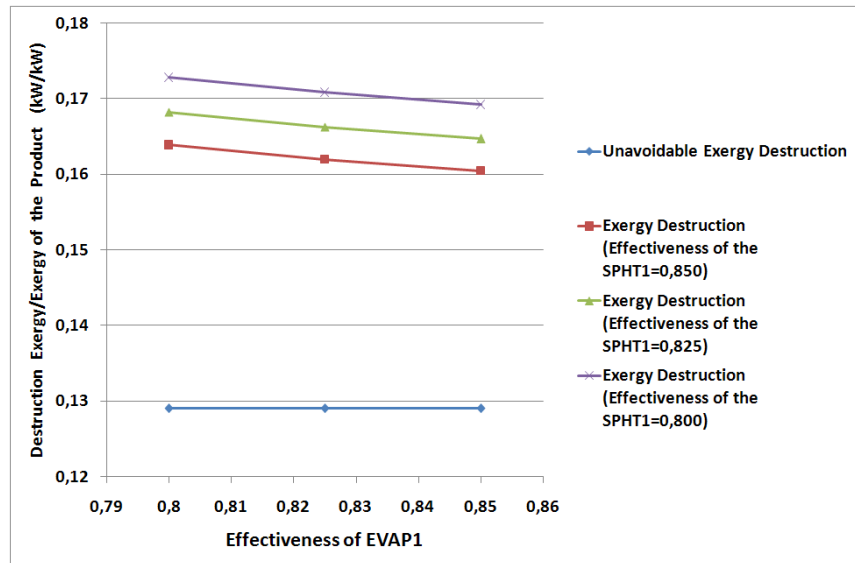

Figure 10. Destruction exergy/exergy of product at the Superheater (SPHT1) depending on the evaporator effectiveness (EVAP1) and the superheater effectiveness (SPHT1).

Considering the presence of malfunctions in the two devices: Superheater, whose effectiveness was reduced from its nominal value (85.0%) to 82.5% in order to simulate a malfunction, and Evaporator, whose effectiveness (due to a malfunction) was reduced from its nominal value (85.0%) to 80.0%, it can be observed that the exergy destroyed for the Superheater is increased by 4.825% due to the intrinsic and induced malfunctions. The distribution of exergy destruction of the Superheater under these conditions is presented in figure 11.

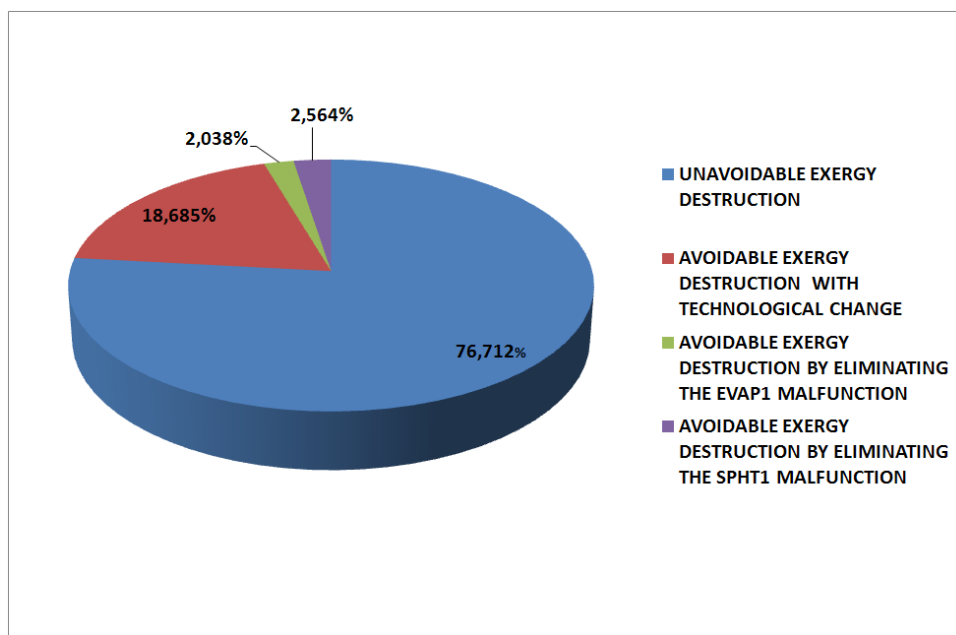

Figure 11. Percentage of the distribution of exergy destruction of the SPHT1 for EVAP1 Effectiveness = 80,0% and Effectiveness of the SPHT1=82,5%

## 5. CONCLUSIONS

To calculate the exergy destroyed of a component of a thermal cycle, it should be considered the influence of other components of the cycle, as is evident from the results obtained for the induced exergy destroyed.

The model developed replicates the operating conditions of the real thermal cycle, and can be used when comparing the deviations in fuel consumption caused by each component of the system.

It is possible to calculate the unavoidable exergy destruction in each component using parameters, such as dimensions, maximum or minimum allowable temperature, steam quality allowed, etc. This will introduce the concept of maximum avoidable exergy destroyed.

Considering the conditions analyzed, the evaporator is the component that produce the higher major impact on the exergy destruction on the others elements of the system.

For the superheater over 76% of its irreversibilities cannot be avoided by any means, and only 4.6% of the irreversibility can be avoided by corrective maintenance routines for the given case.

## 6. ACKNOWLEDGEMENTS

The authors express their thanks to the Fundação de Amparo à Pesquisa do Estado de Minas Gerais (FAPEMIG), to the Coordenação de Aperfeiçoamento de Pessoal de Nível Superior (CAPES) and to the Conselho Nacional de Desenvolvimento Científico e Tecnológico (CNPq) for the financial support.

## 7. REFERENCES

- CCE. - Comissão das Comunidades Europeias, 2007, Comunicação da Comissão ao Conselho e ao Parlamento Europeu (produção sustentável de eletricidade a partir de combustíveis fósseis: rumo a emissões quase nulas do carvão após 2020). Bruxelas.
- Correas, L.C., 2001. Diagnóstico Termoeconómico de la Operación de un Ciclo Combinado, Ph.D. thesis, Dpto. Ing. Mecánica, Univ. de Zaragoza, Espanha.
- Gay, R.R., Palmer, C.A., Erbes, M.R., 2004, Power Plant Performance Monitoring. R-Squared Publishing, Woodland & CA ,pp. 235-247.
- Kelly, S., Tsatsaronis, G. and Morosuk, T., 2009. Advanced exergetic analysis: Approaches for splitting the exergy destruction into endogenous and exogenous parts. *Energy*, Vol. 34, pp. 384–391.
- Torres, C. and Valero, A., 2008. Exergoeconomic Cost Evaluation based on Irreversibility Decomposition Analysis. CIRCE. Centro de Investigación de Recursos y Consumos Energéticos University of Zaragoza, Spain.
- Tsatsaronis, G. and Park, M.H., 2002. On avoidable and unavoidable exergy destructions and investment costs in thermal systems. *Energy Conversion and Management*, Vol. 43, pp. 1259–1270.
- Usón, S. and Valero, A., 2011. Thermo-economic diagnosis for improving the operation of energy intensive systems: Comparison of methods. *Applied Energy*, Vol. 88, pp. 699–711.

## 8. RESPONSIBILITY NOTICE

The authors are the only responsible for the printed material included in this paper.