

Beamforming Technique Applied to the Study of Acoustic Effect in Damping Treatment

William D'Andrea Fonseca, willdfonseca@yahoo.com.br

Marcio Furukava, furukava@emc.ufsc.br

Samir N. Y. Gerges, samir@emc.ufsc.br

Mechanical Engineering Department, Federal University of Santa Catarina, Campus Universitário Trindade, Florianópolis, SC, Brazil

Robert P. Dougherty, rpd@optinav.com

OptiNav, Inc., 4176 148th Ave. NE, Redmond, WA 98052, USA

Damping materials such as Asphaltic Melt Sheet and LASD material (Liquid Applied Sprayable Damper) are used to reduce vibration levels within passenger vehicles. The performance of the acoustic package depends on the position of application and the thickness of the material. These parameters must be optimized to ensure the best performance with lower cost and weight. However, the effect of this positioning on sound radiation has not been evaluated. This article presents a study of sound radiation behavior in an ideal prototype passenger vehicle with optimized damping treatment using beamforming techniques. Beamforming was applied before and after application of the damping material. This aims to elucidate the regions of higher sound radiation and the noise reduction after damping treatment.

Keywords: beamforming, acoustics, damping material, viscoelastic, vibration

1. INTRODUCTION

At present the automobile industry has a great challenge: develop high quality, quieter and cheaper vehicles using correctly environmental materials and manufacturing procedures, which is a requirement from worldwide environmental agencies. Thus, NVH (Noise, Vibration and Harshness) engineers have to develop new materials for vehicle sound packages that meet these requirements. Usually these materials are insulators and dampers.

Damping materials are used to reduce vibration levels and noise radiated from body panels. Currently, there are two types of damping materials used for structural passive control: free layer dampers and constrained layer dampers. The first one is used more because of its lower cost and was therefore chosen for this study.

The particular material used was a Liquid Applied Sprayable Damper (LASD), which offers several advantages in an industrial setting that include adequate damping performance, automated application, simplicity of storage and transportation, and the possibility to consolidate internal and external application using the same material.

Structural vibration behavior is studied to identify the optimal region to apply damping material. In the current work, a prototype of an ideal vehicle was mapped to identify regions associated with higher levels of vibration energy, and damping material was applied in those locations. A 39% reduction of vibration level was obtained. The acoustical effect of this application must be evaluated as a separate measurement.

Beamforming is an acoustic imaging technique. It was used in this project to map the sound source distribution with and without damping material. The work was motivated by questions about the effects of insertion of mass and stiffness on sound radiation. These changes can produce regions of non cancellation in finite plates such as the floorpan.

2. DAMPING TREATMENT OVERVIEW

Low noise and vibration levels inside the cabin of passenger vehicles are major requirements for customer satisfaction. These can be obtained by a number of means classified as active, passive, and semi-active methods. However, the advance of active and semi-active methods for passenger vehicles has been slow because of their high cost and sensitivity. These methods do not ensure the robust performance which is required for the system.

Thus, the traditional method to control airborne noise and structure-borne vibration in passenger vehicles is passive and called the acoustic package. It comprises absorbers, barriers, mufflers, silencers, and isolator and damping materials, Fig. 1.

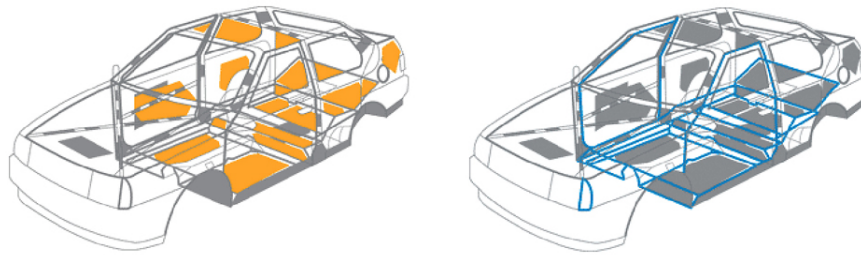

Figure 1: Sketch of locations of an acoustic package.

Sometimes it is possible to reduce unwanted vibration in resonant frequencies by changing the mass and the stiffness of the system for the same excitation frequency. In most cases, however, the use of damping materials to dissipate vibrations for a large range of frequency is indispensable. The technology of passive damping materials has been used since the early 1960s in the non-commercial aerospace industry. Advances in material manufacturing technology and more efficient analytical and experimental tools to describe dynamical behaviors made possible the wide use of these materials in the commercial aerospace and automotive industries (Rao, 2003).

Viscoelastic materials are widely used in passenger vehicles. These materials present characteristics of both a viscous fluid, such as bitumen, and an elastic solid, such as a spring. That is, the material returns to its original shape after being stressed, but does it slowly enough to oppose the next cycle of vibration. In these materials, damping refers to the extraction of mechanical energy from a vibrating system, usually by conversion into heat. This conversion caused by viscoelastic material happens through different physical processes depending on the material design. There are two different design classifications: free-layer damping treatment and constrained-layer or sandwich-layer damping treatment.

Free-layer damping treatment is one of the simplest designs for material application, Fig. 2 a. In this approach, the material is attached to the surface using a bonding agent or the structure may be placed into a heater where the material melts over the structure. In this configuration the energy is dissipated when the base structure is under a flexural stress and the viscoelastic material deforms in extension and compression in planes parallel to the base, Fig. 2 b (Rao, 2003).

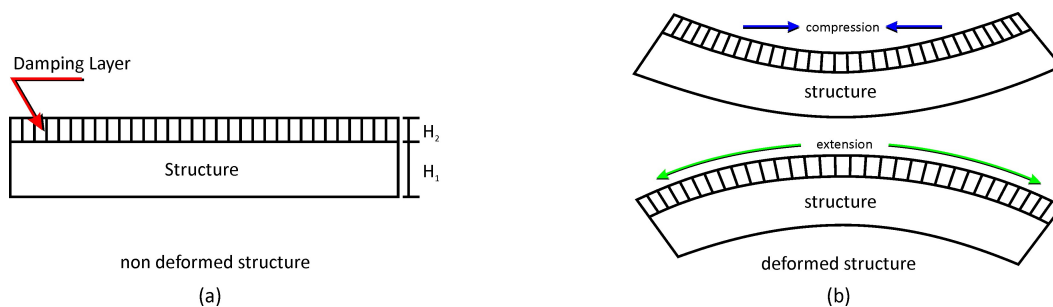

Figure 2: (a) Damping material applied on structure; (b) Bending resulting from vibration.

Figure 3a illustrates the design of a constrained-layer damping treatment. This consists of a narrow viscoelastic layer between two outer elastic (metal) layers. The energy in this configuration is dissipated in a different way. When the base structure is under a bending vibration, the metal layer will constrain the viscoelastic material and force it to deform in shear, Fig. 3b. This way of damping treatment is more efficient than the unconstrained-layer, but this efficiency is balanced by a greater complication in analysis and application (Nashif *et al.*, 1985).

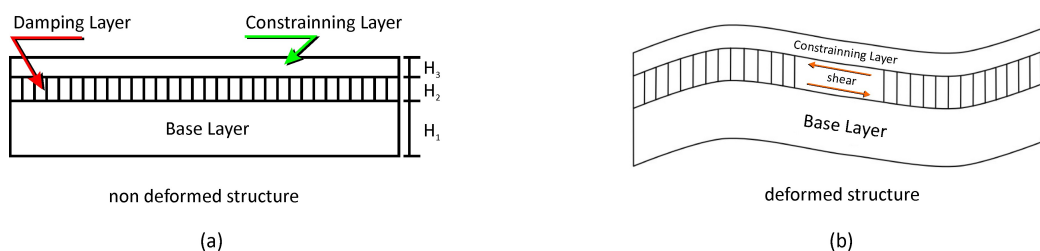

Figure 3: (a) Constrained-layer damping material design; (b) Bending resulting from vibration.

To design an effective noise and vibration control treatment, it is essential to understand the influences of environmental conditions on damping properties of viscoelastic materials. These properties depend significantly on factors such as

temperature, frequency of excitation, pre-load, dynamic load and humidity. However, this variation with environmental conditions should be treated as an advantage and not a disadvantage, because it permits some design flexibility for noise and vibration control. For this reason a brief discussion about the most important environmental effects is provided.

Temperature is usually the most important environmental factor affecting the dynamic properties of damping materials. In Figure 4, it is possible to see four distinct regions of material's behavior under influence of temperature variation. The first one is glassy region, where the material has the maximum value of dynamic stiffness, E , but very low damping, η . In the second region, called transition region, the dynamic stiffness decreases rapidly with increasing temperature, while the damping has its maximum value. The rubbery region is the third one; here both dynamic stiffness and damping have low values and vary slowly with temperature. The flow region is where the material continues to soften, i.e. the dynamic stiffness continues decrease as temperature increases while the damping reaches very high values (Rao, 2003; Nashif, 1985).

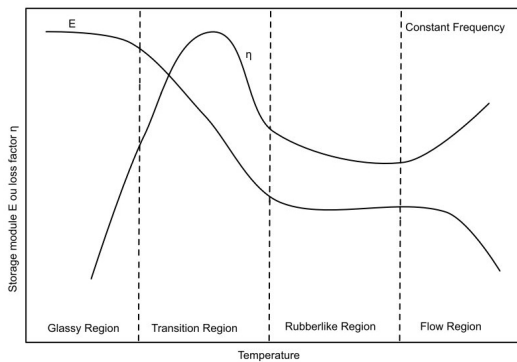

Figure 4: Variation of the storage modulus and loss factor with temperature, (Nashif *et al.*, 1985).

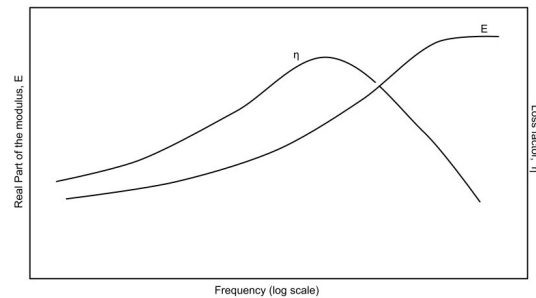

Figure 5: Variation of the real part of dynamic stiffness and damping with frequency, (Nashif *et al.*, 1985).

The effect of frequency is shown in Fig. 5, where it is possible to see the effect of frequency on damping properties for a large range of frequency. An examination of Fig. 5 reveals that it is qualitatively inverse of the Fig. 4, but to a lesser degree; that is, it takes several decades of frequency to reflect the same change of behavior as a few degrees of temperature. This phenomenon is one of the most important aspects of viscoelasticity theory. (Nashif *et al.*, 1985).

Traditionally, the damping material is applied on the door, roof, dash, floor and cab back panels of passenger vehicles, as shown in Fig. 6 and Fig. 7, because the interior soundfield depends on the vibration of the body panels which enclose this interior. The body panels are considered a group of finite plates that constitute the cabin. To control the interior noise, it is necessary to reduce the vibration levels on the panels. According to Beranek (1988), the main effects of damping treatment on panels are reduction of vibration amplitude at resonance, decrease of noise generated from repeated impact, decrease of structural waves propagation on panel and increased of acoustic isolation above critical frequency.

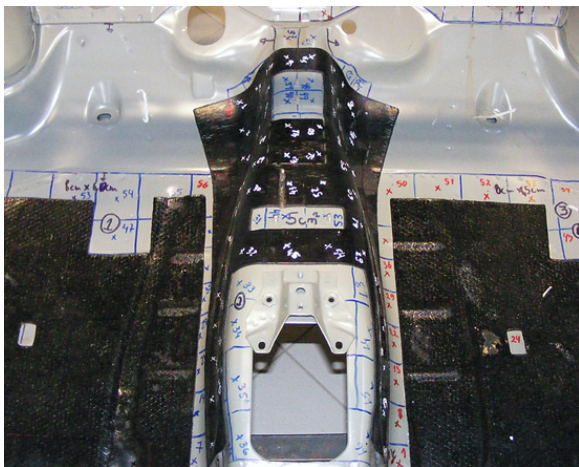

Figure 6: Damping material applied on body panels.

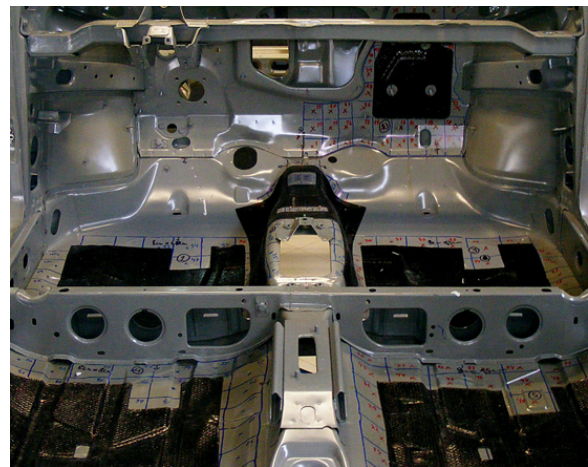

Figure 7: Asphalt melt sheet applied on floorpan.

Usually, the damping used on body panels is asphalt melt sheet dampers. This material has been in use for damping treatment in automotive applications since the 1950's and is still widely used today. The dampers are pre-manufactured at target weight from asphaltic-based compounds and supplied to the assembly line in stacks of individually shaped parts. It is still in use because it has low material cost.

These asphaltic materials generally present some operational problems. Their high flow under high temperature restricts the use of these to horizontal surfaces. The dampers exhibit the lowest level of damping performance relative to the others materials. However, while the performance is low, they have the lowest cost compared to the others materials applied to reduce floorpan vibration levels. In typical passenger vehicle applications these materials are applied over the majority of the body panel area, and the total weight of all material applied is up to 10 Kg per vehicle (Lilley *et al.*, 2001).

Damping material for passenger vehicle body, floor and dash panels have been undergoing rapid advancements in recent years. One of these advancements is a new sprayable form called Liquid Applied Sprayable Damper (LASD). LASD materials have three different chemistry bases: epoxies, sprayable asphaltics and water-base epoxies. The last one is more common for this application.

The primary problem of LASD is the cost of the material, which is higher than asphalt melt sheets. However, the main advantage of this system is cost saving associated with robotically spray-applying, Fig. 8. With this robotically spray-applying technology, the product can be applied in various thicknesses, permitting optimization of the material geometry and location.

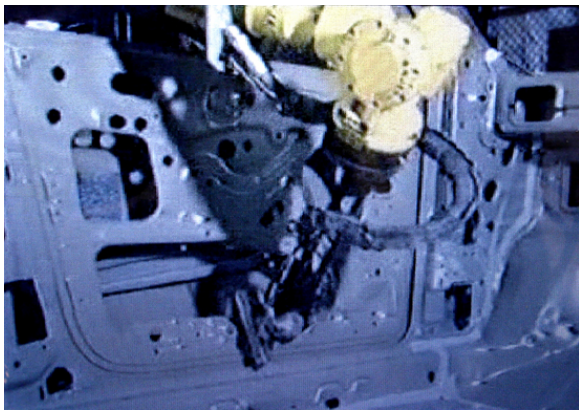

Figure 8: Robotically spray-applying.

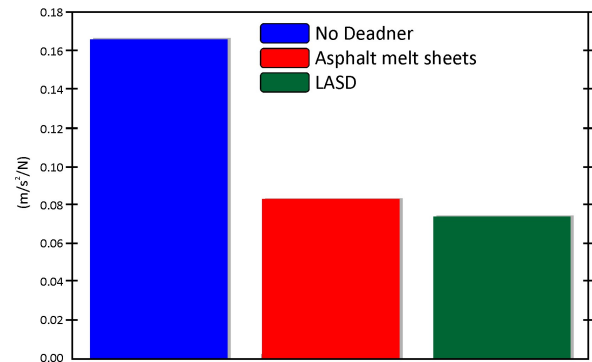

Figure 9: Comparison of vibration level of three different damping treatment. Blue: No deadeners; Red: Asphalt melt sheet; Green: LASD. (Furukava *et al.*, 2008)

It is important to mention others advantages of LASD material. It is water-base chemistry, which is easily acceptable for the automotive industry given them environmentally friendly and material handling flexibility (Bevan *et al.*, 2005). The system provides a reduction in part complexity, manual operation, handling, transportation and scrap, and an opportunity to consolidate interior and exterior applications by using the same material. High repeatability is another advantage. (Nakkash *et al.*, 2001).

Furukava *et al.*, (2008) made a comparison of damping treatment with asphalt melt sheet and LASD. An experimental optimization of material location in floorpan was done and the results are significant. For a body in white chassis with 2.24m² of asphalt melt sheet damping area, the experimental optimization reduced this area to 1.83m², which represents 19% of area reduction and a mass saving of 4.52kg. The optimized system has a reduction of vibration level better than asphalt melt sheet treatment (Fig. 9).

Thus it possible to conclude that this new water-based material applied by robot can have better results in passenger vehicle damping treatment than asphalt melt sheet. These results do not quantify a reduction of interior noise level. The current paper proposes to measure this reduction of noise using beamforming techniques.

3. BEAMFORMING

Beamforming is a technique for acoustic imaging that can estimate the source distribution of sound. Its principle is similar to a digital camera, however instead of acquiring light with a CCD chip, the sound field is sampled by a microphone array (Fig. 10b).

Consider an array of M microphones whose locations are given by $\{x_m\}, m = 1, 2, \dots, M$, with its center as the origin of coordinates. The classical delay-and-sum beamforming (Johnson *et al.*, 1993) is given by:

$$b(t) = \frac{1}{M} \sum_{m=1}^M w_m p_m(t - \Delta_m), \quad (1)$$

where w_m is a weighting, Δ_m is the time delay applied to the m th microphone and M is the total of microphones. Setting the time delays equal to the acoustic propagation times produces signal reinforcement as shown in Fig. 10a.

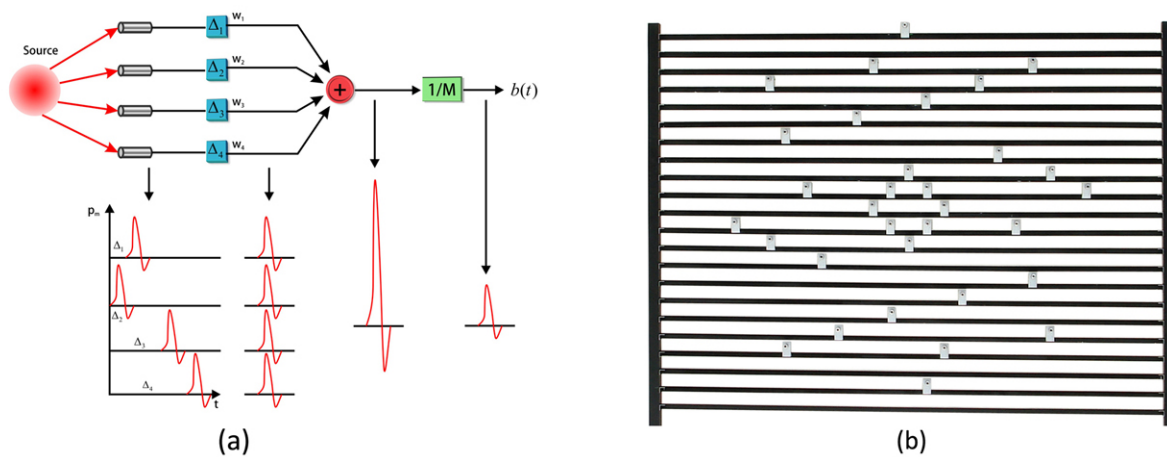

Figure 10: (a) Beamforming deconvolution algorithm; (b) Array of 32 microphones

There are improved algorithms that can suppress part of the limitations of this classical beamforming. In this work, almost of all the post-processing was performed with enhanced techniques, such as TIDY and DAMAS2, as discussed in Gerges *et al.*, 2009.

Further information about the acquisition system, array response and other principles of beamforming can be found in Fonseca, 2009.

3.1 DECONVOLUTION TECHNIQUES

The principle aim of beamforming is to form an image that represents the locations and strengths of the sound sources, usually as a color contour map. Ideally, a point source would give rise to a single spot in the image. Because of the finite aperture and discrete sampling of the microphone array, a point source is imaged as a peak with a certain width that depends on frequency and distance and pattern of smaller peaks called sidelobes (Underbrink and Dougherty, 1996). This pattern is known as the point spread function (PSF) of the array. If multiple acoustic sources are present, then the beamforming image will be the convolution of the source distribution with the PSF. Deconvolution is a technique that attempts to mathematically determine the source distribution by post-processing the beamform map. Examples of deconvolution algorithms are CLEAN (Hogboom, 1974), DAMAS (Brooks and Humphreys, 2004), and DAMAS2 (Dougherty, 2005).

CLEAN

CLEAN produces the “clean” version of the beamform map by locating the highest point in the original, “dirty” map and transferring this source location and strength to the clean map. The PSF for the identified source is subtracted from the dirty map, and the highest point in the updated dirty map is found. The process is iterated until the dirty map is empty and all of the sources have been found. CLEAN works best for discrete, incoherent, sources, and was originally developed for imaging stars in radio astronomy.

DAMAS and DAMAS2

DAMAS considers the relationship between the dirty map, the true source distribution, and the PSF as a very large linear algebra problem. The problem is solved for the unknown, the true source distribution, using an iterative technique. DAMAS can be very effective, but the computation is time consuming. DAMAS2 is a modified version of DAMAS in which the PSF is assumed to be shift-invariant. That is, a translation of the source is assumed to produce a translation of the PSF with no change in shape. The assumption of a shift-invariant PSF makes it possible to perform the iterations of DAMAS using FFT techniques. This reduces the computation time by several orders of magnitude. In practice, the PSF is only shift-invariant over a small angular sector. The version of DAMAS2 used for this work includes a coordinate transformation that expands the beamforming grid for large polar angles, making the shift-invariant assumption hold over almost a complete hemisphere.

CLEAN-SC and TIDY

CLEAN, DAMAS, and DAMAS2 assume that the various acoustic sources are mutually uncorrelated. This is not a reasonable assumption in some cases, such as noise created by a large vibrating panel. CLEAN-SC (Sijtsma, 2007) is similar to CLEAN, but is formulated to work with multiple coherent sources. In addition to extending the theoretical range of applicability of deconvolution techniques, CLEAN-SC has an additional advantage of being more robust to errors in the computed PSF caused by imperfections in the microphones and the array structure as well as other perturbing effects. CLEAN-SC, like the other methods discussed, is narrowband. It depends on a PSF that only applies to a narrow range of frequencies. Application over a wide band requires multiple, independent, calculations. TIDY is a generalization of CLEAN-SC to the time domain, giving a wide band algorithm. Whereas CLEAN-SC updates the array cross spectral matrix during the iteration process, TIDY updates the array cross correlation matrix. Each update accounts for a source and all of the energy that is temporally coherent with it. Experience has shown that TIDY works best for broadband sources when the processing bandwidth is chosen to be wide. The intuitive explanation is that TIDY takes advantage of the structure of the source across the whole range of frequencies. The implementation of TIDY used here operates with the same nonuniform grid as DAMAS2, which provides an optimal distribution grid points vs. array resolution. The wide grid reduces the likelihood that sidelobes from sources outside the beamform map will be confused with real sources on the map. The computation is performed over the wide grid and then a smaller area of the grid is output for the final result.

4. RESULTS

The car prototype used in the measurements is shown in the Fig. 11.

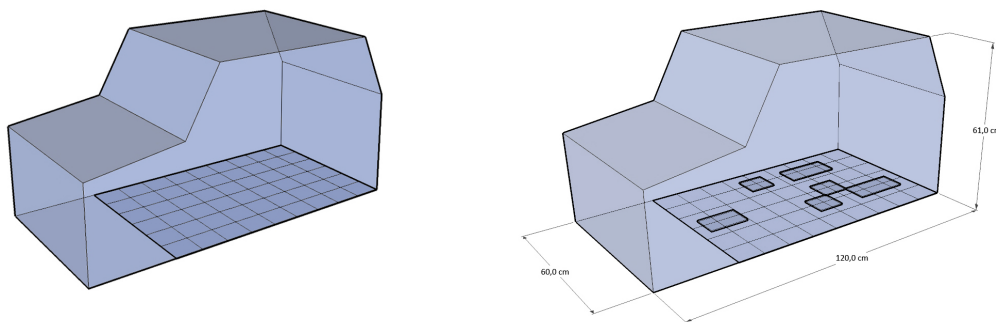

Figure 11: Car prototype used in the measurements.

4.1 RESULTS OF DAMPING TREATMENT

Vibration measurements for the ideal chassis prototype are illustrated in Fig. 12. Looking at the map, it is possible identify the region for the application of damping material for each 1/3 octave band of frequency up to 3200 Hz.

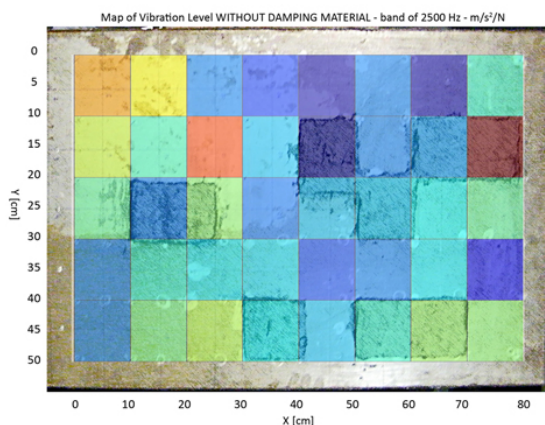

Figure 12: Map of vibration level on structure **without** damping treatment.

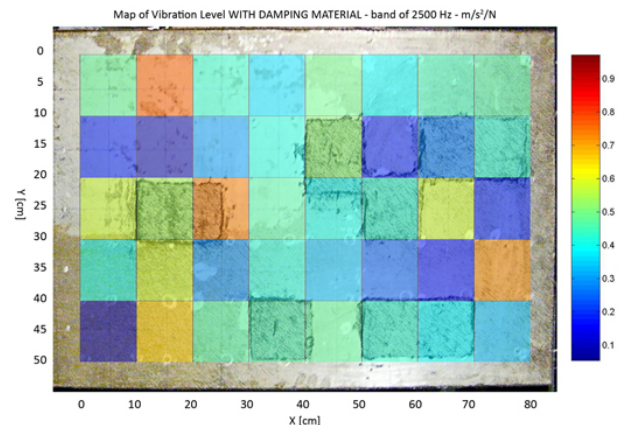

Figure 13: Map of vibration level on structure **with** damping material.

Damping material was applied to the identified regions Fig. 14, and a new series of measurements was done to confirm the reduction of vibration level, Fig. 13.

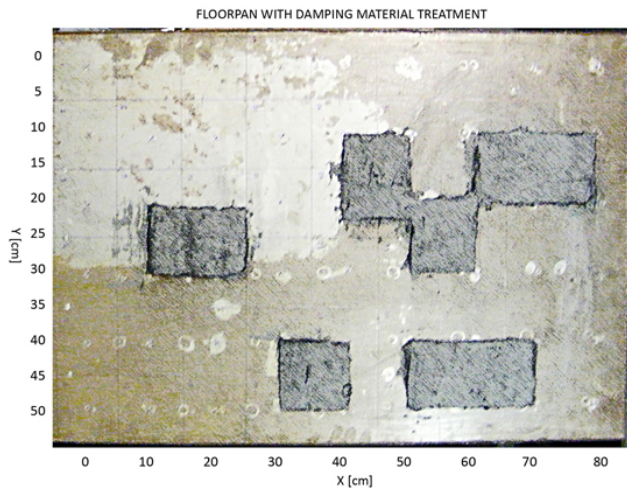

Figure 14: Damping material applied on structure.

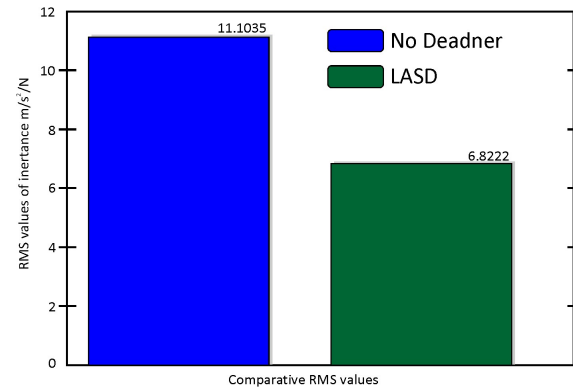

Figure 15: Comparison of RMS values of vibration levels in floor pan without damping and with LASD.

Comparing Fig. 12 with Fig. 13 the reduction of vibration level is notable and damping material application changed the regions where vibration levels were critical. The regions of application were defined considering not only this picture, but an intersection of all pictures obtained between 200 Hz and 3200 Hz.

This change of critical vibration region created by material application may change critical sound radiation region of floorpan in the prototype. It is important evaluate the effect of material damping application on sound radiation, because the added mass and stiffness may produced regions of non cancelation were the sound radiation is maximum.

The result of damping treatment on the prototype (Fig. 15) was similar to that found in Furukava et al. (2008). The methodology for defining the material application positions appears to have been successful because a reduction of 39% of global vibration level was obtained.

4.2 BEAMFORMING RESULTS

The beamforming and vibration measurements were performed simultaneously. They were performed in the semi-anechoic chamber at the Noise and Vibration Institute of UFSC. The array was positioned 2.1m from the surface of the prototype, with its center aligned to the prototype center.

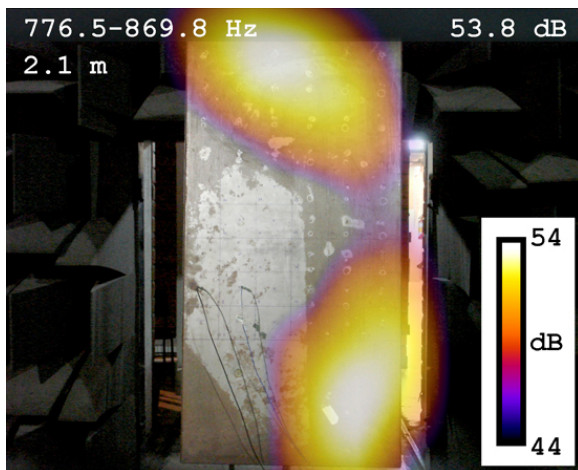

Figure 16: Beamforming results, TIDY post-processing, 776-869Hz, band 1/12, prototype without damping material.

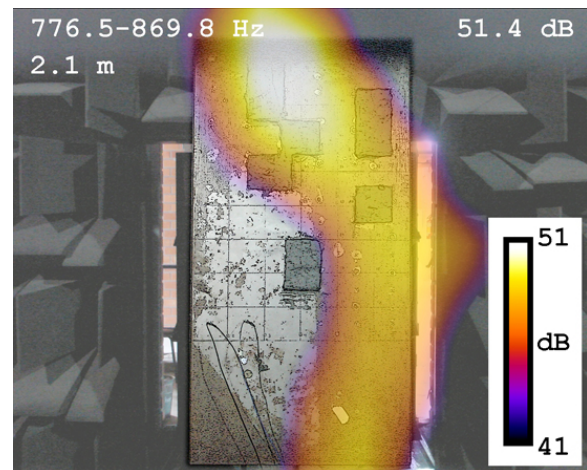

Figure 17: Beamforming results, TIDY post-processing, 776-869Hz, band 1/12, prototype with damping material.

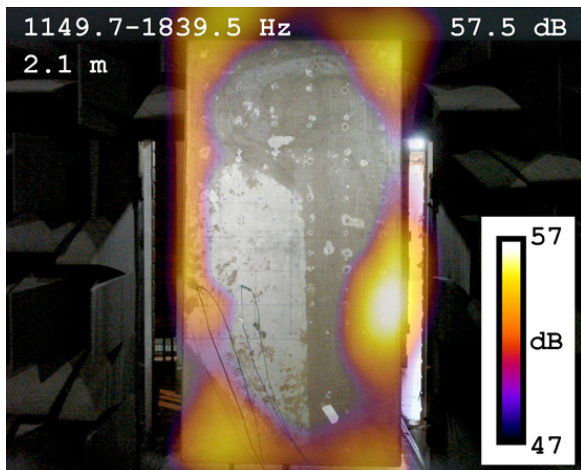

Figure 18: Beamforming results, TIDY post-processing, 1149-1839Hz, band 1/12, prototype without damping material.

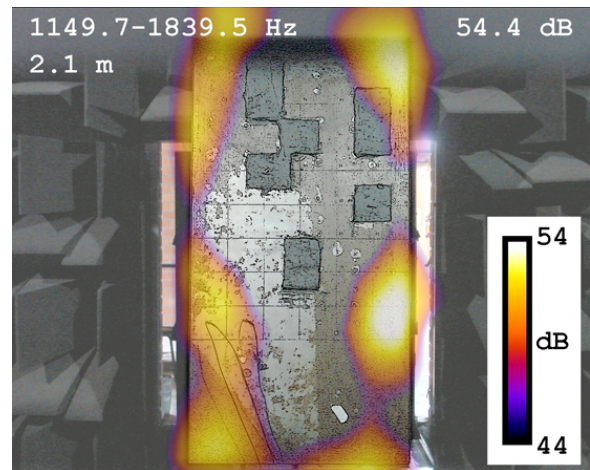

Figure 19: Beamforming results, TIDY post-processing, 1149-1839Hz, band 1/12, prototype with damping material.

The results obtained by beamforming follow the theory of vibrating plates described by Fahy, (2007). That is, the regions of uncancelled volume velocity radiate sound. In regular finite plates the sound emission is usually by the edges and the corners, as can be seen in the Figures 16-23.

These range of frequencies were selected because they are the regions of prominent noise. As can be observed in the Figures the SPL was reduced from 1.5dB to 3dB depending on the frequency. The damping material changed the distributions of volume velocity, therefore the sound source distribution of the prototype also changed.

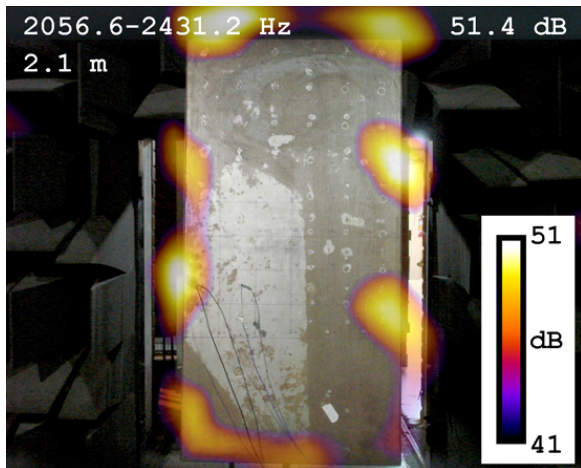

Figure 20: Beamforming results, TIDY post-processing, 2056-2431Hz, band 1/12, prototype without damping material.

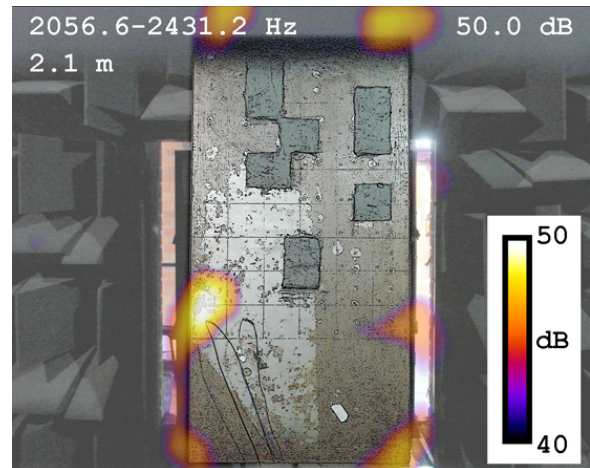

Figure 21: Beamforming results, TIDY post-processing, 2056-2431Hz, band 1/12, prototype with damping material.

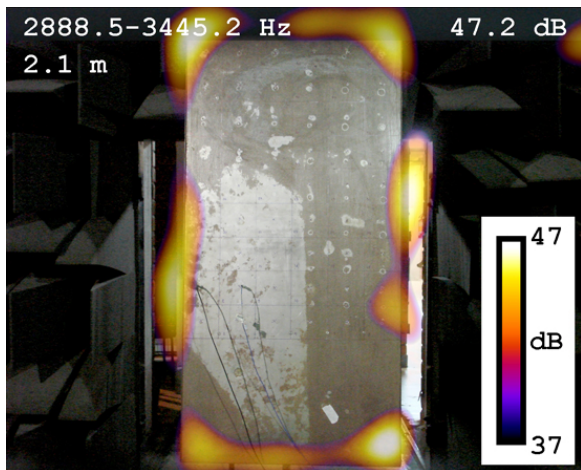

Figure 22: Beamforming results, DAMAS2 post-processing, 2888-3445Hz, band 1/12, prototype without damping material.

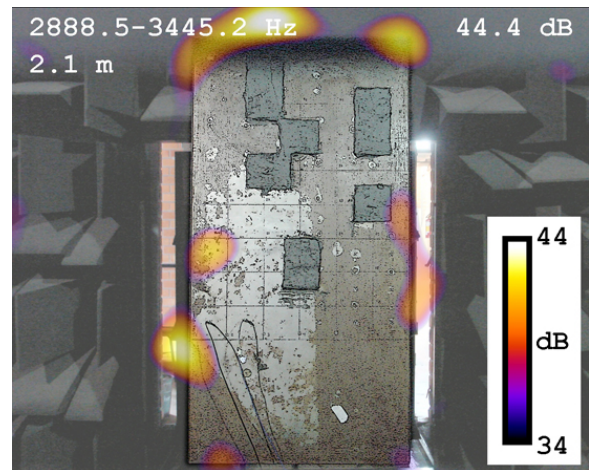

Figure 23: Beamforming results, DAMAS2 post-processing, 2888-3445Hz, band 1/12, prototype with damping material.

5. CONCLUSIONS

The results obtained by the beamforming technique revealed good agreement with analytical formulation for vibrating plates, proving that it is a suitable technique for this kind of acoustic measurement.

The correct application of damping material can contribute to the reduction of the vibration, as expected. About 39% of reduction in global vibration level was obtained.

The application of the material also changed the vibrational behavior of the floorplan. The sound source distribution also changed with the damping treatment, as evidenced by the acoustic images.

6. ACKNOWLEDGMENT

To CNPQ and CAPES for the financial support of the scholarships.
OptiNav Inc. for the support with enhanced beamforming techniques.

7. REFERENCES

- Beranek, L.L., 1988, "Noise and Vibration Control", Ed. MacGraw-Hill, Inc., Washington, DC, USA, 672p.
- Brooks, T.F. and Humphreys, W.M., 2004, "A Deconvolution Approach for the Mapping of Acoustic Sources (DAMAS) Determined from Phased Microphone Arrays", *10th AIAA/CEAS Aeroacoustics Conference*, AIAA-2004-2954, Manchester, Great Britain.
- Dougherty, R.P., 2005, "Extensions of DAMAS and Benefits and Limitations of Deconvolution in Beamforming", *11th AIAA/CEAS Aeroacoustics Conference*, AIAA-2005-2961, Monterey, California, USA.
- Fahy, F. and Gardonio, P., 2007, "Sound and Structural Vibration, Second Edition: Radiation, Transmission and Response", Academic Press, 2nd edition, 656 p.
- Fonseca, W.D., 2009, "Development and Application of an Acoustic Imaging System using Beamforming Technique for Moving Sources (Original: Desenvolvimento e Aplicação de Sistema para Obtenção de Imagens Acústicas pelo Método do Beamforming para Fontes em Movimento)", Master Thesis, Federal University of Santa Catarina, Florianópolis, Brazil, Feb. 2009.
- Furukava, M.; Marques, M.; Gerges, S.N.Y. and Penachio, L. F., 2008, "Desempenho de Amortecimento Estrutural em Veículos de Passeio", Proceeding of XVI SIMEA 2008 Simpósio Internacional de Engenharia Automotiva, São Paulo, Brasil.
- Gerges, S.N.Y.; Fonseca, W.D. and Dougherty, R.P., 2009, "State of the Art Beamforming Software and Hardware for Applications", The Sixteenth International Congress on Sound and Vibration. Kraków, Poland.
- Högbom, J.A., 1974, "Aperture Synthesis with a Non-Regular Distribution of Interferometer Base-lines", *Astron. Astrophys. Suppl.*, 15, p. 417-426.
- Johnson, D.H. and Dudgeon, D.E., 1993, "Array Signal Processing: Concepts and Techniques", 1st Edition, Prentice-Hall, New Jersey, USA, 533 p.
- Lilley, K.M.; Fasse, M.J. and Weber, P.E., 2001, "A Comparison of NVH Treatments for Vehicle Floorpan Applications", Proceeding of SAE 2001 Noise & Vibration Conference & Exposition, 2001-01-1464, Grand Traverse, MI, USA.
- Nakkash, G.H.; Visintainer, A.P. and Saha, P., 2001, "Understanding Laboratory Versus In-Vehicle Performance of Sprayable and Sheet Applied Damping Materials", Proceeding of SAE 2001 Noise & Vibration Conference & Exposition, SAE-2001-01-1465, Grand Traverse, MI, USA.
- Nashif, A.D.; Jones, D.G. and Henderson, J.P., 1985, "Vibration Damping", Ed. John Wiley & Sons, Inc., Canada, 453p.
- Rao, M.D., 2003, "Recent applications of viscoelastic damping for noise control in automobiles and commercial airplanes", *Journal of Sound and Vibration*, Vol. 262, N^o 3, pp. 457-474.
- Sijtsma, P., 2007, "CLEAN Based on Spatial Source Coherence", *13th AIAA/CEAS Aeroacoustics Conference (28th AIAA Aeroacoustics Conference)*, AIAA-2007-3436, Rome, Italy.
- Underbrink, J.R. and Dougherty, R.P., 1996, "Array design for non-intrusive measurement of noise sources", Noise-Con 1996, Bellevue, WA, USA.

8. RESPONSIBILITY NOTICE

The authors are the only responsible for the printed material included in this paper.