

A STUDY OF THREE CONTROL APPROACHES FOR THE CYCLIST ROBOT PROBLEM

Yesid Enrique Castro Caicedo, yesid_castro@unb.br

Carlos Humberto Llanos Quintero, llanos@unb.br

University of Brasilia

Department of Mechanical Engineering, Automation and Control Group (GRACO)

University Campus Darcy Ribeiro, 04386, Zip code 70910-900, Brasilia D.F., Brazil

Walter de Britto Vidal Filho, wbritto@unb.br

Federal University of Pernambuco

Department of Mechanical Engineering

Acadêmico Hélio Ramos, Zip code 50740-530 Recife, PE, Brazil

Leandro dos Santos Coelho, leandro.coelho@pucpr.br

Pontifical Catholic University of Paraná, PUCPR

Industrial and Systems Engineering Graduate Program, LAS/PPGEPS

Imaculada Conceição, 1155, Zip code 80215-901, Curitiba, Paraná, Brazil

Abstract. *This paper presents the modeling and control system for a robot that rides a bicycle using the well-known Acrobot model. Either two approaches are possible for the robot: (a) a dedicated configuration where the robot is the bicycle itself, and (b) the robot having human characteristics. In the first one, the stability of the robot can be achieved by means of the movement of the handlebar of the bicycle, with limitation of speeds. Therefore, in low speeds the centrifugal force generated by the circular or elliptical movement as a response of the handlebar movement is not enough to keep the robot balanced. On the other hand, the second option allows the robot to be controlled for low speed, even for null speed. In this case, the modeling of the robot cyclist has similarity to the problem of the underactuated inverted double pendulum (Acrobot). In this work the implementation of the controller was achieved for the second option following two ways. The first one implementation was developed based on modern control theories, involving: (a) the states feedback controller issues based on the appropriated poles allocation, guarantying stability and (b) the designs of a LQR (Linear Quadratic Regulator) type controller that minimizes the criterion of quadratic cost. The design flow of both controllers are based on the linear dynamic equations of the system due to their implicit nonlinearities. The second one implementation was achieved by mean of some intelligent control methods, which merge the capacity of learning of the neural networks with the power of linguistic interpretation of the fuzzy inference systems (neurofuzzy system ANFIS – Adaptive Neuro Fuzzy Systems-). Finally, a comparison between the proposed techniques of control is done based on the performance specifications of the obtained system response, as well as the performance index, and the system response due to parameters variations. To test the performance of the implemented controllers, the state variables of the system were calculated and a numerical solution was applied in order to obtain the system simulation. The controllers design were developed in Matlab and a three-dimensional virtual environment was developed using the Virtual Reality Toolbox, which allow the designer to test all the controllers over an virtual graphic model of the cyclist robot*

Keywords: *Modern Control, Intelligent Control, Mobile Robot, Self Sustaining, Three-dimensional Virtual Environment.*

1. INTRODUCTION

Several researches has been focused in the bicycle dynamic in order to construct a model that represents in a more appropriated way the system, and to develop controllers that allow reaching a condition of self sustaining during displacement for the cyclist robot. Due to the fact that these simple traction vehicles have narrower bodies, they show bigger maneuverability and capacity of movement when compared with double traction vehicles.

With regard to the bicycle modeling problem, David Jones works identifying geometrical characteristics that were different from the conventional ones, in 1970. The failure of the design and posterior construction of the early bicycles led to careful considerations of steering geometry because of the unstable condition that these vehicles presented (Jones, 1970). In 1972, D. H. Weir's UCLA motorcycle PhD thesis makes bicycle dynamics history, being the first researcher to explicitly compare his equations, in detail, with previous research (TUDELFF, 2009). In 1987, Jim Papadopoulos presents various results related to the dynamics of bicycles, obtaining a compact derivation of linearized equations (Papadopoulos, 1987). In 1988, B. C. Mears and R. E. Klein's PhD, confirmed the correctness of the Papadopoulos and Hand equations. In 2005, Åström, Klein and Lenarston wrote a paper which study bicycles from the perspective of control, models of different complexity that are developed starting with simple ones models and ending with more realistic ones generated from multibody software (Zhihua *et al.*, 2008). Additionally, he describes design of adapted bicycles for children with disabilities and clinical experiences of their uses (Åström *et al.*, 2005; Meijaard *et al.*, 2007; TUDELFF, 2009).

The parameters that describe the geometry of a bicycle are defined in Fig. 1. The key parameters are: wheelbase b , head angle λ and trail c . The front fork is angled and shaped so that the contact point of the front wheel with the road is behind the extension of the steer axis. Trail is defined as the horizontal distance c between the contact point and the steer axis, when the bicycle is in the upright reference configuration with zero steer angle. The riding properties of the bicycle are strongly affected by the trail. For instance, a large trail improves the stability but decreases the steering agility. (Åström *et al.*, 2005).

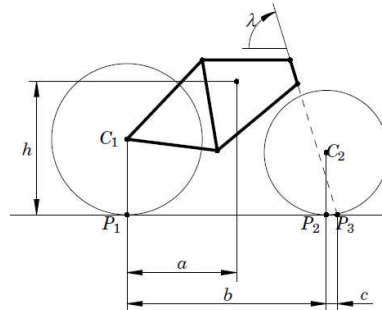

Figure 1. Parameters of geometric configuration for bicycle (Åström *et al.*, 2005)

We assume that the bicycle consists of three rigid parts: (a) two wheels, (b) a frame and (c) front fork with handlebars. This simplification is intuitively justified as a bicycle's behavior, which remains essentially the same when the bike and rider are coasting without pedaling. In the case where a rider is included in the analysis, the rider's upper body is modeled as a point mass that can move laterally with respect to the bike frame (Fig. 2.b). The bicycle can be considered as a mass point with two contact points with the ground (Fig. 2.a). The dynamic is widely studied in Jingang *et al.* (2006), Åström *et al.* (2005), Fajans (2000) and Yasuhito and Toshiyuki (2004). In this case, the effects of changing the geometrics parameters are considered as well as the holonomic considerations.

With regards to the controller design Åström *et al.* (2005) demonstrated that the stability control of the bicycle by means of steering controller for speeds less than a critic value is not possible. Under these considerations, as much the rider's upper body is considered as two mass points on space, a model of a robot cyclist (representing an inverted double pendulum under actuated – Acrobot – Fig. 2.c) can be proposed.

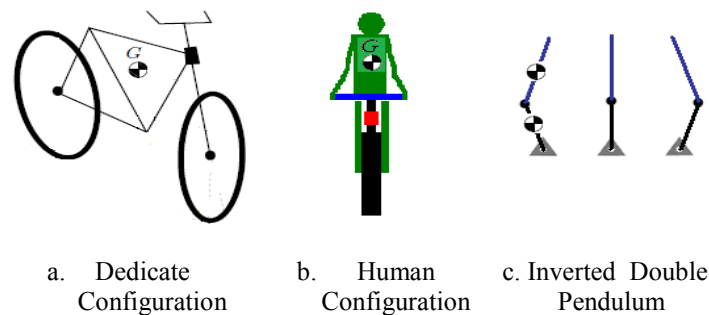

Figure 2. Model Approximation of Robot Cyclist.

In this of robot cyclist model, the bicycle and rider's lower part body are represented as the link with total mass M_1 , length L_1 , moment of inertia I_1 , whereas the rider's upper part body is represented whit the second link of mass M_2 , length L_2 , moment for inertia I_2 , the hip is represented like an actuator fixed into the first link. This system is known in the literature as Acrobot.

In 1990, Takashima studied fundamental problems for controlling a gymnast robot to perform some stunts on a high bar, in which two methods were proposed for increasing the swing amplitude. One of them is to pull up and pull down the mass center of the whole body. Another one is to oscillate swing by sinusoidal joint movement in eigenfrequency of the regarded pendulum (Takashima, 1990). In 1995, Spong proposes a strategy for the swing up control design based on defining an appropriate set of gains for the outer loop control that swings the second link close to its saddle point equilibrium and then to switch from the above partial feedback linearization controller to a Linear Quadratic Regulator (LQR) designed to balance the Acrobot about this equilibrium, whenever the trajectory enters the basin of attraction defined by the LQR controller (Spong, 1995).

In 1997, Brown and Passino developed an intelligent controller for swing up and balancing of the Acrobot. They developed classical, fuzzy and adaptative controllers to balance the acrobat in its inverted unstable equilibrium region, next a proportional-derivate (PD) controller with inner-loop partial feedback linearization, a state-feedback.

Additionally, a fuzzy controller was developed to swing up the Acrobot from its subtle equilibrium position to the inverted region, where they used a balancing controller to catch and balance it. At the same time, they developed two genetic algorithms for tuning the balancing and swing up controllers, and show how these can be used to help to optimize the performance of the controllers (Brown and Passino, 1997). Otherwise, Boone describes a direct search algorithm for finding swing up trajectories for the Acrobot. The algorithm uses a look ahead search that maximizes the Acrobot's total energy in an N-step window. Because the controls are extremal and the number of switches in the window limited, the algorithm is fast (Boone, 1997).

Kobori *et al.* (2002) proposed a child actor/critic into the actor part of parent actor/critic algorithm. They examined the proposed algorithm for a stable control problem in both simulation and prototype model of a joint-driven double inverted pendulum (Kobori *et al.*, 2002). In 2004, Kamio *et al.* proposed a new adaptive state space segmentation method based on fuzzy-ART neural network and overall reinforcement learning has been applied to a variety of physical control tasks. They include many purposive tasks with continuous state variables and discrete-valued actions (Kamio *et al.*, 2004). In 2008, Lukasz presents the results of a computer simulation, which combined a small network of spiking neurons with linear quadratic regulator (LQR) control to solve the Acrobot swing-up and balance task (Lukasz *et al.*, 2008).

Most of the earlier proposes have considered the Acrobot as a two-link arm that is unactuated at the first joint. In our work we consider the cycle robot stability problem as an Acrobot stability problem, which is actuated in the second link as Brown and Passino and Spong propose for the Acrobot. The last consideration allows us to study the cycle robot by using the Acrobot model and its well-known properties.

With regard to the controller design problem, in this paper apart from the classical LQR approach two different control techniques has been proposed: (a) states feedback and (b) ANFIS (Adaptative Neuro Fuzzy Systems) differently that the control techniques proposed by Spong (1995), Brown and Passino (1997), Takashima (1990), Kobori *et al.* (2002), Lukasz *et al.* (2008), Kamio *et al.* (2004) and Boone (1997).

The rest of this paper is organized as follows. We begin with the mathematical model for the cyclist robot dynamics in the section 2. In section 3 some theoretical fundamentals of control state feedback, LQR (Linear Quadratic Regulator) and ANFIS are introduced, and the three-dimensional representation for cyclist robot. The analyses of the controls response, numerical simulation of the inverted double pendulum and details of the interface between the Acrobot and the robot cyclist for the virtual representation are shown in the section 4. Finally, a conclusion of results closes this work.

2. MATHEMATICAL MODEL

In this work the mathematical model of the Acrobot was achieved by means of applying Lagrange method (Hung and Esfandiari *et al.*, 1997), see Eq. (1). In order to yield the solutions of equations the 4th order Runge Kutta method was chosen due to fact that the same produce more accurate results if compared with the Euler method (Boyce and DiPrima, 2001). In the modeling step an absolute coordinates system was proposed, achieving a simple equation system. The respective equations were linearized around of equilibrium point, producing the required matrices for the controllers design. The absolute coordinate system application approach is very interesting for the Acrobot system due to the fact its linearized system is more suitable to be represented in the state variable space. For example, both the Spong, and Brown and Passino modeling approach use an absolute coordinate system for the first link and a relative coordinate system for the second one. In this case, the obtained system after the linearization step is not suitable to be represented in the state variable space, given that most of terms of the matrices are canceled.

$$\begin{bmatrix} \left(\frac{m_1}{3} + m_2\right)L_1^2 & \frac{m_2}{2}L_1L_2\cos(\varphi - \alpha) \\ \frac{m_2}{2}L_1L_2\cos(\varphi - \alpha) & \frac{m_2}{3}L_2^2 \end{bmatrix} \begin{bmatrix} \ddot{\alpha} \\ \ddot{\varphi} \end{bmatrix} + \begin{bmatrix} 0 & -\frac{m_2}{2}L_1L_2\sin(\varphi - \alpha)\dot{\varphi} \\ \frac{m_2}{2}L_1L_2\sin(\varphi - \alpha)\dot{\alpha} & 0 \end{bmatrix} \begin{bmatrix} \dot{\alpha} \\ \dot{\varphi} \end{bmatrix} + \begin{bmatrix} \left(\frac{m_1}{2} + m_2\right)gL_1\sin(\alpha) \\ \frac{m_2}{2}gL_2\sin(\varphi) \end{bmatrix} = \begin{bmatrix} 0 \\ \tau \end{bmatrix}; \quad (1)$$

The equation (2) represents a multivariable system with four inputs variables in the state space (Ogata, 2003).

$$\begin{cases} x_1 = \alpha \\ x_2 = \dot{\alpha} \\ x_3 = \varphi \\ x_4 = \dot{\varphi} \end{cases}, \quad (2)$$

Now is possible to rewrite the system equations given in Eq. (1) as a 1st order differential equation system as shown in Eq. (3).

$$\begin{bmatrix} \dot{x}_1 \\ \dot{x}_2 \\ \dot{x}_3 \\ \dot{x}_4 \end{bmatrix} = \begin{bmatrix} 0 & 1 & 0 & 0 \\ \frac{-d_4 d_5}{d_5 d_1 - d_2^2} & 0 & \frac{d_2 d_6}{d_5 d_1 - d_2^2} & 0 \\ 0 & 0 & 0 & 1 \\ \frac{-d_4 d_2}{d_2^2 - d_5 d_1} & 0 & \frac{d_1 d_6}{d_2^2 - d_5 d_1} & 0 \end{bmatrix} \begin{bmatrix} x_1 \\ x_2 \\ x_3 \\ x_4 \end{bmatrix} + \begin{bmatrix} 0 \\ -d_2 \\ 0 \\ -d_1 \end{bmatrix} \tau; \quad (3)$$

where $d_1 = \left(\frac{m_1}{3} + m_2\right) L_1^2$, $d_2 = \frac{m_2}{2} L_1 L_2$, $d_4 = \left(\frac{m_1}{2} + m_2\right) g L_1$, $d_5 = \frac{m_2}{3} L_2^2$, $d_6 = m_2 g \frac{L_2}{2}$.

3. THEORETICAL FUNDAMENTS

3.1. Modern Control approach based on state variables

The state of the system is a set of variables such that the knowledge of these variables as well as the input functions and the dynamic equations produce the future state for the system (Hung and Esfandiari, 1997). For the development of the controllers was suppose that the system is controllable and time invariant as shown in Eq. (1), which was obtained around the equilibrium point $\{x_1, x_2, x_3, x_4\} = \{0, 0, 0, 0\}$. The states equation matrix is depicted in Eq. (4), where the matrices A and B are found from Eq. (3) and Eq. (4).

$$\begin{aligned} \dot{x} &= Ax + Bu \\ y &= Cx + D; \end{aligned} \quad (4)$$

where the matrixes C e D , are shown as following:

$$C = \begin{bmatrix} 1 & 0 & 0 & 0 \\ 0 & 0 & 1 & 0 \end{bmatrix}, \quad D = 0.$$

The control law is achieved in the Eq. (5), considering the reference being equal to zero, which indicates that the inverted double pendulum is in the vertical line.

$$u = -Kx. \quad (5)$$

The vector K represents the controller gains. Substituting Eq. (5) in Eq. (4), the closed-loop system is obtained in Eq. (6).

$$\dot{x} = (A - BK)x. \quad (6)$$

3.1.1. Linear Quadratic Regulator (LQR)

LQR theory uses a performance index in which is possible to optimize physical greatnesses. The goal of optimal control is defined by gain matrix K of the optimal control vector obtained in Eq. (5), in order to minimize the index of performance, as is shown in Eq. (7).

$$J = \int_0^{\infty} (x^T Q x + u^T R u) dt, \quad (7)$$

where Q and R are real Hermitian matrices, which are symmetrical positive defined. The relative importance of error and of the energy consumption is defined by the same matrices. If the elements of the matrix K were determinate in order to minimize the performance index Eq. (7), then the control law Eq. (5) is optimal for any initial state $x(0)$.

3.1.2. State feedback controller

In this work is considered the use of a controller with poles allocation by means of the state feedback in order to perform the regulation of desired outputs for the Acrobot system (both the position and angular speed). Moreover, the controller design is based on a linear system and the same is applied over the original nonlinear equations shown in Eq. (1). The feedback control system showed in Eq. (6) can be represented by means of the block diagram in Fig. 3.

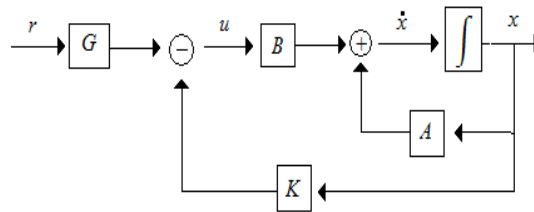

Figure 3. The block diagram of the state-feedback controller.

3.2. Intelligent control design

The project of intelligent control for both the linear and nonlinear systems has been widely used as an alternative to either those complex mathematical models or some ones which their mathematical model cannot be obtained. For developing a controller with predefined characteristics it can be considered a qualitative description of the system performance (based on linguistic variables) and a quantitative description (based on experimental data collections: data sets).

The neurofuzzy system ANFIS merges the human-like reasoning style of fuzzy systems with the learning and connectionist structure of neural networks. A wide variety of algorithms have been proposed to this problem (Fsom, Nefclass, Fuzzytech, etc.) and the seminal ideas were developed for Jang (1993). The traditional neurofuzzy ANFIS systems have a limited capacity of adjustment in its structure and due to the rule number explosion problem these model is generally used in the applications with restrict input number (Kelly *et al.*, 1994). Moreover, the major part of these neurofuzzy systems are only appropriate for supervised training.

3.3. Virtual Realm Builder 2.0 (V-Real Builder)

The Virtual Reality Toolbox (Ozana, 2008) allows the user to connect a virtual world scene with a Simulink or Matlab models. This toolbox is based on the language VRML (Virtual Reality Modeling Language).

VRML is a high performance language for three-dimensional (3-D) visualization on the World Wide Web (WWW), which is defined in a file format that describes virtual objects and worlds. Each VRML file implicitly establishes a coordinate system for all the defined objects. V-Realm Builder is a graphic editor of VRML files, which includes a computational package for three dimensional objects creation and virtual worlds to be showed in its proper virtual platform of the V-Realm or any other compiler for VRML (for instance, from Matlab). V-Realm Builder was projected to provide tools in order to minimize the file sizes and to supply tools for complex object models from primitive shapes, without overloading the net (V-Realm™ Builder, 2009).

4. ANALYZES AND RESULTS

The Linear Quadratic Regulator (LQR), the State Feedback (SF) and the Fuzzy controllers were all designed for stabilizing the cyclist robot for small or null speeds. The parameters used for numerical simulation and controllers test are $L_1=L_2=0.4$ Kg, $M_1=M_2=1$ Kg, $g=9.8$ m/s² and the inertia moments are considered in the middle of links as $I_1=I_2=(1/12)M_{1,2} \times L_{1,2}^2$.

For the design of the LQR controller is necessary to define both the Q and R matrices, which were experimentally chosen observing to system response. The R matrix represents the energy consumption of the control signals and is related to a reduction/enlargement of the requirements of input torque in the cost criterion (Brown and Passino, 1997). On the other hand, the Q matrix is related both to the overshoot and stabilization time of the system. In this project different values were tried for the matrices and the better response was found using the values: $R=7000$ and $Q = [1000 \ 0 \ 0 \ 0; \ 0 \ 0 \ 0 \ 0; \ 0 \ 0 \ 1000; \ 0 \ 0 \ 0 \ 0]$.

The results are depicted in Fig. 4. The Fig. 4.a shows the LQR controller response with initial conditions $\{x_1, x_2, x_3, x_4\} = \{15, 0, -15, 0\}$, where the stabilization time of system is less than three seconds. Additionally, the required torque variations are shown. Otherwise, it can be observed that the torque does not overtake the 1.5 Nm value for these conditions. Fig. 4.b. shows the system response when applied an 1.5 Nm disturbance in a impulse form of 0.05 sec. Additionally, in the same figure is shown how the system is again stabilized in less than one second. The disturbance is applied in the 5 second time and it is also shown the torque variations. The Fig. 4 depicts the satisfactory performance of the system.

For the state feedback method is assumed that all state variables are measurable and available for feedback. If the system is completely state controllable, then the closed-loop poles of the system can be placed in any one desired position by means of the state feedback, using appropriate matrix gains. To find the matrix gains that leads the system for the desired positions the root locus technique is used in order to observe dominants poles of the system. Four states variables were used for the system representation and the gains vector is conformed with four elements corresponding with the gain for each state variable. The idea is to choose a pair of dominant poles for the system and the others ones

are placed to the left of these. The allocation of the pole positions can be chosen for different values, but any positions have the best behavior. The chosen poles are $\{-0.2 \pm 11.5274i, -2, -8\}$ and different methods can be used to find the matrix gain (namely, Ackerman, Bass-Gura, Mayne-Murdoch), using the A and B matrices. The Ackerman method was chosen and the respective feedback gains were obtained using a Matlab function (satisfying the block diagram shown in Fig. 3).

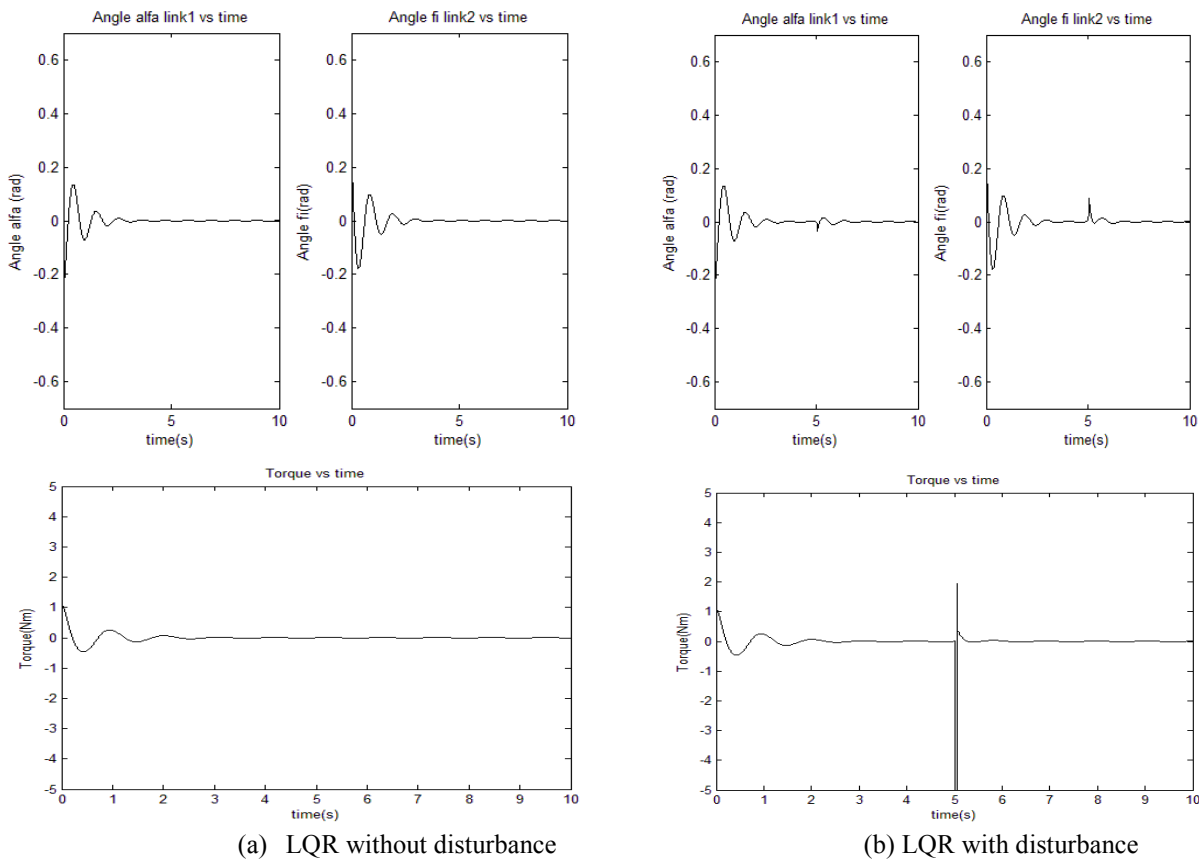

Figure 4. System controlled by LQR.

The Fig. 5 shows the system response using the control law showed in Eq. (5) and the matrix gains $K = \{67.2601, -61.8928, -34.0390, -23.6652\}$. The initial conditions used are: $\{x_1, x_2, x_3, x_4\} = \{15, 0, -15, 0\}$. Fig. 5.a. shows the stabilization behavior. In this case the time is less than 2.5 sec. without an overshoot, differently than the LQR controller for the same initial conditions (see Fig. 4).

The Fig. 5.b. shows the system response when applied a 1.5 Nm disturbance in form of 0.05 sec. impulse. The system goes quickly for the invert position and this in turn leads the pendulum for the inverted position again, preventing the system from knocks down. It can be observed that the control effort of state feedback approach is larger than the LQR controller. In contrast, the state feedback system converges more quickly.

The ANFIS system merges both the capacity of learning of the neural networks with the capacity of linguistic interpretation of the inference diffuse systems, and permits the uses of learning algorithms (developed for neural networks). The data set used for membership functions training of neural-fuzzy systems is achieved from the developed state feedback controller, due to absence of the real system. The intelligent control learns the behavior of the system under action of state feedback controller. The architecture of the ANFIS system for the fuzzy system learning process was generated by a Matlab toolbox. Three membership functions have been chosen for each input of the neurofuzzy system. All the member functions are Gaussian type functions and the fuzzy controller is a Takagi-Sugeno type (Coelho *et al.* 2003). The system ANFIS generated 81 singletons outputs and the network was trained by an hybrid algorithm (the backpropagation plus squared minimums methods). In the training process a set of 8000 data and 100 epochs were spent.

The Fig. 6 shows the system behavior with the fuzzy controller optimized by ANFIS with initial conditions, namely: $\{x_1, x_2, x_3, x_4\} = \{-15, 0, 15, 0\}$. Figure 6.a. shows the system response without disturbance and the Fig. 6.b. shows the system response with the same disturbance used for the others controllers. The system learned from the state feedback controller, but the system response with intelligent control is a little bit different. Note that the results are very

similar in Fig. 5 and Fig. 6. Otherwise, Fig. 6.b. shows that the intelligent controller is more robust than state feedback one and additionally the same stabilizes the system faster than the state feedback one.

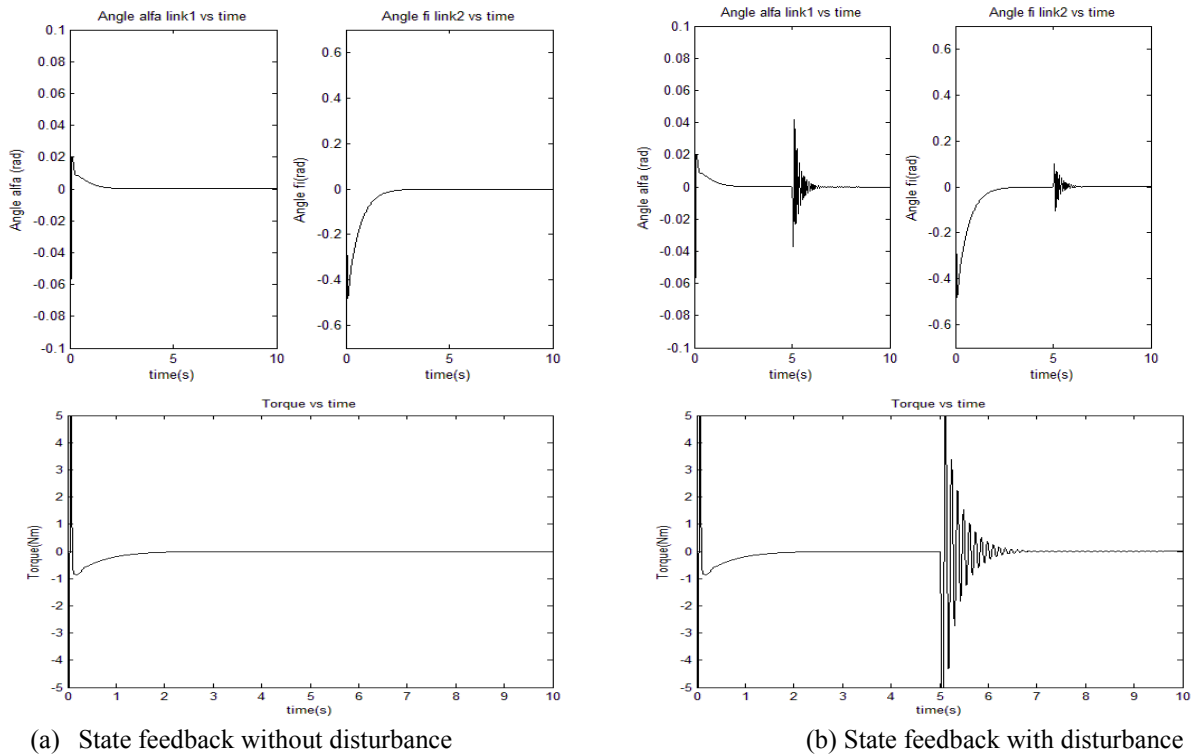

Figure 5. System controlled by state feedback.

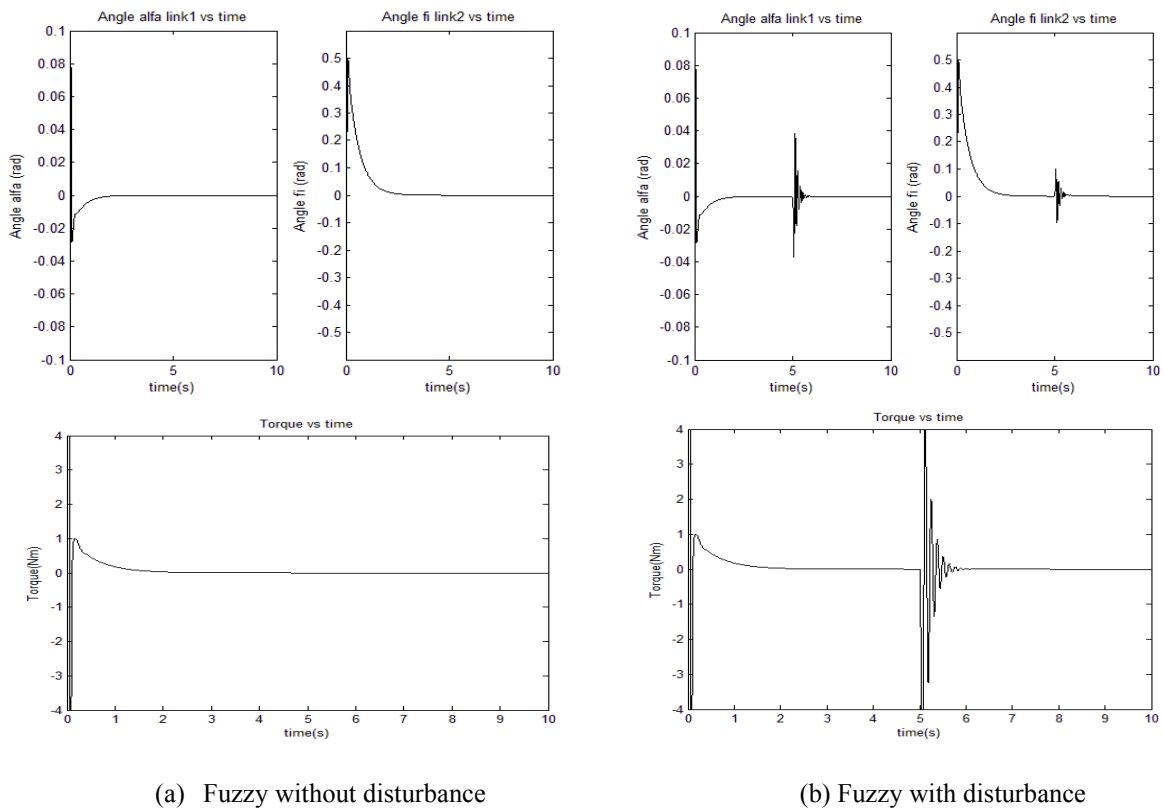

Figure 6. System with fuzzy controller optimized by ANFIS.

Table 1. Performance index of the controllers

| Controllers | J_1 | | J_2 | J_1 | | J_2 |
|--------------|---------------------|-----------|--------|------------------|-----------|--------|
| | Without Disturbance | | | With Disturbance | | |
| | α | φ | u | α | φ | u |
| LQR | 0.7055E-3 | 0.7925E-3 | 0.0012 | 0.7133E-3 | 0.8207E-3 | 0.5007 |
| S-F | 0.0001 | 0.0041 | 0.0745 | 0.0001 | 0.0042 | 0.0906 |
| ANFIS | 0.0002 | 0.0069 | 0.0866 | 0.0002 | 0.0070 | 0.1129 |

Two performance indexes (Copetti *et al.*, 2007) have been applied for the developed controllers in order to have quantitative points for comparison in terms of the variations of the control signals and the behavior of the error throughout the simulation run time. This can indicate how the controller is fast for reaching the vertical position and how much effort is made by the actuator. The performance indexes are the sum of squared error and the sum of the quadratic control increment, as shown in the Eq. (8) and Eq. (9), respectively.

$$J_1 = \frac{1}{N} \sum_{k=1}^N [e(k)]^2 \tag{8}$$

$$J_2 = \frac{1}{N} \sum_{k=1}^N [u(k) - u(k - 1)]^2. \tag{9}$$

In the Tab. 1 is shown the achieved values for the performance indexes in the simulation time. The error values of the angles links with the J_1 index (with and without disturbance for each controller) are shown as well as the signal variations of the controllers in relation to the J_2 index. In the case of the test without disturbance, the LQR controller presents a higher value of J_1 for the two angles case against the state feedback and ANFIS controllers. This means that the two links have a larger movement around the vertical axis, generating higher error values. This can be observed comparing the Fig. 4.a., Fig. 5.a. and Fig. 6.a. Otherwise, comparing the LQR against the state feedback controllers it can be observed that the state feedback controller has J_1 index with lower values. This means that the system is stabilized a little faster than the LQR controller. The J_2 index indicates that the LQR controller demands less actuator effort than the state feedback and ANFIS ones. When the systems is submitted to a disturbance, the state feedback and ANFIS controllers continues showing less values for J_1 index whether compared with the LQR controller. The values J_1 almost not have been modified, which means that they are more robust than the LQR one (in relation to the disturbance) and the J_2 index indicates that the LQR controller requires a larger actuator effort.

Finally, a three dimensional prototype was developed for the robot cyclist using the programming language Virtual Realm Builder 2.0 in a such a way to supplies a graphic interface to the user. Additionally, an object in Matlab was created to have access to prototype instances from the main program. Figure 7.a. shows the project of the cyclist robot shape for different point of views. On the other hand, each part of robot cyclist is an object that has relative coordinates with relation to its proper geometric center and absolute coordinates of the virtual space. This coordinate system is different from Matlab coordinates, for which the programmer must define their appropriated values. In general 13 objects had been used for the upper's rider and the lower's rider, whereas the bicycle spent 45 objects.

The prototype achieved in Virtual Realm 2.0 Builder and Matlab implements the Acrobat behavior, assuming that the front part of bicycle is in the same plan that the bicycle frame. The lean of the bicycle with relation to the vertical line is in agreement with the lean of the first link. Additionally, the trunk of the rider is in agreement with the lean of the second link (Fig. 7.b. and Fig. 7.c.). This is possible through the actuator action that substitutes the hip of the rider. The state variable is delivered for the virtual prototype at each time. Notice that the direction of the angles is inverted due to the fact that there is a different coordinate system between the Matlab and the Virtual Realm Builder simulator.

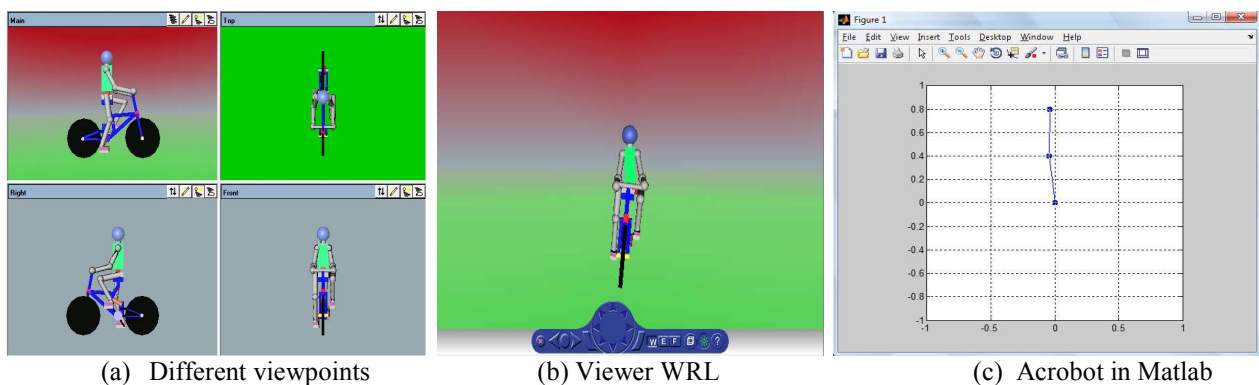

Figure 7. Three dimensional representation of robot cyclist using Virtual Realm Builder 2.0.

5. CONCLUSION

This work showed the implementation of the cyclist robot control system using three implementation techniques namely: LQR, state feedback and intelligent control. Under some restrictions was possible to obtain cyclist robot model from the underactuated double pendulum (Acrobot). Additionally, it was shown that the development of linear controllers applied to the case of the stabilization of the robot is sufficiently robust and offers results as good as the controllers based on artificial intelligence. The state feedback controller presents a more systematic generation of its parameters in relation to the process for finding the gain values. For the LQR case, a more empirical process needs to be executed throughout the matrices Q and R . In the same way, the fuzzy controller, optimized by ANFIS tool, requires a supervisor for the learning step. The performance index for all developed controller have shown several characteristics that depend on their physics parameters of the system (for instance: actuators, body mass, the prototype size, etc.), which has an important factor in several choices related to the construction of a real prototype. In contrast there exist a trade-off among energy consumption, stability and the speed response (as shown section 4). The potential of the use of systems based on the project of three-dimensional virtual systems was evaluated, and our results show that these systems permit a real approach with the project requirements. The three-dimensional systems permit to yield an experimental base that can be used for a real system design. Considering the dynamic movement equations of the bicycle presented in the literature and the model proposed in this paper it is possible to find a stability condition for the cyclist robot in any state.

Our results show that is possible to obtain a better control of the cyclist robot by switching the actions of several controllers, depending on the critical speed. For instance, the control task can be improved by switching both the steering and the trunk rider controller.

6. REFERENCES

- Åström, K. J., Klein, R. E. and Lennartsson, A., 2005, "Bicycle Dynamics and Control: Adapted Bicycles for Education and Research", *Proceedings of the IEEE Control Systems Magazine*, Vol. 25, Issue 4, pp. 26-47.
- Boone, G., 1997, "Minimum-time Control of the Acrobot", *Proceedings of the International Conference on Robotics and Automation IEEE*, Vol. 4, Albuquerque, New Mexico USA, pp. 3281 – 3286.
- Boyce, W., Diprima, R., 2001, "Equações Diferenciais Elementares e Problemas de Valores de Contorno", pp. 225-244. Sétima edição, LTC Editora, Rio de Janeiro, Brazil.
- Brown, S. C., Passino K. M., 1997, "Intelligent Control for an Acrobot", *Proceedings of Journal of Intelligent and Robotic Systems*, Vol. 18, Issue 3, Netherlands, pp 209 – 248.
- Chen, C.T., 1999, "Linear System Theory and Design", *The Oxford Series in Electrical and Computer Engineering*, Oxford, New York, USA, 3rd edition.
- Coelho, L. S., O. M. Almeida e Coelho A. A. R., 2003, "Projeto e Estudo de Caso da Implementação de um Sistema de Controle Nebuloso", *Revista SBA Controle & Automação*, Vol. 14, Issue 1, pp. 20-29.
- Copetti, C. T., Coelho L. S. e Coelho A. A. R., 2007, "Controle Nebuloso Adaptativo por Modelo de Referência: Projeto e Aplicação em Sistemas Não Lineares", *Revista Controle & Automação*, Vol. 18, No. 4, Brasil, pp. 479-489.
- Fajans, J., 2000, "Steering in Bicycles and Motorcycles", *Proceedings American Journal of Physics*, Vol. 68, Issue 7, pp. 654 – 659.
- Hung, V. V., Efsandiari, R. S., 1997, "Dynamic Systems: Modeling and Analysis", pp. 108-155. McGraw-Hill, Singapore.
- Jang, J. S. R., 1993, "ANFIS: Adaptive-Network-Based Fuzzy Inference System", *Proceedings of IEEE Trans. on Sys., Man, and Cybernetics*, Vol. 23, No. 3, pp. 665-685.
- Jingang, Y. D. S., Levandowski A. and Jayasuriya S., 2006, "Trajectory Tracking and Balance Stabilization Control of Autonomous Motorcycles", *Proceedings of IEEE International Conference on Robotics and Automation*, Orlando Fl., pp. 2583-2589.
- Jones, D. E. H., 1970, "The Stability of the Bicycle", *Proceedings of Physics Today*, London, Vol. 23, Issue 3, pp. 34 – 40.
- Kamio, T.; Soga, S.; Fujisaka, H.; Mitsubori, K., 2004, "An Adaptive State Space Segmentation for Reinforcement Learning Using Fuzzy-ART Neural Network", *Proceedings of the 47th IEEE International Midwest Symposium on Circuits and Systems*, Hiroshima, Japan, Vol. 3, pp. iii-117-20.
- Klein, F. and Sommerfeld, A., 1910, "Über die Theorie des Kreisels", ch. IX, Section 8, pp. 863-884.
- Kobori, N., Kenji S., Pitoyo H. and Shuji H., 2002, "Learning to Control a Joint Driven Double Inverted Pendulum Using Nested Actor Critic Algorithm", *Proceedings of the 9th International Conference on Neural Information Processing (ICONIP'02)*, Singapore, Vol. 5, pp 2610 – 2614.
- Lukasz W., Stephan C., Rick M., 2008, "A Small Spiking Neural Network with LQR Control Applied to the Acrobot", *Proceedings of the Neural Comput & Applic*, Vol. 18, Issue 4, pp. 369-375.

- Meijaard J. P., Papadopoulos J.M., Ruina, A., Schwab A. L., 2007, "Linearized Dynamics Equations for the Balance and Steer of a Bicycle: a Benchmark and Review" Proceedings of the Royal Society A, Vol. 463, pp. 1955-1982.
- Ogata, K., 2003, "Engenharia de Controle Moderno", 4^a ed, Prentice Hall of Brazil.
- Ozana, S., 2008, "Visualization of Active Suspension by Robust Controller in Virtual Reality Toolbox", Proceedings of 19th IEEE International Conference on System Engineering, Las Vegas NV, Vol. 19, pp. 38-42.
- Papadopoulos, J. M., 1987, "Bicycle Steering Dynamics and Self-stability: A Summary Report on Work in Progress", Technical report, Cornell Bicycle Research Project, Cornell University New York, USA, pp. 1-23.
- Spong, M. W., 1995, "The Swing up Control Problem for the Acrobot", Proceedings of Control Systems Magazine, IEEE, Vol. 15, No. 1, pp 49 – 55.
- TUDELFT, 2009. "History of Bicycle Steer and Dynamics Equations", 27 January 2009, <<http://www.tudelft.nl/live/pagina.jsp?id=25d19ab8-47e8-4427-831c-4d0680fd2c2c&lang=en>>.
- Takashima, S., 1990, "Dynamic Modeling of a Gymnast on a High Bar", Proceedings IEEE International Workshop on Intelligent Robots and Systems (IROS'90), Ibaraki, Japan, Vol. 2, pp 955-962.
- V-RealmTM Builder, 2009, "User's Guide and Reference", 2 Feb. 2009, <http://metalab.uniten.edu.my/~farrukh/vrml/user_guide.pdf>.
- Yasuhito T., Toshiyuki M., 2004, "Self Sustaining Bicycle Robot with Steering Controller", Proceedings of the 8th IEEE International Workshop, Kawasaki, Japan, pp. 193-197.
- Zhihua L., Ling Z., Huili Z., 2008, "Solving PDE Models in Modelica", Symposium IEEE Information on Information Science and Engineering, Shanghai, China, Vol. 1, pp 53-57.

7. RESPONSIBILITY NOTICE

The authors are the only responsible for the printed material included in this paper.