

FAULT DETECTION IN A 3DOF HELICOPTER SYSTEM

Elen Collaço de Oliveira, elencollaco@gmail.com

Guilherme Monteiro Garcia, guifiles@gmail.com

Jackson Paul Matsuura, jackson@ita.br

Roberto Kawakami Harrop Galvão, kawakami@ita.br

Instituto Tecnológico de Aeronáutica - ITA, Department of Systems and Control
12.228-900 – São José dos Campos, SP, Brazil.

Abstract. *This paper presents a fault detection scheme based on k-means clustering. In the proposed approach, the k-means algorithm is applied in unsupervised learning of patterns from system input-output data acquired under normal operating conditions. This method does not require an accurate model of the system, additional equipment or historical records of faults on the system. The pattern classification technique will be used to determine regions that reflect adequately the normal operating signature. The normal behavior is verified by calculating the Euclidean distance from each set of measurements to the centroids of the learned clusters. The clusters represent regions in the n-dimensional space composed by system variables. These regions contains the variables joint trajectories during normal operating conditions and are used to verify if the relation among system variables remains the same. Otherwise, a fault is declared. Additionally, an analytical redundancy using a wavelet filter bank scheme for fault detection based on the monitoring of the innovations of a Kalman filter is used for comparison. For experimental validation of the proposed scheme, a pilot plant in the form of a three-degree-of-freedom helicopter is employed. The system has two DC (Direct Current) motors, each one coupled to a propeller. The actuation signals consist of voltages applied to the motors. Three types of movements are possible: elevation, pitch and travel. The fault under consideration consists of a 10% reduction in the gain of one of the motors during a landing procedure. The results in terms of detection delay and ROC (Receiver Operating Characteristic) curve indicate that the method has good potential when compared with analytical redundancy, with the advantage of not requiring an analytical model of the system and without necessarily being complex or costly to implement.*

Keywords: *Fault Detection, Pattern Classification, Clusterization.*

1. INTRODUCTION

Owing to the technological advancing and the need of complex systems operating in high performance, the fault detection becomes each time more important in automatic control systems. Over the past decades, the fault detection problem has received much attention and have been reported in Isermann *et al.* (2000), Zhong *et al.* (2007), Fekih (2007), Angeli and Chatzinikolau (2004), Patton *et al.* (2000) and Venkatasubramanian *et al.* (2003a); (2003b); (2003c)

If the faults can be detected, the level of safety will be better, for being detected what caused the fault, the correction will be done quicker, preventing an incorrect operation of the system even with errors. Thus, harmful damages to the environment, in the economic area and mainly to human beings, would be avoid (Matsuura, 2006; Paiva, 2003).

The trustworthy and security are essential characteristics to reach the excellent performance of an automatic control system (Polycarpou and Helmicki, 1995). However, is necessary the development of new methods to give an improvement to the dynamic systems making sure the quality and cut in the costs. In case it is not possible to continue a safe operation of the system, it is at least possible to give an alert about the danger to start a procedure to safe turning off of the system. Thus, to have in hands mechanism of fault detection is of major importance to applications that involve risk operations, such as chemical processes (Ulerich and Powers, 1988), nuclear reactors (Li and Bernard, 2002), vehicles of public transportation (Capriglione *et al.*, 2004) and airspace vehicles (Patton and Chen, 1992; Marcos *et al.*, 2005).

The first steps used in fault detection were based mainly on physical redundancy, in which multiple sensors are installed to measure the same physical quantity and any serious discrepancy between the measurements indicates a sensor fault. Although, this solution is difficult to get in physical space limits, and also make the cost of the project more expensive due to the increase of the number of measurement devices (Gertler, 1998).

The analytical redundancy, in which the measures of the sensors are compared with the signals coming from system models, as shown on Fig. 1. A fault alarm is launched when the difference (“residue”) from the measured signal to the estimated value of the signal goes over a certain bound. Such procedure allows the fault detection not only in sensors but also in the actuators and in the plant itself. But, the system modeling is critical, because differences between the model and the plant can produce residuals incorrectly detected as faults (Cordier *et al.*, 2004).

The conventional fault detection methods, however, present difficulties associated to physical space, inexistence of an accurate mathematical model of the system.

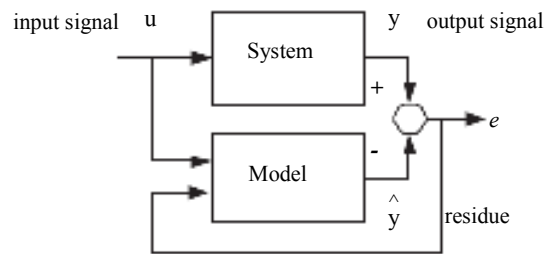

Figure 1: Scheme of analytical redundancy for fault detection.

The last decade witnessed a rapidly growing interest in pattern recognition approaches or classifiers in fault detection and diagnosis. These methods are constructed generally from historic process data. Considerable interest has been shown in the literature in the application of neural networks and Bayesian network for the problem of fault diagnosis and many important results have been reported in Cybenko (1988), Venkatasubramanian and Chan (1989), Ungar *et al.* (1990), Hoskins *et al.* (1991), Vaidyanathan and Venkatasubramanian (1992), Riascos *et al.* (2005), Chien *et al.* (2002), Patton *et al.* (1994).

Although, most methods are limited solely on history process knowledge of faults occurring in the system, information about failures is not always available, mainly in critical systems in which generally there is no history data of any operation with failure. However, to overcome disadvantages of this methods, an alternative is to use techniques based in unsupervised learning of patterns from system input-output data acquired under normal operating conditions.

The k-means clustering method has been shown to be effective for many practical systems. This classification method is quite simple and suitable for some applications. Especially in fault detection, Matsuura (2006) proposed an approach using the k-Means algorithm by learning from the historical without a fault information.

Following the results presented in Matsuura (2006), in this work a fault detection scheme using k-means clustering is employed. In the proposed approach, the k-means algorithm is applied in unsupervised learning of patterns from system input-output data acquired under normal operating conditions. Additionally, an analytical redundancy scheme for fault detection based on the monitoring of the innovations of a Kalman filter is used for comparison purposes. In the analytical redundancy approach, the state-space model employed in the filter is obtained by an identification procedure on the basis of input-output data acquired under normal operating conditions. For this purpose, a subspace method, which provides the Kalman filter gains as a by-product of the identification, is adopted. In addition, a wavelet filter bank is used to analyze the innovations at an appropriate scale level (Milhan, 2006).

2. SYSTEM DESCRIPTION

The experimental platform used in this work is the three-degree-of-freedom 3DOF helicopter presented in Fig. 2(a), which can perform elevation, pitch and travel motions. This laboratory system is inspired in tandem helicopters such as the Boeing CH-47 Chinook shown in Fig. 2(b). The actuators consist of two propellers driven by DC (Direct Current) motors mounted on the helicopter body.

The system consists of a base upon which an arm is mounted. The arm can rotate about an elevation axis (E) and can turn about a vertical axis (T) as shown in Fig. 3. Two encoders installed on these axes provide measurements of the elevation angle (4096 pulses per revolution) and travel angle (2048 pulses per revolution) of the arm. The helicopter body is free to swivel about a pitch axis (P), as depicted in Fig. 3. The pitch angle is measured via a third encoder (4096 pulses per revolution) (Quanser, 2005).

The arm carries the body of the helicopter formed by a frame, two motors and propellers installed at the end of the arm. The opposite side of the arm has a counterweight, which minimizes the motor effort to keep the set in air.

The system has three degrees of freedom (T, E, P) and two control inputs resulting in forces F_b and F_f , as illustrated in Fig. 3. The controller generates voltage signals to the front and back motors in order to steer the helicopter body to a desired point in the workspace (which is given in terms of reference values for the elevation and travel angles).

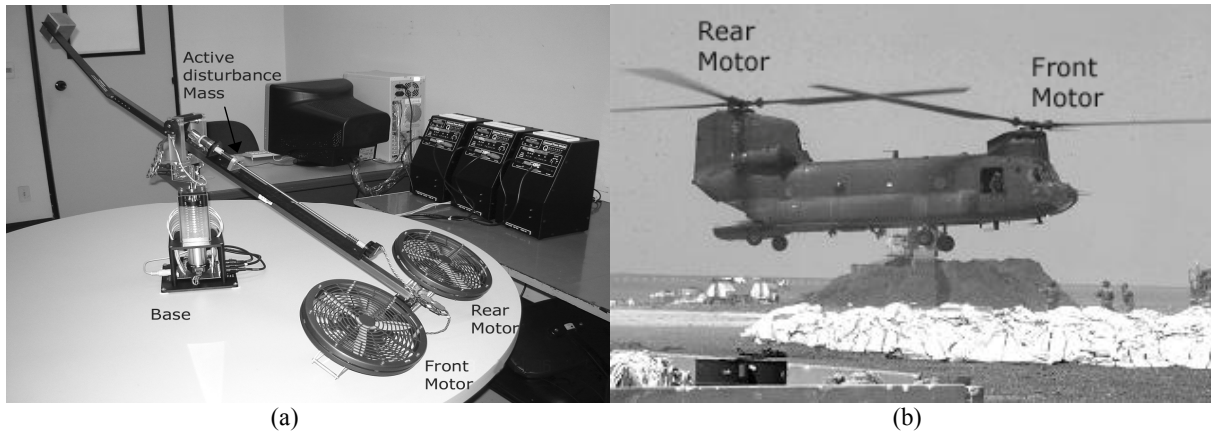

Figure 2. (a) The 3DOF Helicopter system. (b) CH-47 Chinook Helicopter (Milhan, 2006).

The helicopter dynamics can be described by a 6th order model with states corresponding to the angles of Elevation (E), Travel (T), Pitch (P) and their respective rates (\dot{E} , \dot{T} , \dot{P}).

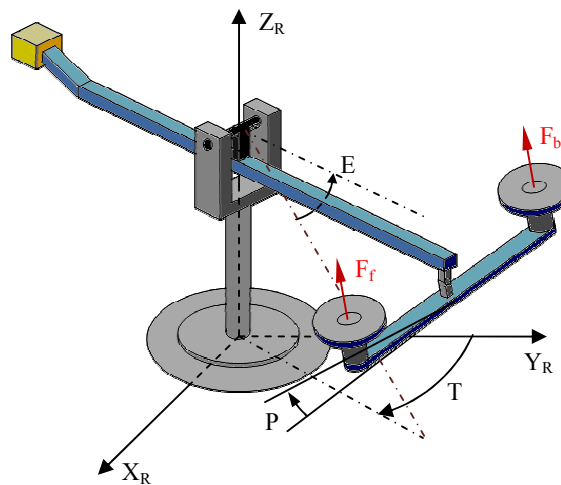

Figure 3. Mechanical setup of the 3DOF helicopter.

3. A FAULT DETECTION SCHEME BASED ON K-MEANS CLUSTERING

Processes engineering usually contain both event normal and abnormal data in n -dimensional space, making it difficult to segregate manually. In this work, k-means clustering (Duda *et al.*, 2001) is used to determine regions that reflect adequately the normal operating signature from system input-output data acquired. Choosing a data set of relevant variables is an important first step towards to machine learning (Mitchell, 1997). Such a step is necessary to improve the performance of the method.

The reduction in the gain of one of the motors affects the dynamics of the system. Thus, just the inputs and outputs are not enough to represent a dynamic system behavior, so a rate information is also needed. The data sets used in this experiment were: reference signals, input signals, output signals and rate information of the output signals. In this study, a fault applied at different instants have been considered. The description of variables is discussed in more detail in Section 4.2.

The basic idea behind k-means clustering is group samples, composed of input-output vectors, so as maximize separability between these groups. Consider $X \in \mathfrak{R}^{m \times n}$, a set of m samples in n -dimensional space \mathfrak{R}^n , formed by

hyper-spheres in which contains the variables joint trajectories during normal operating conditions. The number of clusters k is assumed to be fixed in k-means clustering, and the problem is to determine a set of its k centroids in $\mu_1, \mu_2, \dots, \mu_k$ in \mathcal{R}^n . The k-means method partitions the samples in the data set into mutually exclusive clusters. The clusters represent regions in the n -dimensional space composed by system variables without presence of faults.

The number of clusters needs to be determined at the onset. However, worth emphasizing that the appropriate choice of k clusters is a problem and generally the user tries several values of k (Alsabti, 1999). Following the proposed in Matsuura (2006), in this work, 200 clusters is assumed to be fixed in k-means clustering.

The normal behavior of the system is verified by calculating the Euclidean distance from each set of measurements to the centroids of the learned clusters. It can be seen that one of the major advantages of using the Euclidean distance measure is that the computational cost is very low.

During process supervision, vectors that are contained or close to the regions formed by k-means algorithm is a indicate of normal operation of the system. Vectors distant of these regions indicate an abnormal situation, which may be the occurrence of a failure Matsuura (2006).

To assess whether the vectors are presented during the supervision are or not contained in these regions is necessary to compare with a fixed threshold. Therefore, a threshold (1.0 in this work) is used in the supervision.

The vectors that are close to one of the centers of the groups learned, in other words, vectors whose distances to the nearest cluster center are smaller than the threshold are considered as indicators of normal operation, while vectors whose distances to the center of the closest group are greater than the threshold are considered as indicators of the occurrence of failure in the system (Matsuura, 2006).

Choosing the threshold too low increases the rate of false alarms. On the other hand, choosing it too large make that some faults can not be detected (Frank, 1990). It is noteworthy, however, that the correct choice of the evaluation threshold can not be trivial. In somewhat similar work, Matsuura (2006) have discussed the use of thresholds and illustrates cases where the threshold might hamper the detection of possible failures and the generation of false alarms.

The basic aim to fault detection is to register an alarm immediately following the advent of a fault. Direct application of the above algorithm would yield a high number of false alarms (false positives). The way to improve the conditions for the detectability and distinguishability of a fault is to signal an alarm after a minimum number of violations overcome the threshold. Some earlier work that use evaluation thresholds criterion to distinguish a fault can be found in Patton *et al.*(1989) and Frank(1990).

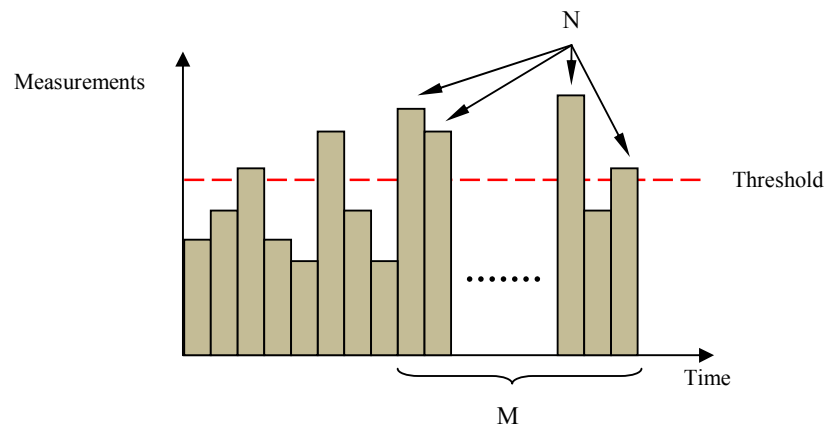

Figure 4. An alarm is generated when the N points exceed threshold in M samples.

The evaluation thresholds criterion aims to make the false alarm as small as possible and improve the performance of the fault detection system. The false alarms rate is an indication of alarms that did not correspond to an actual event.

In particular, the algorithm generates an alarm when the measurements of N points exceed some threshold for a number of samples M , as illustrated in Fig. 4. It worths emphasizing that the algorithm considers only violations of the threshold. An alarm is generated after a minimum number of violations overcome the threshold computed over a past time window.

Consider N a sequel of points for a M number of samples (the parameter considered is $M = 5$). If 2 sample points exceed the threshold, than a fault is launched. This fault analyses is madden continuum, for that a moving window was implemented. This window contains a M number of samples. The analysis begins 1.5s before the fault and ends 1.5s after. The fault instant is used in the following cases:

- 1) To analyze just some instants before and some after the fault. The analyses time do not have to be long, so if the fault do not be detected soon, is worthless.
- 2) Verify if the method was capable of detect the fault (launch an alarm after the fault occurrence) and what was the method delay (how much time passed since the simulated fault until the method launches the alarm).

The results (Section 4.2) show that although simpleness and straightforwardness, the technique presented, can exhibit good performance for fault detection.

4. EXPERIMENTAL RESULTS

4.1. Materials

For fault detection, the 3 DOF pilot-plant was operated as a closed loop system and the following materials were used.

- Microcomputer equipped with Pentium IV 3.0GHz, 1 GHz of memory RAM and operating system Windows XP;
- Software Quanser Wincon 5.0/Build 21: real time control with Matlab/Simulink 7.0 designed for Windows XP;
- Hardware for data acquisition Q4 from Quanser Consulting;
- Software Matlab/Simulink version 7.0.4.3.65(R14) Service Pack 2.

The training for normal operating conditions was realized with K-means algorithm (Duda et al., 2001) using the Statistics Toolbox from Matlab 7.0.

4.2. Data Set Description

The control was realized with 1ms of sampling time. As mentioned before, the control variables are the elevation (E) and travel (T) angles. Thus, the reference signals for k-means clustering and fault detection are the elevation (E_{Ref}) and travel (T_{Ref}). For data acquisition, a train of rectangular pulses with 20 seconds period it is implemented, equally spaced and with 10 degrees of amplitude. Adding a constant value of 25 degrees, lead the elevation angle to vary between 25 and 35 degrees, as show in Fig 5. The travel reference (T_{Ref}) is maintained with constant value zero, as show Fig 5. Additionally, the input signals (motors voltages), presented on Fig. 6, and output signals elevation, travel and pitch of the system are presented on Fig 5. The angle velocities (\dot{E} , \dot{T} , \dot{P}) were obtained after the application of a low-pass filter.

The fault under consideration consists of a 10% reduction in the gain of one of the motors. The faults were applied with duration of 5s.

The reference signal is pre-filtered to avoid that the helicopter makes sudden movements. Thus, a low-pass filter with 5 rad/s break frequency and unit static gain is used.

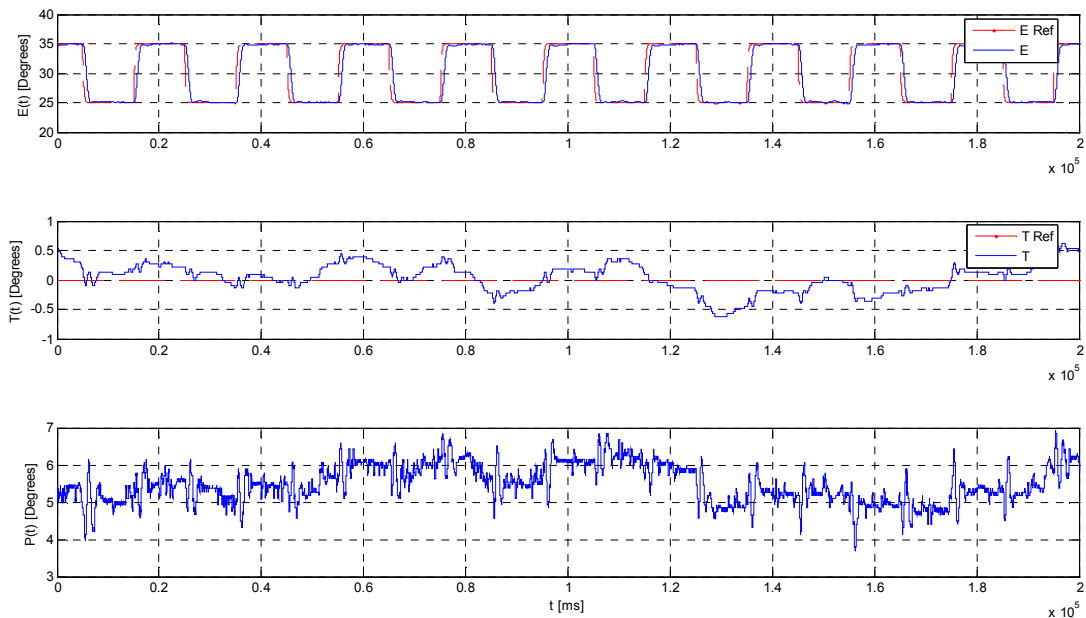

Figure 5. Signals from the encoders for three-degree-freedom

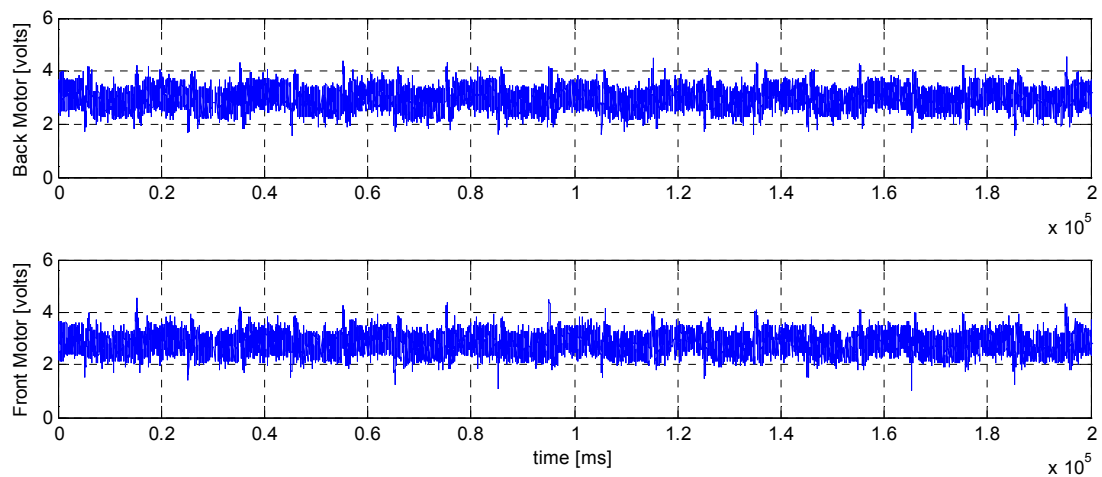

Figure 6. Voltages applied to the front and back motors.

4.3. Results of fault detection

In the study of the fault detection, a fault of the motor during the climb and descent procedures is considered. A total of 170 faults were simulated at different instants, being 85 faults in the climb and 85 faults in the descent. The fault under consideration consists of a 10% reduction in the gain of one of the motors.

The performance of threshold methods for detect faults directly depends on the correct choice of that threshold, as much in case of analytical redundancy as in case of the proposed method. Thus, a comparison between the methods with fixed thresholds could be tendentious. The ROC curves can be used to overcome the threshold choices problem for comparison purposes.

The receiver operating characteristic (ROC) curve, which is defined as a plot of test sensitivity as the y coordinate versus its 1-specificity or false positive rate (FPR) as the x coordinate, is an effective method of evaluating the quality or performance of diagnostic tests. (Park *et. al.*, 2004).

For performance comparison of different detection faults methods, the ROC curves can be built varying the threshold since the least rate of false alarms until the biggest rate of correct detections. With the rates of correct detection and false alarms different for these thresholds, the ROC curve can be built for each fault detection method.

One of the most popular measures is the area under the ROC curve (AUC) and can be found in Vemuri *et al.*(2001), Park *et al.*(2004), Faraggi and Reiser (2002). AUC is a combined measure of sensitivity and specificity. AUC is a measure of the overall performance of a diagnostic test and is interpreted as the average value of sensitivity for all possible values of specificity. The closer AUC is to one, the better the overall diagnostic performance of the test, and a test with an AUC value of one is one that is perfectly accurate.

For false alarms occurrence, correct detection and consequently built of ROC curves, was considered an operation period before the fault occurrence and other after.

The Fig. 7 presents ROC curve for the proposed method and Analytical Redundancy ROC curve for the three output signals (pitch, elevation and travel)

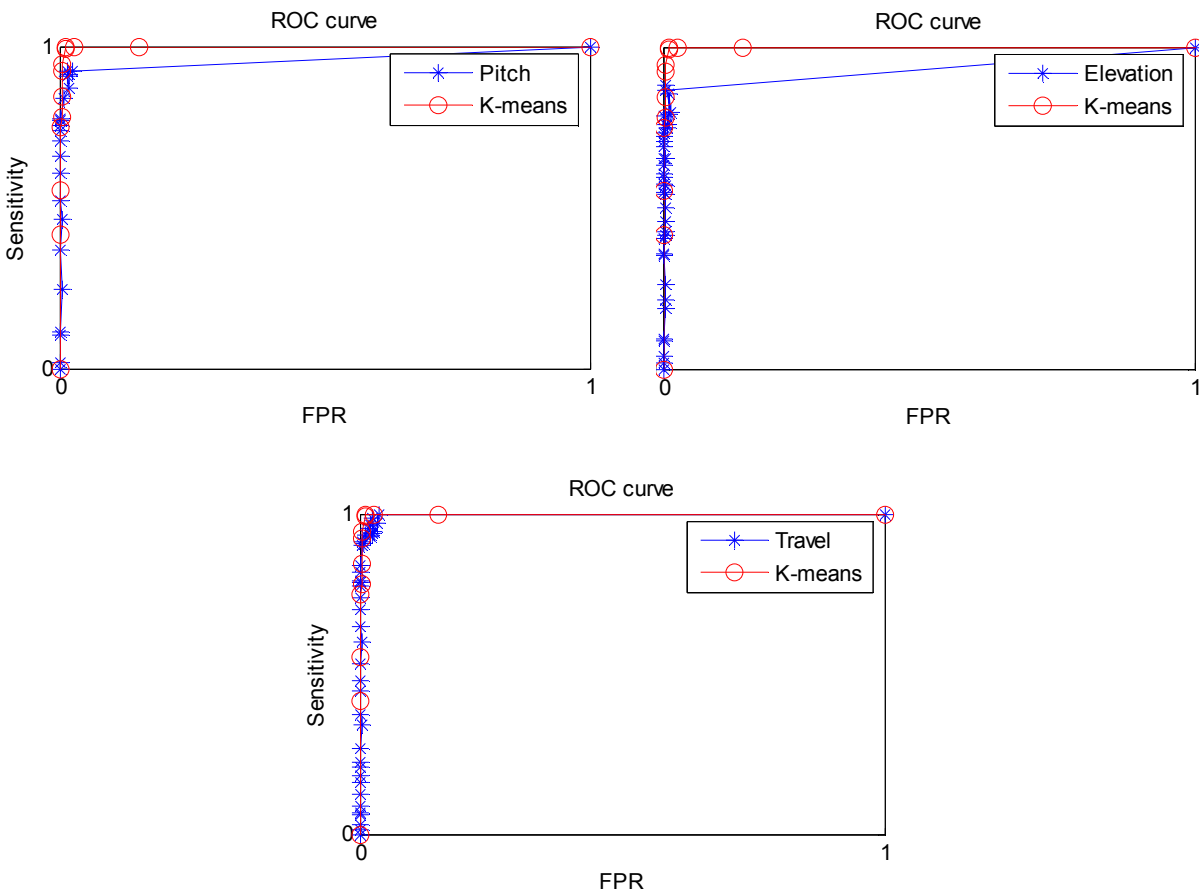

Figure 7. K-means ROC curve and Analytical Redundancy ROC curve for the three output signals

It can be noted that the proposed method presents a better ROC curve than the analytical redundancy with all the three output variables. Table 1 shows the AUC values.

Table 1. AUC values.

ROC Curve	AUC
K-Means	0.99
Analytical redundancy: Elevation	0.93
Analytical redundancy: Pitch	0.96
Analytical redundancy: Travel	0.99

Table 2 show the mean detection time for both cases for a fixed threshold. To calculate the mean detection time is considered only in cases of correct detection. The detection time is the time between the occurrence of the fault and the detection based on k-means algorithm.

Table 2. Detection time.

Method	Time
K-Means	0.63s
Analytical redundancy	2.3s

Note that the time necessary to detect a fault in the proposed method is more then three times faster than the analytical redundancy method. By analyzing the proposed method all the 170 faulty situations and 170 situations of normal operation, all faults were correctly detected and two false alarms were triggered.

5. CONCLUSIONS

In this paper, we presents the results of a fault detection scheme using k-means clustering. In the proposed approach, the k-means algorithm is applied in unsupervised learning of patterns from system input-output data acquired under normal operating conditions. The normal behavior is verified by calculating the Euclidean distance from each set of measurements to the centroids of the learned clusters. This means that the computational cost of the detection algorithm is low.

The results in terms of detection delay and ROC (Receiver Operating Characteristic) curve indicate that the method has good potential when compared with analytical redundancy using a wavelet filter bank, with the advantage of not requiring an analytical model of the system and without necessarily being complex or costly to implement.

6. ACKNOWLEDGEMENTS

This work was supported by FAPESP (Fundação de Amparo à Pesquisa do Estado de São Paulo) under grant 2006/58850-6. The first author was supported by CAPES (Fundação Coordenação de Aperfeiçoamento de Pessoal de Nível Superior). The second and fourth authors were supported by CNPQ (Conselho Nacional de Desenvolvimento Científico e Tecnológico).

7. REFERENCES

- Alsabti, k., Ranka, S. and Singh, V., 1999, "An Efficient Space-Partitioning Based Algorithm for the K-Means Clustering", Springer Berlin / Heidelberg, Lecture Notes in Computer Science Series, Vol.1574/1999, pp. 355-360.
- Angeli, C. and Chatzinihilau, A., 2004, "On-line fault detection techniques for technical systems: a survey". International Journal of Computer Science & Applications, Vol.1, No. 1, pp. 12-30.
- Alsabti, k., Ranka, S. and Singh, V., 1999, "An Efficient Space-Partitioning Based Algorithm for the K-Means Clustering", Vol.1574, pp. 355-360.
- Capriglione, D.; Liguori, C.; Pietrosanto, A., 2004, "Analytical redundancy for sensor fault isolation and accommodation in public transportation vehicles". IEEE Trans. Instrumentation and Measurement, Vol.53, No. 4, pp. 993- 999.
- Chien, C. F.; Chen, S. L. and Lin, Y. S., 2002, "Using Bayesian network for fault location on distribution feeder". IEEE Transactions on Power Delivery, Vol.17, No. 13, pp. 785-793.
- Cordier, O., Dague, P., Levy, F., Montmain, J., Staroswiecki, M. and Trave-Massuyes, L., 2004, "Conflicts versus analytical redundancy relations", IEEE Trans. Systems, Man, and Cybernetics, Part B, Vol.34(5), pp. 2163- 2177.
- Cybenko, G., 1989, "Approximation by superpositions of a sigmoidal function. Mathematics of Control, Signals and Systems", 303-314.
- Duda, R. O.; Hart, P. E. and Stork, D. G., 2001, Pattern Classification, New York: Wiley.
- Faraggi, D. and Reiser, B., 2002, "Estimation of the area under the ROC curve. Statistics in Medicine", No. 21, pp. 3093-3106.
- Fekih, A., Xu, H., and Chowdhury, F., 2007, "Neural networks based system identification techniques for model based fault detection of nonlinear systems", Int. J. Innovative Comput., Inf. Control, Vol.3, pp. 1073-1085.
- Frank, P.M., 1990, "Fault diagnosis in dynamic systems using analytical and knowledge-based redundancy - A survey, Automatica", Vol.26, pp. 459-474.
- Gertler, J., 1998, Fault Detection and Diagnosis in Engineering Systems. Marcel Dekker, New York.
- Hoskins, J. C., Kaliyur, K. M., and Himmelblau, D. M., 1991, "Fault diagnosis in complex chemical plants using artificial neural networks". American Institute of Chemical Engineers Journal, Vol.37, No. 1, pp. 137-141.

- Isermann, R., Schwarz, R. and Stolzl, S., 2000, "Fault-tolerant drive-by-wire systems-concepts and realization," in Proc. IFAC Symp. Fault Detection, Supervision and Safety for Technical Processes: SAFEPROCESS, pp. 1-15
- Li, Q. and Bernard, J. A., 2002, "Design and evaluation of an observer for nuclear reactor fault detection", IEEE Trans. Nuclear Science, Part 2. Vol.49, No. 3, pp. 1304-1308.
- Marcos, A., Ganguli, S. and Balas, G. J., 2005, "An application of H1 fault detection and isolation to a transport aircraft", Control Engineering Practice. Vol.13, No.1, pp. 105-119.
- Matsuura, J. P., 2006, "Detecção de Falhas em Sistemas Dinâmicos com Redes Aprendidas a partir de Estimação de Estados", Ph.D. thesis, Instituto Tecnológico de Aeronáutica- ITA, São José dos Campos.
- Milhan, A. P., 2006, "Detecção de falhas empregando identificação em subespaços e análise wavelet". XVI Proceedings of the Congresso Brasileiro de Automática – CBA.
- Mitchell, T. M., 1997, Machine Learning. New York, McGraw-Hill series in computer science.
- Paiva, H.M., 2003, Detecção de Falhas em Sistemas Dinâmicos Empregando Transformadas Wavelet Adaptativas. M.Sc. dissertation, Instituto Tecnológico de Aeronáutica- ITA, São José dos Campos.
- Park, S. H., Goo, J. M. and Jo, C. H., 2004, "Receiver operating characteristic (ROC) curve: practical review for radiologists". Korean Journal of Radiology, No. 5, p. 11-18.
- Patton, R. J. and Chen, J., 1992, "A robustness study of model-based fault detection for jet engine systems". IEEE Conf. on Control Application, 1., Vol.2, pp. 871-876.
- Patton, R.J., Chen, J., and Siew, T.M., 1994, "Fault diagnosis in nonlinear dynamic systems via neural networks". IEEE Conf. on Control Application, Vol. 2, pp. 1346-1351.
- Patton, R., Frank, P.M. and Clark, R. N., 1989, Fault Diagnosis in Dynamic Systems: Theory and Application, Prentice Hall.
- Patton, R., Frank, P.M. and Clark, R. N., 2000, Issues in fault diagnosis for dynamic systems. London: Springer.
- Polycarpou U, M. M.; Helmicki, A. J., 1995, "Automated fault detection and accommodation: A learning systems approach". IEEE Trans. Systems, Man, and Cybernetics, Vol.25, No. 11, pp. 1447-1458.
- Quanser Consulting Inc., 2005, 3D Helicopter System: With Active Disturbance [S.1.]: Quanser Inc., User Manual. CD-ROM.
- Riascos, L. A. M.; Simões, M. G.; Miyagi, P. E., 2005, "Fault identification in fuel cells based on Bayesian network diagnosis". Congresso Int. de Mechanical Engineering, pp. 1-8, Ouro Preto.
- Ulerich, N. H. and Powers, G. J., 1988. On-line hazard aversion and fault diagnosis in chemical processes, IEEE Trans. Reliability, Vol.37, No. 2, pp. 171-177.
- Ungar, L. H., Powell, B. A., and Kamens, S. N., 1990, "Adaptive networks for fault diagnosis and process control". Computers and Chemical Engineering Vol.14 (4 -5), pp. 561-572.
- Vaidyanathan, R., and Venkatasubramanian, V., 1992, "Representing and diagnosing dynamic process data using neural networks". Engineering Applications of Artificial Intelligence, Vol.5, No. 1, pp. 11-21.
- Vemuri, A. T., Polycarpou, M. M. and Ciric, A. R., 2001, "Fault diagnosis of differential-algebraic systems". IEEE Transactions on Systems, Man and Cybernetics, Part A, Vol. 31, No. 2, pp. 143-152.
- Venkatasubramanian, V., Rengaswamy, R., Kavuri, S. N. and Yin, K., 2003a, "A review of process fault detection and diagnosis part I: quantitative model-based methods". Computers and Chemical Eng., Vol.27, pp. 293-311.
- Venkatasubramanian, V., Rengaswamy, R., Kavuri, S. N. and Yin, K., 2003b, "A review of process fault detection and diagnosis part II: quantitative models and search strategies". Computers and Chemical Eng., Vol.27, pp.313-326.
- Venkatasubramanian, V., Rengaswamy, R., Kavuri, S. N. and Yin, K., 2003c, "A review of process fault detection and diagnosis part III: process history based methods". Computers and Chemical Eng., Vol.27, pp. 327-346.
- Venkatasubramanian, V., and Chan, K., 1989, "A neural network methodology for process fault diagnosis". American Institute of Chemical Engineers Journal, Vol.35, No. 2, pp. 1993-2002.
- Zhong, M., Ye H., Ding S. X., and Wang G., "Observer-based fast rate fault detection for a class of multirate sampled-data systems," IEEE Trans. Autom. Control, Vol. 52, No. 3, pp. 520–525, Mar. 2007.

8. RESPONSIBILITY NOTICE

The authors are the only responsible for the printed material included in this paper.